

# AKROFF

> **TUBI FLESSIBILI**  
per Freno e Frizione

> **HYDRAULIC BRAKE**  
and Clutch Hoses



CATALOGO  
CATALOGUE

**0113**

**TecDoc**  
CERTIFIED DATA SUPPLIER

  
**MALÒ**  
[www.malospa.it](http://www.malospa.it)



**MALÒ S.P.A.**

ORGANIZZAZIONE CON SISTEMA  
DI GESTIONE QUALITÀ CERTIFICATO  
UNI EN ISO 9001 : 2000 - CERTIFICATO N° 547

**Sede Legale, Uffici, Magazzino Centrale:**

Via Tagliamento, 8  
20098 S. Giuliano Milanese (MI)  
Fraz. Sesto Ulteriano - Italia  
Tel. +39.02.98.29.781 (r.a.)  
Fax +39.02.98.28.19.18  
Fax Vendite Italia +39.02.98.81.019  
Fax Import-Export +39.02.98.81.018  
[www.malospa.it](http://www.malospa.it)  
e-mail: [Info@malospa.it](mailto:Info@malospa.it)

**CATALOGO GRATUITO**

Le denominazioni ed i riferimenti a prodotti e costruttori hanno esclusivo valore indicativo. I nostri prodotti non sono originali, ma ad essi perfettamente intercambiabili. Questo catalogo è stato realizzato da Malò S.p.a. La riproduzione totale o parziale di questo catalogo è assolutamente proibita senza il nostro permesso scritto.

Vehicle manufacturers and component suppliers part numbers are listed for information and comparison purposes only. Our products are not original equipment, but can however be interchanged. This catalogue is produced by Malò S.p.a. All reproduction in whole, or in part is forbidden without our written permission.

L'azienda nasce nel 1947 nel piccolo magazzino seminterrato in Via Frappolli a Milano.

Nel 1952 Aldo Malò, rilevata la società, decide di concentrarsi sul mercato italiano, del quale è stato pioniere, portando l'azienda, negli anni, a costruire una solida presenza sul territorio, rivelatasi un enorme vantaggio competitivo.

La lunga strada intrapresa porta, nel 1999, Malò a trasformarsi in S.p.A. e ad espandersi nei mercati esteri.

Malò ha sempre indirizzato i suoi sforzi al miglioramento qualitativo e all'ampliamento della gamma dei suoi prodotti, facendo di tutto per soddisfare le esigenze dei propri clienti.

La soddisfazione del cliente per Malò è molto più che offrire una gamma di prodotto completa e d'alta qualità.

Significa anche disporre i magazzini in maniera strategica sul territorio per assicurare una distribuzione capillare.

Significa avvalersi della competenza degli oltre 100 operatori della Sede Centrale e della rete vendita, per fornire un'assistenza pre e post vendita continua.



The company started in 1947 in the basement of the small warehouse located in Via Frappolli in Milan.

In 1952 Mr. Malò took over the firm concentrating on the development of the Italian market and building a solid presence over the territory, revealing itself to be an enormous competitive advantage. The long undertaking journey brought Malò in 1999 to turn from Ltd. to a Joint-Stock and expand towards foreign countries.

Since the very beginning Malò's strategy has always been focused on a constant improvement to grant our customers quality products and services.

Customer satisfaction for Malò is much more than offering a wide range of high quality Products. It's also providing strategically located deposits which enable to cover all the territory and to quickly despatch more than 30 million of pieces per year. It means offering a service, which gives a big support and a suitable pre and post sales assistance, granted by over a 100 people members of our team.



**ELEMENTI DI TENUTA AKRON**

Anelli di tenuta per alberi rotanti, a tenuta idrodinamica unidirezionale e bidirezionale per tutte le applicazioni su autoveicoli e veicoli industriali. In gomma nitrilica, poliaccrilica, siliconica e fluorurata. Anelli O - Ring e guarnizioni per tenute dinamiche. Guarnizioni di tenuta per alberi pompa acqua.

**PRODOTTI IN GOMMA E GOMMA METALLO AKRON**

Supporti motore. Boccole elastiche. Anelli e supporto per tubi di scarico. Paracolpi sospensione. Boccole e supporti ammortizzatori. Cuffie per semiassi, giunti omocineticici e per scatole guida. Cuffie leva cambio, copripedali. Guarnizioni per asta valvole. Supporti elastici per carburatore. Giunti flessibili per alberi trasmissione.

**MANICOTTI E TUBI AKRON**

Manicotti con inserto tessile ed in sola gomma per radiatore ed impianto di riscaldamento. Manicotti e tubi per passaggio carburante. Tubi flessibili con spirale metallica per passaggio aria. Tubi in plastica per carburante e lavavetro. Tubi in plastica e carta alluminio per condizionamento vettura. Tubo radiatore e impianti di riscaldamento, in rotoli. Tubi flessibili per passaggio olio. Tubi in silicone.

**COMANDI IDRAULICI FRENI E FRIZIONE AKRON**

Cilindri maestri e secondari comando freni e frizioni idrauliche. Serie guarnizioni per riparazione cilindri maestri, secondari e pinze freno a disco.

**TUBI FRENO AKRON**

Tubi per freni e frizioni idrauliche. Tubi per freni ad aria e servocomandi.

**COMANDI FLESSIBILI E TRASMISSIONI CONTACHILOMETRI AKRON**

Per freno a mano e frizione, acceleratore, apertura cofano, aria carburatore, motorino di avviamento.

**PULEGGE SMORZATRICI AKRON****VARIE**

Tubi flessibili per comando servosterzi e guide idrauliche.

Tubi per comandi oleodinamici.

Fascette in plastica per cablaggi e cuffie cremagliere sterzo.

Fascette in acciaio per cuffie giunti omocineticici.

Fascette stringitubo.



## AKRON OIL SEALS

Oil seals for automotive and industrial application in NBR, poliacrilic, Silicon and viton compounds.

## AKRON RUBBER AND RUBBER METAL PARTS

Engine mounts, silent-blocks shock absorber rubber parts. Strut mounts, c.v.boots, steering boots, carburettor and injection mounts, drive shaft mounts ecc.

## AKRON RUBBER HOSES

Radiator and hating hoses with textile insertion or plain rubber. Fuel and oil hoses. Air hoses. Silicon hoses. Paper-Aluminium and plain aluminium air hoses. Plastic pipes for fuel or wipers.

## AKRON HYDRAULIC BRAKE PARTS

Master and wheel brake cylinders. Master and slave clutch cylinders. Rubber repair kits for cylinders and calipers.

## AKRON HYDRAULIC BRAKE AND CLUTCH HOSES

Hydraulic brake and clutch hoses. Pneumatic brake hoses.

## AKRON FLEXIBLE CABLES

For Clutch, hand brake, speedometer, accelerator, choke and bonnet.

## AKRON DUMPERS

## VARIOUS

Power steering flexible hoses. Hydraulics hoses. Plastic clamps for steering boots application. Plastic clamps for eletric wiring application. Stainles steel clamps for c.v. joints boots. Radiator hoses clamps



Lo sviluppo aziendale è anche il risultato degli accordi commerciali con importanti gruppi internazionali quali:



**PASTIGLIE - DISCHI - GANASCE  
TAMBURI FRENO - SUPERKIT  
(DISTRIBUTORE ESCLUSIVO NAZIONALE)**



**CINGHIE DI TRASMISSIONE  
(DISTRIBUTORE NAZIONALE)**

Cinghie distribuzione, cinghie trapezoidali, cinghie pluri - ribb, tendicinghia e kit tendicinghia. Kit pompe acqua. Pulegge Smorzatrici.



**ORGANI DELLA TRASMISSIONE  
(DISTRIBUTORE NAZIONALE)**

Kit giunti omocinetici e semiasse completi.



**POMPE ACQUA  
(DISTRIBUTORE NAZIONALE)**

The company development as the primary business lever.

It is achieved throughout trade agreements with important international companies such as



**BRAKE PADS - DISCS - SHOES  
DRUMS - SUPERKIT  
(EXCLUSIVE ITALIAN DISTRIBUTOR)**



**POWER TRANSMISSION BELTS  
(ITALIAN DISTRIBUTOR)**

Fan belts, timing belts and poly-v belts Tensioner kits. Water Pumps Kits. Dumpers.



**AUTOMOTIVE TRANSMISSION PARTS  
(ITALIAN DISTRIBUTOR)**

Drive shafts and CV joint kits.



**WATER PUMPS  
(ITALIAN DISTRIBUTOR)**



SCANDINAVIAN SHOCK SYSTEMS



automotive



**COMANDI IDRAULICI FRENI E FRIZIONE  
(DISTRIBUTORE NAZIONALE)**

Cilindri maestri e secondari comando freni e frizioni idrauliche. Serie guarnizioni per riparazione cilindri maestri, secondari e pinze freno a disco.



**CUSCINETTI  
(DISTRIBUTORE NAZIONALE)**

KIT Cuscinetti ruota.  
Cuscinetti tenditori distribuzione. Cuscinetti tenditori organi ausiliari. Ruote libere alternatore.



**HYDRAULIC BRAKE PARTS  
(ITALIAN DISTRIBUTOR)**

Master and wheel brake cylinders.  
Master and slave clutch cylinders.  
Rubber repair kits for cylinders and calipers.



**BEARINGS  
(ITALIAN DISTRIBUTOR)**

Wheel bearing Kits. Belt tensioner pulley for power transmission.  
Belt tensioner pulley for auxiliary power transmission.  
Wheel bearing kits and alternator pulley.

# www.malospa.it

per consultare il catalogo  
aggiornato in tempo reale  
ed effettuare gli ordini  
on line!





# www.malospa.it

you can consult our catalogue  
updated in real time  
and buy on line!





 **Marca e modello veicolo**  
**Vehicle manufacturer and model**  
**Constructeur et modèle**  
**Fahrzeughersteller und modell**  
**Fabricante y modelo**

 **Lunghezza totale**  
**Total length**  
**Longueur totale**  
**Gesamtlänge**  
**Longitud total**

 **Intercambiabile col numero**  
**Interchangeable with**  
**Interchangeable avec**  
**Austauschbar mit**  
**Intercambiables con**



 **Anno di produzione**  
**Year of manufacture**  
**Année de production**  
**Baujahr**  
**Año de fabricación**

 **Riferimento AKRON**  
**AKRON part number**  
**Ref. AKRON**  
**AKRON - Teilnummer**  
**Referencia AKRON**

 **Posizione di installazione**  
**Installation position**  
**Position d'installation**  
**Einbauposition**  
**Posición de montaje**

 **Tipo di raccordo**  
**Fitting type**  
**Types d'embouts**  
**Anschluss Typ**  
**Tipos de raccors**

**TRADUZIONI      TRANSLATIONS      TRADUCTION      ÜBERSETZUNGEN      TRADUCCIONES**

Catalogo					
(4 Marce) (5 Marce) (alla pinza) (alla pompa freno) (Berlina) (- Carico maggiorato) (Carico maggiorato) (Centrale) (Circuito Doppio) (Circuito Semplice) (Dischi Ant/Post) (Dischi pieni) (Dischi ventilati) (Disco Post.) (Disco) (Freno a Disco) (Freno a mano elettrico/elettronico) (Freno a tamburo) (Imp) (Inferiore) (Intermedio) (interno) (Passo Corto) (Passo Lungo) (Pianale Piatto) (Pinza) (Pinza ATE) (Pinza Lucas) (Pinza freno a 2 pistoni) (Pinza freno a 4 pistoni) (Pinza freno ant. impianto diagonale) (Pinza freno flottante) (ruota a 3 fori) (ruota a 4 fori) (Ruote 15") (Ruote 16") (Ruote 17"-18") (Ruote gemellate) (+ Segnalatore d'usura) (Senza correttore) (Servofreno) (Superiore) (Tamburo) (Tamburo a 3 fori) (Tamburo a 4 fori) (Tamburo Post) (TT) (TT/BZ) (TT/DS) (TT/SW)  (Tubazioni separate diagonalmente) (Tubazioni separate verticalmente) (Vett. Con Check Control)	Cambio a 4 marce Cambio a 5 marce alla pinza freno alla pompa freno Berlina Senza Carico maggiorato Carico maggiorato Centrale Circuito Doppio Circuito Semplice Freno a disco anteriore/posteriore Disco freno pieno Disco freno ventilato Freno a disco posteriore Disco freno Freno a disco Freno a mano elettrico/elettronico Freno a tamburo Impianto Inferiore Intermedio Interno Passo Corto Passo Lungo Pianale Piatto Pinza freno Pinza freno ATE Pinza freno Lucas Pinza freno a 2 pistoni Pinza freno a 4 pistoni Pinza freno anteriore - impianto diagonale Pinza freno flottante Ruota a 3 fori Ruota a 4 fori Ruote 15" Ruote 16" Ruote 17"-18" Ruote gemellate con segnalatore d'usura Senza correttore Servofreno Superiore Tamburo freno Tamburo a 3 fori Tamburo a 4 fori Freno a tamburo posteriore Tutti i tipi Tutti i tipi vetture benzina Tutti i tipi vetture diesel Tutti i tipi vetture station-wagon  circuito freno diagonale circuito freno parallelo Vetture con check control	4 speed transmission 5 speed transmission on brake caliper to brake master cylinder Saloon w/o Increased payload Increased payload Central Dual circuit Single circuit front/rear disc brake Brake disc solid Brake disc ventilated Rear disc brake Brake disc Disc brake Electronic handbrake Drum brake Installation Lower Intermediate Inside Shortened wheelbase Extended wheelbase Platform Brake caliper Brake caliper ATE Brake caliper Lucas Caliper with 2 pistons Caliper with 4 pistons Front Caliper with 4 pistons diagonal equipment Floating caliper Wheel with 3 holes Wheel with 4 holes Wheels 15" Wheels 16" Wheels 17"-18" Dual tyres with wear and tear signaller without calibrator Power brake booster Upper Brake drum Brake drum with 3 holes Brake drum with 4 holes Rear drum brake All models All petrol models All diesel models All station-wagon models  diagonal brake circuit parallel brake circuit cars with check-control	boite à 4 vitesses boite à 5 vitesses à l'étrier au maître-cylindre Berline Sans Charge utile augmentée Charge utile augmentée Central Double circuit Simple circuit Frein à disque avant/arrière Disque de frein ventilé Disque de frein ventilé Frein à disque arrière Disque de frein Frein à disque Frein d'arrêt électronique Frein à tambour Installation Inférieur Intermédiaire Intérieur Empattement court Empattement rallongé Plate-forme Étrier Étrier ATE Étrier Lucas Étrier avec 2 pistons Étrier avec 4 pistons Étrier ant.installation diagon.  Étrier flottant Roue avec 3 trous Roue avec 4 trous Roues 15" Roues 16" Roues 17"-18" Pneus doubles avec Signaleur d'usage Sans correcteur Servofrein Supérieur Tambour de frein Tambour de frein avec 3 trous Tambour de frein avec 4 trous Frein à tambour arrière Tous les modèles Tous les modèles essence Tous les modèles diesel Tous les modèles break  circuit de frein diagonal circuit de frein parallèle voitures avec check-control	4 Ganggetriebe 5 Ganggetriebe am Bremsattel Berline Ohne erhöhte nutzlast Erhöhte nutzlast Zentrale Zweikreis Einkreis Scheibenbremse vorn/hinten Brems Scheibe nicht belüftet Brems Scheibe belüftet Scheibenbremse hinten Brems Scheibe Scheibenbremse Elektronische feststellbremse Trommelbremse Anlage Unten Intermediate Innen Verkürzter radstand Verlängerter radstand Pritsche Bremsattel Bremsattel ATE Bremsattel Lucas Bremsattel mit 2 kolben Bremsattel mit 4 kolben Bremsattel vorn mit 4 Kolben (Queranlage) Schwimmsattel Rad mit 3 Locher Rad mit 4 Locher Rader 15" Rader 16" Rader 17"-18" Doppelbereifung Mit Verschleißmelder Ohne Korrektor Bremsgerät Oben Trommel Trommel mit 3 Locher Trommel mit 4 Locher Trommelbremse hinten Alle modelle Alle Benzinmodelle Alle Dieselmmodelle Alle Kombiwagenmodelle  diagonales Bremsleitungssystem schwarz/weiß-Aufteilung der Bremskreise Wagen mit Check-Kontrolle	transmission con 4 velocidades transmission con 5 velocidades a la pinza de freno a los cilindro maestro Berlina Sin Carga util incrementada Carga util incrementada Central Circuito doble Simple circuito Freno de disco delantero/trasero Disco de freno no ventilado Disco de freno ventilado Disco de freno trasero Disco de freno Disco de freno Freno de detención electrónico Tambores de freno Equipo Inferior Intermedio Interior Distancia entre rueda accortada Distancia entre rueda prolongada Caja Pinza de freno Pinza de freno ATE Pinza de freno Lucas Pinza de freno de 2 pistones Pinza de freno de 4 pistones Pinza de freno circuito de freno diagonal Pinza de freno flotante Rueda con 3 agujeros Rueda con 4 agujeros Ruedas 15" Ruedas 16" Ruedas 17"-18" Neumáticos gemelos con indicador de desgaste Sin regulador Servo-freno Superior Tambor de freno Tambor de freno con 3 agujeros Tambor de freno con 4 agujeros Freno de tambor trasero Todos modelos Todos modelos bencina Todos modelos diesel Todos modelos familiar  circuitos de freno en diagonal circuitos de freno paralelo Vehiculo con check-control

## Nuovi prodotti

Nuovi prodotti/New products ————— da pag. 1 a pag. 12

## Tubi flessibili per freno / Brake hoses

Alfa Romeo	da pag. 15 a pag. 22
Audi	da pag. 23 a pag. 31
Bedford	da pag. 32 a pag. 32
Bmw - Mini	da pag. 33 a pag. 41
Chevrolet / Daewoo	da pag. 42 a pag. 46
Chrysler	da pag. 47 a pag. 50
Citroen	da pag. 51 a pag. 61
Dacia	da pag. 62 a pag. 62
Daihatsu	da pag. 63 a pag. 65
Fiat	da pag. 66 a pag. 98
Ford	da pag. 99 a pag. 117
Honda	da pag. 118 a pag. 127
Hyundai	da pag. 128 a pag. 138
Innocenti	da pag. 139 a pag. 139
Iveco / Om	da pag. 140 a pag. 147
Jeep	da pag. 148 a pag. 149
Kia	da pag. 150 a pag. 157
Lada	da pag. 158 a pag. 158
Lancia / Autobianchi	da pag. 159 a pag. 172
Land Rover	da pag. 173 a pag. 177
Mazda	da pag. 178 a pag. 183
MCC (Smart)	da pag. 184 a pag. 184
Mercedes	da pag. 185 a pag. 196
Mitsubishi	da pag. 197 a pag. 211
Nissan	da pag. 212 a pag. 227
Opel	da pag. 228 a pag. 240
Peugeot	da pag. 241 a pag. 254
Polski	da pag. 255 a pag. 255
Porsche	da pag. 256 a pag. 257
Renault	da pag. 258 a pag. 273
Rover Group	da pag. 274 a pag. 277
Saab	da pag. 278 a pag. 280
Seat	da pag. 281 a pag. 287
Skoda	da pag. 288 a pag. 291
Subaru	da pag. 292 a pag. 298
Suzuki	da pag. 299 a pag. 305

## Segue

Talbot/Simca	da pag.306 a pag.308
Toyota	da pag.309 a pag.326
Volkswagen	da pag.327 a pag.345
Volvo	da pag.346 a pag.354
Zastava	da pag.355 a pag.355

## Tubi flessibili per frizione

Tubi flessibili per frizione / Clutch hoses	da pag.359 a pag.364
---	----------------------

## Illustrazioni e componenti tubi freno





Illustrazioni e componenti tubi freno / Brake hoses illustrations	da pag.367 a pag.438
---	----------------------

## Lista numerica

Lista numerica tubi freno / Numerical list brake hoses	da pag.441 a pag.472
--	----------------------

## Tabella comparativa





Tabella comparativa / Cross list	da pag.475 a pag.490
----------------------------------	----------------------





 MALÒ	Costruttore/Car Manufacturers		Versione / Models		
80636	NISSAN	TRADE	2.3 D, 3.0 TDiC	<>	
80637	FORD	TRANSIT (2000->)	TT	>	
80638	NISSAN	TRADE	3.0 TDiC (Autobus)	<>	
80639	MAZDA	3	TT	<>	
	MAZDA	5	TT	<>	
80640	KIA	PICANTO	TT	<>	
80641	KIA	PICANTO	TT (- ABS)		<>
80642	KIA	PICANTO	TT (+ ABS)		>
80643	KIA	PICANTO	TT (+ ABS)		<
80644	FIAT	CROMA (Mod.2005)	1.9 JTD (150 CV)	<>	
	FIAT	CROMA (Mod.2005)	2.4 JTD	<>	
80645	TOYOTA	RAV 4 II (XA2)	TT	>	
80646	TOYOTA	RAV 4 II (XA2)	TT	<	
80647	TOYOTA	RAV 4 II (XA2)	TT		>
80648	TOYOTA	RAV 4 II (XA2)	TT		<
80649	TOYOTA	RAV 4 II (XA2)	TT (3 Porte)		<>
80650	TOYOTA	RAV 4 III	TT	>	
80651	TOYOTA	RAV 4 III	TT	<	
80652	TOYOTA	RAV 4 III	TT		>
80653	TOYOTA	RAV 4 III	TT		<
80654	AUDI	Q5	TT	<>	
80655	AUDI	A4 (Mod.2008)	TT		<>
	AUDI	A5	TT		<>
	AUDI	Q5	TT		<>
80656	BMW - MINI	X1 (E84)	TT	<>	
80657	BMW - MINI	X5 (E70)	TT	<>	
	BMW - MINI	X6 (E71)	TT	<>	
80658	BMW - MINI	X5 (E70)	TT		<>
	BMW - MINI	X6 (E71)	TT		<>
80659	CHEVROLET / DAEWOO	CAPTIVA	TT	<	
	OPEL	ANTARA	TT	<	
80660	CHEVROLET / DAEWOO	CAPTIVA	TT	>	
	OPEL	ANTARA	TT	>	
80661	CHEVROLET / DAEWOO	CAPTIVA	TT		>
	OPEL	ANTARA	TT		>
80662	CHEVROLET / DAEWOO	CAPTIVA	TT		<
	OPEL	ANTARA	TT		<
80663	CITROEN	C-Crosser	TT	<	
	MITSUBISHI	OUTLANDER II	TT	<	
	PEUGEOT	4007	TT	<	
80664	CITROEN	C-Crosser	TT	>	
	MITSUBISHI	OUTLANDER II	TT	>	
	PEUGEOT	4007	TT	>	
80665	CITROEN	C-Crosser	TT		<>
	MITSUBISHI	OUTLANDER II	TT		<>
	PEUGEOT	4007	TT		<>
80666	DACIA	DUSTER	TT	<>	
80667	HONDA	CRV III	TT	<	
80668	HONDA	CRV III	TT	>	
80669	HONDA	CRV III	TT		<>
80670	HYUNDAI	SANTA FE' II	TT	<	
	KIA	SORENTO III	TT	<	
80671	HYUNDAI	SANTA FE' II	TT	>	
	KIA	SORENTO III	TT	>	

# NUOVI PRODOTTI

elencati in ordine di riferimento Akron

Catalogo  
0113





 MALO	Costruttore/Car Manufacturers		Versione / Models		
80672	HYUNDAI	SANTA FE' II	TT		<
	KIA	SORENTO III	TT		<
80673	HYUNDAI	SANTA FE' II	TT		>
	KIA	SORENTO III	TT		>
80674	KIA	SORENTO II	TT	<	
80675	KIA	SORENTO II	TT	>	
80676	KIA	SORENTO I	TT		<
80677	KIA	SORENTO I	TT		>
80678	LANDROVER	FREELANDER I	TT	<>	
80680	LANDROVER	FREELANDER I	TT		<>
80681	MITSUBISHI	PAJERO III	TT	<>	
80682	MITSUBISHI	PAJERO III	TT		<>
80685	NISSAN	PATHFINDER (R51)	TT		<
80686	NISSAN	PATHFINDER (R51)	TT		>
80687	NISSAN	X-TRAIL II (T31)	TT	<	
	RENAULT	KOLEOS	TT	<	
80688	NISSAN	X-TRAIL II (T31)	TT	>	
	RENAULT	KOLEOS	TT	>	
80689	NISSAN	X-TRAIL II (T31)	TT		<
	RENAULT	KOLEOS	TT		<
80690	NISSAN	X-TRAIL II (T31)	TT		>
	RENAULT	KOLEOS	TT		>
80691	SUZUKI	GRAND VITARA (JT)	TT	<	
80692	SUZUKI	GRAND VITARA (JT)	TT	>	
80693	SUZUKI	GRAND VITARA (JT)	TT (alla pompa freno)		<
80694	SUZUKI	GRAND VITARA (JT)	TT		>
80695	SUZUKI	JIMNY	TT	<	
80696	SUZUKI	JIMNY	TT	>	
80697	LANDROVER	FREELANDER 2	TT	<>	
80698	LANDROVER	FREELANDER 2	TT		<>
80699	TOYOTA	LAND CRUISER (J12)	3.0 D-4D	<>	
80700	TOYOTA	LAND CRUISER (J12)	3.0 D-4D		<>
80701	TOYOTA	LAND CRUISER 150 (J15)	3.0 D-4D	<>	
80702	TOYOTA	LAND CRUISER 150 (J15)	3.0 D-4D		<
80703	TOYOTA	LAND CRUISER 150 (J15)	3.0 D-4D		>
80704	TOYOTA	LAND CRUISER (J20)	4.5 D V8, 4.8 V8	<	
80705	TOYOTA	LAND CRUISER (J20)	4.5 D V8, 4.8 V8	>	
80706	TOYOTA	LAND CRUISER (J20)	4.5 D V8, 4.8 V8		<>
80708	VOLVO	XC60	TT	<>	
80709	VOLVO	S60 II	TT		<
	VOLVO	S80 II	TT (Freno a mano elettronico)		<
	VOLVO	V60	TT		<
	VOLVO	V70 III	TT (Freno a mano elettronico)		<
	VOLVO	XC60	TT		<
	VOLVO	XC70 II	TT (Freno a mano elettronico)		<
80710	VOLVO	S60 II	TT		>
	VOLVO	V60	TT		>
	VOLVO	XC60	TT		>
80711	VOLVO	S80	TT (ruote 17")	<>	
	VOLVO	XC70 I	TT	<>	
80712	VOLVO	XC70 I	TT		<>
80713	VOLVO	S80 II	TT (Disco d.316/336)	<>	
	VOLVO	V70 III	TT (Disco d.316/336)	<>	
	VOLVO	XC70 II	TT (Disco d.316/336)	<>	





 MALÒ	Costruttore/Car Manufacturers		Versione / Models		
80715	VOLVO	S80 II	TT (Freno a mano elettronico)		>
	VOLVO	V70 III	TT (Freno a mano elettronico)		>
	VOLVO	XC70 II	TT (Freno a mano elettronico)		>
80716	VOLVO	XC90	TT	<>	
80717	VOLVO	XC90	TT		<>
80718	ALFA ROMEO	GIULIETTA (Mod.2010)	TT	<>	
	ALFA ROMEO	MITO	TT	<>	
80719	ALFA ROMEO	GIULIETTA (Mod.2010)	TT		<>
80720	FIAT	500L (09/2012->)	TT	<>	
	FIAT	PUNTO Evo	TT	<>	
	FIAT	Punto MY2012	TT	<>	
80721	AUDI	A4 (Mod.2008)	TT	<>	
	AUDI	A5	TT	<>	
80722	AUDI	TT (Mod 2007)	TT (Mod. 1LL,1LJ)	<>	
80723	AUDI	TT (Mod 2007)	TT (Mod. 1LK,1LM,1LN)	<>	
80724	AUDI	TT (Mod 2007)	TT - TT	<>	
80725	BMW - MINI	MINI (R56-R57)	TT	<>	
	BMW - MINI	MINI Clubman (R55)	TT	<>	
80726	BMW - MINI	Z4	TT sdrive (all pinza)		<>
80727	BMW - MINI	Z4	TT		<
80728	BMW - MINI	Z4	TT		>
80729	BMW - MINI	Z4	TT (all pinza)		<>
80730	CHEVROLET / DAEWOO	SPARK	TT	<>	
80731	CHEVROLET / DAEWOO	SPARK	TT		<>
80733	CHEVROLET / DAEWOO	CRUZE	TT		<
80734	CHEVROLET / DAEWOO	CRUZE	TT		>
80735	CHRYSLER	VOYAGER IV	TT	<	
80736	CHRYSLER	VOYAGER IV	TT	>	
80737	CHRYSLER	VOYAGER IV	TT		<
80738	CHRYSLER	VOYAGER IV	TT		>
80741	CITROEN	C3 (Mod.2009) - DS3	TT	<>	
	PEUGEOT	208	TT	<>	
80744	CITROEN	C3 (Mod.2009) - DS3	TT		<>
80745	CITROEN	NEMO	TT	<>	
	PEUGEOT	BIPPER	TT	<>	
80746	RENAULT	KANGOO (Mod.2008)	TT	<>	
80747	RENAULT	SPACE III	TT (centrale)		○
	RENAULT	KANGOO (Mod.2008)	TT		<>
	RENAULT	MEGANE II	TT		<>
	RENAULT	TWINGO	TT (- ABS)		<>
80748	CITROEN COMM	JUMPY (Mod. 2007)	TT	<>	
	PEUGEOT	EXPERT (Mod. 2007)	TT	<>	
80749	CITROEN COMM	JUMPY (Mod. 2007)	TT		<>
	PEUGEOT	EXPERT (Mod. 2007)	TT		<>
80750	FORD	C-MAX II	TT (Disco)		<>
	FORD	FOCUS II (Restyling 2008->)	TT (Disco)		<>
80751	FORD	FIESTA VI (10/08-)	TT	<>	
80752	FORD	FIESTA VI (10/08-)	TT (Interno)		<>
80755	FORD	KA (Mod.2009)	TT	<>	
80758	FORD	KA (Mod.2009)	TT		<>
80760	FORD	GALAXY (MOD. 2006)	TT		<>
	FORD	MONDEO IV (03/07-)	TT		<>
	FORD	S-MAX	TT		<>

# NUOVI PRODOTTI

elencati in ordine di riferimento Akron

Catalogo  
0113

 MALO	Costruttore/Car Manufacturers		Versione / Models		
80761	FORD	KUGA	TT		<>
80762	HONDA	ACCORD IX	TT	<	
80763	HONDA	ACCORD IX	TT	>	
80764	HONDA	ACCORD IX	TT		<
80765	HONDA	ACCORD IX	TT		>
80766	HONDA	FRV	TT	<	
80767	HONDA	FRV	TT	>	
80768	HONDA	FRV	TT		<
80769	HONDA	FRV	TT		>
80770	HYUNDAI	ACCENT III	TT	<	
80771	HYUNDAI	ACCENT III	TT	>	
80772	HYUNDAI	ACCENT III	TT		<
	KIA	RIO II	TT		<
80773	HYUNDAI	ACCENT III	TT		>
	KIA	RIO II	TT		>
80774	HYUNDAI	H1 (Mod.2008)	TT	<	
80775	HYUNDAI	H1 (Mod.2008)	TT	>	
80776	HYUNDAI	H1 (Mod.2008)	TT		<
80777	HYUNDAI	H1 (Mod.2008)	TT		>
80778	KIA	CARENS III	TT	<	
80779	KIA	CARENS III	TT	>	
80780	KIA	CARENS III	TT		<
80781	KIA	CARENS III	TT		>
80782	KIA	CEE'D - PRO CEE'D	TT	<	
80783	KIA	CEE'D - PRO CEE'D	TT	>	
80784	KIA	CEE'D - PRO CEE'D	TT		<
80785	KIA	CEE'D - PRO CEE'D	TT		>
80786	KIA	RIO	TT	<>	
80787	KIA	RIO	TT		<>
80788	KIA	RIO II	TT	<	
80789	KIA	RIO II	TT	>	
80790	KIA	SOUL	TT	>	
80791	KIA	SOUL	TT	<	
80792	KIA	SOUL	TT		<
80793	KIA	SOUL	TT		>
80794	KIA	VENGA	TT	<	
80795	KIA	VENGA	TT	>	
80796	HYUNDAI	IX20	TT		<
	KIA	VENGA	TT		<
80797	HYUNDAI	IX20	TT		>
	KIA	VENGA	TT		>
80799	MAZDA	2	TT	<	
80800	MAZDA	2	TT	>	
80801	MAZDA	2	TT		<>
80802	MAZDA	5	TT		<>
80803	MAZDA	6 (Mod.2007)	TT	<	
80804	MAZDA	6 (Mod.2007)	TT	>	
80805	MAZDA	6 (Mod.2007)	TT		<>
80806	MERCEDES	CLASSE C (W204)	TT		<>
	MERCEDES	CLASSE GLK (X204)	TT		<>
80807	MERCEDES	CLASSE E (W212)	TT	<>	
80808	MERCEDES	CLASSE E (W212)	TT		<>
80809	MERCEDES	CLASSE GLK (X204)	TT	<>	
80811	MITSUBISHI	COLT VI	TT (freno a tamburo)		<>





 MALÒ	Costruttore/Car Manufacturers		Versione / Models		
80811	MITSUBISHI	COLT VII	TT (freno a tamburo)		<>
	MITSUBISHI	COLT CZC	TT (freno a tamburo)		<>
80812	MITSUBISHI	ASX	TT	<	
	MITSUBISHI	LANCER VIII	TT	<	
80813	MITSUBISHI	ASX	TT	>	
	MITSUBISHI	LANCER VIII	TT	>	
80814	MITSUBISHI	ASX	TT		<>
	MITSUBISHI	LANCER VIII	TT		<>
80815	NISSAN	CUBE (Z12)	TT	<	
80816	NISSAN	CUBE (Z12)	TT	>	
80817	NISSAN	CUBE (Z12)	TT		<
80818	NISSAN	CUBE (Z12)	TT		>
80819	NISSAN	QASHQAI	TT	<	
80820	NISSAN	QASHQAI	TT	>	
80821	NISSAN	QASHQAI	TT		<
80822	NISSAN	QASHQAI	TT		>
80823	NISSAN	PIXO (UA0)	TT	<	
80824	NISSAN	PIXO (UA0)	TT	>	
80825	NISSAN	PIXO (UA0)	TT		<>
80826	OPEL	AGILA (Mod. 2007)	TT	<>	
80827	OPEL	AGILA (Mod. 2007)	TT		<
80828	OPEL	AGILA (Mod. 2007)	TT		>
80829	OPEL	INSIGNIA	TT (Ruote 16")	<>	
80830	OPEL	INSIGNIA	TT (Ruote 18")	<>	
80831	OPEL	INSIGNIA	TT		<>
80832	OPEL	ASTRA J	TT	<>	
80833	OPEL	ASTRA J	TT		<
80834	OPEL	ASTRA J	TT		>
80835	PEUGEOT	308	TT	<>	
	PEUGEOT	3008	TT	<>	
	PEUGEOT	5008	TT	<>	
80838	PEUGEOT	5008	TT		<
80839	PEUGEOT	5008	TT		>
80840	PEUGEOT	607	TT	<>	
80841	PEUGEOT	607	TT		<>
80842	CITROEN	NEMO	TT		<>
	PEUGEOT	BIPPER	TT		<>
80843	RENAULT	LAGUNA III	TT	<>	
80846	RENAULT	MEGANE III	TT	<>	
	RENAULT	SCENIC III	TT	<>	
80849	SAAB	9-3 Sport (Mod.2007)	TT		<
80850	SAAB	9-3 Sport (Mod.2007)	TT		>
80851	SEAT	IBIZA V (6J5)	TT	<>	
	VW	Polo V (6R) (06/09->)	TT	<>	
80852	SEAT	LEON II (1P1)	TT		<>
	SKODA	OCTAVIA II (1Z3-1Z5)	TT		<>
	SKODA	SUPERB II (3T4)	TT		<>
	SKODA	YETI	TT		<>
	VW	EOS	TT		<>
	VW	GOLF VI	TT		<>
	VW	JETTA III	TT		<
	VW	SCIROCCO (137)	TT		<
VW	TOURAN	TT		<>	
80854	MCC (SMART)	Fortwo Coupé (Mod.2007)	TT	<>	





# NUOVI PRODOTTI

elencati in ordine di riferimento Akron

Catalogo  
0113





 MALÒ	Costruttore/Car Manufacturers		Versione / Models		
80855	MCC (SMART)	Fortwo Coupé (Mod.2007)	TT		<>
80856	SUBARU	IMPREZA (GR)	TT		<
80857	SUBARU	IMPREZA (GR)	TT		>
80858	SUBARU	LEGACY V	TT	<	
80859	SUBARU	LEGACY V	TT	>	
80860	SUBARU	LEGACY V	TT		<
80861	SUBARU	LEGACY V	TT		>
80862	SUBARU	JUSTY IV	TT	<	
80863	SUBARU	JUSTY IV	TT	>	
80864	SUBARU	JUSTY IV	TT		<>
80865	SUBARU	FORESTER (SH)	TT	<	
80866	SUBARU	FORESTER (SH)	TT	>	
80867	SUBARU	FORESTER (SH)	TT		<
80868	SUBARU	FORESTER (SH)	TT		>
80869	SUBARU	TRIBECA	TT	<	
80870	SUBARU	TRIBECA	TT	>	
80871	SUBARU	TRIBECA	TT		<
80872	SUBARU	TRIBECA	TT		>
80874	SUZUKI	ALTO V (GF)	TT	<	
80875	SUZUKI	ALTO V (GF)	TT	>	
80876	SUZUKI	ALTO V (GF)	TT		<>
80878	TOYOTA	AURIS	TT	<	
80879	TOYOTA	AURIS	TT	>	
80880	TOYOTA	AURIS	TT		<>
	TOYOTA	VERSO	TT		<>
80881	TOYOTA	VERSO	TT	<	
80882	TOYOTA	VERSO	TT	>	
80883	TOYOTA	AVENSIS (T27)	TT	<	
80884	TOYOTA	AVENSIS (T27)	TT	>	
80885	TOYOTA	AVENSIS (T27)	TT		<>
80886	TOYOTA	PRIUS (Mod.2009)	TT	<	
80887	TOYOTA	PRIUS (Mod.2009)	TT	>	
80888	TOYOTA	PRIUS (Mod.2009)	TT		
80889	TOYOTA	URBAN CRUISER	TT	<	
	TOYOTA	VERSO S	TT	<	
	TOYOTA	YARIS II	TT	<	
80890	TOYOTA	URBAN CRUISER	TT	>	
	TOYOTA	VERSO S	TT	>	
	TOYOTA	YARIS II	TT	>	
80891	TOYOTA	URBAN CRUISER	TT		<>
	TOYOTA	VERSO S	TT		<>
	TOYOTA	YARIS II	TT		<>
80892	SKODA	YETI	TT		<>
	VW	EOS	TT		<>
	VW	SCIROCCO (137)	TT		<>
80893	VW	TIGUAN	TT	<>	
80894	VW	PASSAT (362, 365)	TT		<>
	VW	SHARAN (Mod. 2010)	TT		<>
	VW	TIGUAN	TT		<>
80895	VW	MULTIVAN	TT	<>	
	VW	TRANSPORTER T5	TT	<>	
80896	VW	MULTIVAN	TT (intermedio)		<>
	VW	TRANSPORTER T5	TT (intermedio)		<>
80897	VOLVO	C30	TT (ruote 15"-16")	<>	





MALÒ	Costruttore/Car Manufacturers		Versione / Models		
80897	VOLVO	S40 II	TT (ruote 15"-16")	<>	
	VOLVO	V50	TT (ruote 15"-16")	<>	
80898	VOLVO	C30	TT		<>
	VOLVO	S40 II	TT		<>
	VOLVO	V50	TT		<>
80899	VOLVO	S60 II	TT	<>	
	VOLVO	S80 II	TT (Disco d.300)	<>	
	VOLVO	V60	TT	<>	
	VOLVO	V70 III	TT (Disco d.300)	<>	
	VOLVO	XC70 II	TT (Disco d.300)	<>	
80900	MAZDA	CX7	TT	<>	
80901	MAZDA	CX7	TT		<>
80902	HYUNDAI	I10	TT	<>	
80903	HYUNDAI	I10	TT		<
80904	HYUNDAI	I10	TT		>
80905	HYUNDAI	I20	TT	<	
80906	HYUNDAI	I20	TT	>	
80907	HYUNDAI	I20	TT		<
80908	HYUNDAI	I20	TT		>
80909	HYUNDAI	I30	TT	<	
80910	HYUNDAI	I30	TT	>	
80911	HYUNDAI	I30	TT		<
80912	HYUNDAI	I30	TT		>
80913	HYUNDAI	IX35	TT	<	
	KIA	SPORTAGE III	TT	<	
80914	HYUNDAI	IX35	TT	>	
	KIA	SPORTAGE III	TT	>	
80915	HYUNDAI	IX35	TT		<
	KIA	SPORTAGE III	TT		<
80916	HYUNDAI	IX35	TT		>
	KIA	SPORTAGE III	TT		>
80917	KIA	SORENTO I	TT	<	
80918	KIA	SORENTO I	TT	>	
80919	KIA	SORENTO II	TT		<>
80920	CHRYSLER	VOYAGER III	TT	<	
80921	CHRYSLER	VOYAGER III	TT	>	
80922	CHRYSLER	VOYAGER III	TT		<
80923	CHRYSLER	VOYAGER III	TT		>
80924	MITSUBISHI	LANCER VII	1.3, 1.6, 2.0	<>	
	MITSUBISHI	OUTLANDER I	TT	<>	
80925	MITSUBISHI	LANCER VII	1.3, 1.6, 2.0		<>
	MITSUBISHI	OUTLANDER I	TT		<>
80926	NISSAN	NAVARA (D40)	TT		<>
80927	NISSAN	X-TRAIL I (T30)	TT	<	
80928	NISSAN	X-TRAIL I (T30)	TT	>	
80929	NISSAN	X-TRAIL I (T30)	TT		<
80930	NISSAN	X-TRAIL I (T30)	TT		>
80931	NISSAN	JUKE	TT	<	
80932	NISSAN	JUKE	TT	>	
80933	NISSAN	JUKE	TT		<
80934	NISSAN	JUKE	TT		>
80935	NISSAN	MICRA (K13)	TT	<	
80936	NISSAN	MICRA (K13)	TT	>	
80937	NISSAN	MICRA (K13)	TT		<>

# NUOVI PRODOTTI

elencati in ordine di riferimento Akron

Catalogo  
0113





 MALO	Costruttore/Car Manufacturers		Versione / Models		
80938	RENAULT	MEGANE III	TT		<>
	RENAULT	SCENIC III	TT		<>
80939	SUZUKI	JIMNY	TT		<>
80940	TOYOTA	YARIS II (Made in France)	TT	<	
80941	TOYOTA	YARIS II (Made in France)	TT	>	
80942	TOYOTA	YARIS II (Made in France)	TT		<
80943	TOYOTA	YARIS II (Made in France)	TT		>
80944	TOYOTA	YARIS II (Made in France)	TT (freno a disco)		<>
80946	VOLVO	S80 II	TT		<>
	VOLVO	V70 III	TT		<>
	VOLVO	XC70 II	TT		<>
80947	VOLVO	C30	TT (ruote 17")	<>	
	VOLVO	S40 II	TT (ruote 17")	<>	
	VOLVO	V50	TT (ruote 17")	<>	
80948	AUDI	A1	TT	<>	
	SEAT	IBIZA V (6J5)	TT	<>	
	VW	Polo V (6R) (06/09->)	TT	<>	
80949	BMW - MINI	7 (E65,E66)	TT	<>	
80950	BMW - MINI	X3 (F25)	TT	<>	
80951	BMW - MINI	X3 (F25)	TT		<>
80952	CITROEN	C5 (Mod.2008)	TT	>	
	PEUGEOT	407	TT (+ ESP)	>	
80953	CITROEN	C5 (Mod.2008)	TT	<	
	PEUGEOT	407	TT (+ ESP)	<	
80954	DAIHATSU	CUORE (Mod. 2003)	1.0	<>	
	DAIHATSU	TREVIS	1.0	<>	
80955	DAIHATSU	CUORE (Mod. 2003)	1.0		<>
	DAIHATSU	TREVIS	1.0		<>
80956	DAIHATSU	CUORE (Mod. 2007)	1.0	>	
80957	DAIHATSU	CUORE (Mod. 2007)	1.0	<	
80958	DAIHATSU	CUORE (Mod. 2007)	1.0		<>
80959	DAIHATSU	TERIOS II	TT	>	
80960	DAIHATSU	TERIOS II	TT	<	
80961	DAIHATSU	TERIOS II	TT		>
80962	DAIHATSU	TERIOS II	TT		<
80963	FIAT	DOBLO' (Mod.2010)	TT	<>	
80964	FIAT	DOBLO' (Mod.2010)	TT		<>
80965	FORD	TRANSIT (2006->)	TT	<>	
80966	FORD	TRANSIT (2006->)	TT		<>
80967	FORD	TRANSIT (2006->)	TT (Ruote gemellate)		<>
80968	HONDA	CIVIC VI	TT	<	
80969	HONDA	CIVIC VI	TT	>	
80970	HONDA	CIVIC VI	TT		<
80971	HONDA	CIVIC VI	TT		>
80972	HONDA	CIVIC VII	TT	<	
80973	HONDA	CIVIC VII	TT	>	
80974	HONDA	CIVIC VII	TT		<
80975	HONDA	CIVIC VII	TT		>
80976	HONDA	JAZZ (Mod. 2002)	TT	<	
80977	HONDA	JAZZ (Mod. 2002)	TT	>	
80978	HONDA	JAZZ (Mod. 2002)	TT		<
80979	HONDA	JAZZ (Mod. 2002)	TT		>
80980	HONDA	JAZZ (Mod. 2008)	TT	<	
80981	HONDA	JAZZ (Mod. 2008)	TT	>	

 MALÒ	Costruttore/Car Manufacturers		Versione / Models		
80982	KIA	CERATO	TT	<	
80983	KIA	CERATO	TT	>	
80984	KIA	CERATO	TT		<>
80985	FIAT	YPSILON (MOD. 2011)	TT		<>
80986	LANDROVER	DISCOVERY II	2.5 TDI, 4.0	<	
80987	LANDROVER	DISCOVERY II	2.5 TDI, 4.0	>	
80988	LANDROVER	DISCOVERY II	2.5 TDI, 4.0		<
80989	LANDROVER	DISCOVERY II	2.5 TDI, 4.0		>
80990	LANDROVER	DISCOVERY III	2.7 TDV6, 4.4	<	
80991	LANDROVER	DISCOVERY III	2.7 TDV6, 4.4	>	
80992	LANDROVER	DISCOVERY III	2.7 TDV6, 4.4		<>
	LANDROVER	DISCOVERY IV	TT		<>
80993	LANDROVER	RANGE ROVER II	TT		<>
80994	LANDROVER	RANGE ROVER III	TT	<>	
80995	LANDROVER	RANGE ROVER SPORT	TT	<	
80996	LANDROVER	RANGE ROVER SPORT	TT	>	
80997	LANDROVER	RANGE ROVER SPORT	TT		<>
80998	MERCEDES	CLASSE M (W164)	TT	<>	
80999	MERCEDES	CLASSE M (W164)	TT		<>
81000	MERCEDES	CLASSE S (W221)	TT	<>	
81001	MERCEDES	CLASSE S (W221)	TT		<>
81002	PEUGEOT	508	TT	>	
81003	PEUGEOT	508	TT	<	
81004	RENAULT comm	MASTER IV	TT	<>	
81005	RENAULT comm	MASTER IV	TT		<>
81006	TOYOTA	AVENSIS VERSO	TT	<>	
81007	TOYOTA	IQ	TT	<	
81008	TOYOTA	IQ	TT	>	
81009	TOYOTA	IQ	TT		<
81010	TOYOTA	IQ	TT		>
81011	VW	PASSAT (362, 365)	TT	<>	
81012	AUDI	A8 (Mod 2002)	TT	<>	
	VW	PHAETON	TT	<>	
81013	VW	PHAETON	TT		<>
81014	VW	SHARAN (Mod. 2010)	TT	<>	
81015	FIAT	FREEMONT	TT	>	
81016	FIAT	FREEMONT	TT	<	
81017	FIAT	FREEMONT	TT (centrale)		○
81018	FIAT	FREEMONT	TT		>
81019	FIAT	FREEMONT	TT		<
81020	AUDI	A3 (Mod. 2003)	TT (PR: 1LK)	<>	
	SEAT	ALTEA		<>	
	SEAT	ALTEA		<>	
	SEAT	LEON II (1P1)		<>	
	SEAT	TOLEDO II		<>	
	SKODA	OCTAVIA II (1Z3-1Z5)		<>	
	SKODA	SUPERB II (3T4)		<>	
	SKODA	YETI		<>	
	VW	EOS		<>	
	VW	GOLF V	TT	<>	
	VW	GOLF V PLUS	TT	<>	
	VW	GOLF VI	TT	<>	
	VW	JETTA III		<>	
	VW	SCIROCCO (137)		<>	

# NUOVI PRODOTTI

elencati in ordine di riferimento Akron

Catalogo  
0113

 MALÒ	Costruttore/Car Manufacturers		Versione / Models		
81020	VW	TOURAN		<>	
	VW	CADDY III		<>	
81022	VW	MULTIVAN	TT		<>
	VW	TRANSPORTER T5	TT		<>
81023	AUDI	A6 (Mod.2011)	TT	<>	
	AUDI	A7	TT	<>	
81024	AUDI	A6 (Mod.2011)	TT		<>
	AUDI	A7	TT		<>
81025	AUDI	Q3	TT	<>	
81026	AUDI	Q3	TT		<>
81027	BMW - MINI	Serie 3 (F30)	TT	<>	
81028	BMW - MINI	Serie 5 Granturismo (F07)	TT	<>	
	BMW - MINI	Serie 5 (F10)	TT	<>	
81029	BMW - MINI	Serie 5 Granturismo (F07)	TT		<>
	BMW - MINI	Serie 5 (F10)	TT		<>
81030	BMW - MINI	MINI Countryman (R60)	TT	<>	
81031	BMW - MINI	MINI Countryman (R60)	TT		<>
81032	CITROEN	C4 (Mod. 2009) - DS4	TT	<>	
81033	FIAT	500L (09/2012->)	TT		<>
81035	FIAT Commercial	Ducato MY2011	TT (carreggiata maggiorata)		<>
81036	FORD	C-MAX III (Mod 2010)	TT	<>	
	FORD	Focus III (Mod 2011)	TT	<>	
81037	FORD	C-MAX III (Mod 2010)	TT		<>
	FORD	Focus III (Mod 2011)	TT (Berlina)		<>
81038	FORD	Focus III (Mod 2011)	TT (SW)		<>
81039	HYUNDAI	I40	TT	<	
81040	HYUNDAI	I40	TT	>	
81041	HYUNDAI	I40	TT		<
81042	HYUNDAI	I40	TT		>
81043	HYUNDAI	IX20	TT	<	
81044	HYUNDAI	IX20	TT	>	
81045	JEEP	CHEROKEE (KJ)	TT	<	
81046	JEEP	CHEROKEE (KJ)	TT	>	
81047	JEEP	CHEROKEE (KK)	TT	<	
81048	JEEP	CHEROKEE (KK)	TT	>	
81049	KIA	RIO III	TT	<	
81050	KIA	RIO III	TT	>	
81051	KIA	RIO III	TT		<>
81052	LANDROVER	DISCOVERY IV	TT	<	
81053	LANDROVER	DISCOVERY IV	TT	>	
81054	MERCEDES	CLASSE B (W246)	TT	<>	
81055	MERCEDES	CLASSE B (W246)	TT		<>
81056	MITSUBISHI	COLT VII	TT (Tamburo Post.)		<>
81057	MITSUBISHI	COLT VII	TT (Disco Post.)		<>
81058	SEAT	Mii	TT	<>	
	VW	UP	TT	<>	
81059	SEAT	Mii	TT		<>
	VW	UP	TT		<>
81060	TOYOTA	YARIS III	TT	<	
81061	TOYOTA	YARIS III	TT	>	
81062	TOYOTA	YARIS III	TT		<
81063	TOYOTA	YARIS III	TT		>
81064	VW	Amarok	TT	<>	
81065	VW	Amarok	TT		<>







# Tubi flessibili per Freno e Frizione

Catalogo

01  
13

Tubi flessibili per freno









**TUBI FLESSIBILI PER FRENO**

**L**

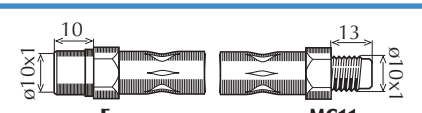
**o.e.**
**33**
**-1989**

TT (- Super)	-89	<b>8421</b>	<>		450	 <b>MC11</b> <b>MC22</b>	60536813
Super	-89	<b>8420</b>	<>		450	 <b>MC11</b> <b>MC22</b>	60537428
TT	-89	<b>8370</b>		<>	365	 <b>F</b> <b>MC11</b>	60536905

**1990-12/93**

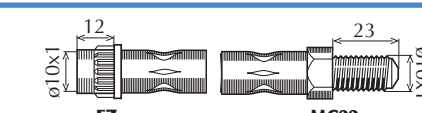
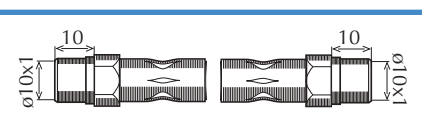
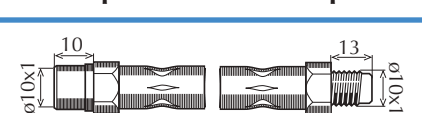
TT Resty. (- TD)	90-12/93	<b>8419</b>	<>		480	 <b>MC11</b> <b>MC22</b>	60559895
TD Resty.	90-12/93	<b>8421</b>	<>		450	 <b>MC11</b> <b>MC22</b>	60501727
TT Resty.	90-12/93	<b>8422</b>		>	357	 <b>FZ</b> <b>MC22</b>	60501724
TT Resty.	90-12/93	<b>8423</b>		<	342	 <b>F</b> <b>F</b>	60501717
TT Resty. (+ ABS)	90-12/93	<b>8566</b>		<>	400	 <b>F</b> <b>MC11</b>	60562631

**4x4**

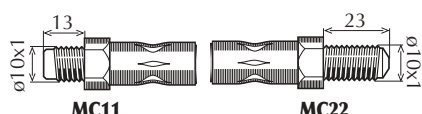
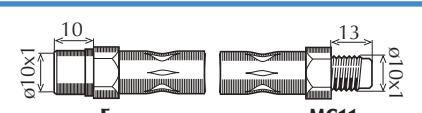
4x4		<b>8420</b>	<>		450	 <b>MC11</b> <b>MC22</b>	60537428
4x4		<b>8234</b>		<>	326	 <b>F</b> <b>MC11</b>	60747207

## TUBI FLESSIBILI PER FRENO



L



o.e.

### 75

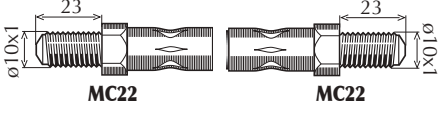
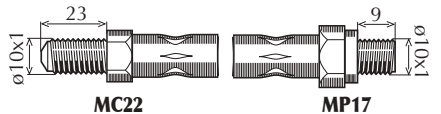
TT	05/85-02/92	8376	<>		445		60522545
TT	05/85-02/92	8377	<>		273		60522547

### 90

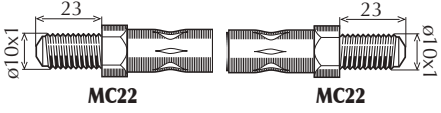
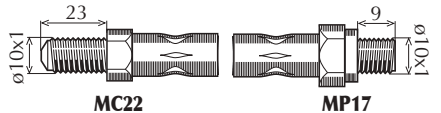

TT	10/84-07/87	8376	<>		445		60522545
TT	10/84-07/87	8377	<>		273		60522547

### 145

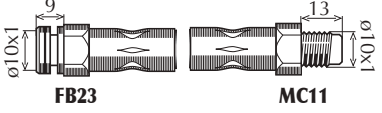
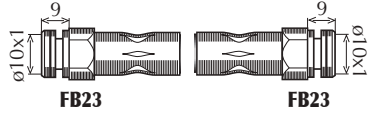
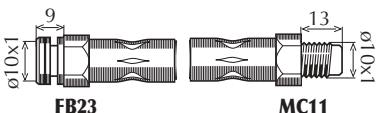
#### 09/94-12/96

TT	9/94-12/96	8436	<>		435		60540018
TT (intermedio)	9/94-12/96	8417		○	240		7667806
TT	9/94-12/96	8459	<>		182		60800372

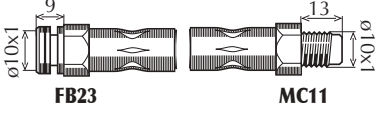
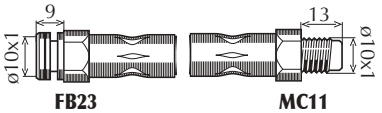

#### 01/97-01/01

1.4 TS (s/ABS)	01/97-01/01	8553	<>		435		46448592
1.6 TS, 1.8 TS (s/ABS)	01/97-01/01	8552	<>		415		60812250
1.9 TD (s/ABS)	01/97-01/01	8436	<>		435		60540018

Legenda/Legend: ○ = Intermedio/Intermediate - ● = Interno/Inner - ▲ = Superiore/Upper - ▼ = Inferiore/Lower

**TUBI FLESSIBILI PER FRENO**

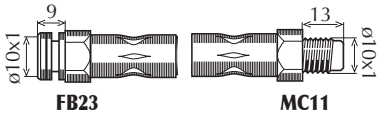
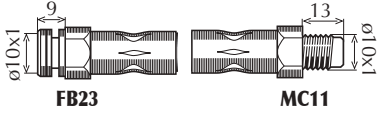
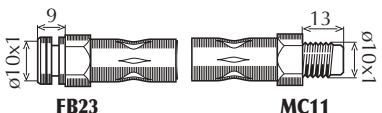

**o.e.**
**segue 145**
**segue 01/97-01/01**

1.4 TS, 1.6 TS, 1.8 TS, 1.9 TD, JTD (c/ABS)	01/97-01/01	<b>8552</b>	<>		415	 <b>FB23</b> <b>MC11</b>	60812250
2.0 TS (c/ABS)	01/97-01/01	<b>8553</b>	<>		435	 <b>FB23</b> <b>MC11</b>	46448592
TT (intermedio)	01/97-01/01	<b>8417</b>		○	240	 <b>FB23</b> <b>MC11</b>	7667806
TT	01/97-01/01	<b>8459</b>	<>		182	 <b>FB23</b> <b>MC11</b>	60800372

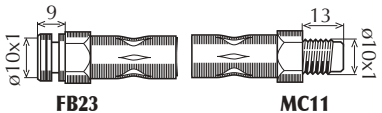
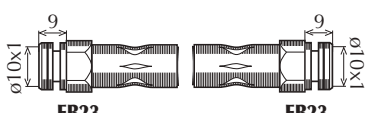
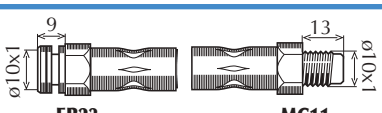
**146**
**12/94-12/96**

TT	12/94-12/96	<b>8436</b>	<>		435	 <b>FB23</b> <b>MC11</b>	60540018
TT (intermedio)	12/94-12/96	<b>8417</b>		○	240	 <b>FB23</b> <b>FB23</b>	7667806
TT	12/94-12/96	<b>8459</b>	<>		182	 <b>FB23</b> <b>MC11</b>	60800372

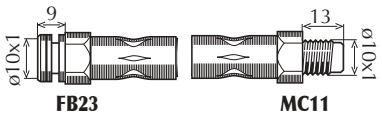
**01/97-01/01**

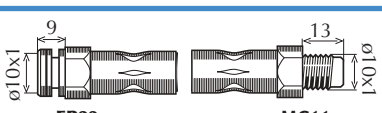
1.4 TS (s/ABS)	01/97-01/01	<b>8553</b>	<>		435	 <b>FB23</b> <b>MC11</b>	46448592
1.6 TS, 1.8 TS (s/ABS)	01/97-01/01	<b>8552</b>	<>		415	 <b>FB23</b> <b>MC11</b>	60812250
1.9 TD (s/ABS)	01/97-01/01	<b>8436</b>	<>		435	 <b>FB23</b> <b>MC11</b>	60540018

## TUBI FLESSIBILI PER FRENO



o.e.

### segue 146

#### segue 01/97-01/01

1.4 TS, 1.6 TS, 1.8 TS, 1.9 TD, JTD (c/ABS)	01/97-01/01	8552	<>		415	 <b>FB23</b> <b>MC11</b>	60812250
2.0 TS (c/ABS)	01/97-01/01	8553	<>		435	 <b>FB23</b> <b>MC11</b>	46448592
TT (intermedio)	01/97-01/01	8417		○	240	 <b>FB23</b> <b>FB23</b>	7667806
TT	01/97-01/01	8459	<>		182	 <b>FB23</b> <b>MC11</b>	60800372

### 147

TT	01/01-	8567	<>		420	 <b>FB23</b> <b>MC11</b>	46474539
TT	01/01-	8568	<>		435	 <b>FB23</b> <b>MC11</b>	46454474

### 155

TT	11/91-12/97	8436	<>		435	 <b>FB23</b> <b>MC11</b>	60540018
TT/BZ (- ABS)	11/91-94	8489	<>		210	 <b>FB23</b> <b>MC11</b>	60808815
TT/BZ (+ ABS)	11/91-94	8459	<>		182	 <b>FB23</b> <b>MC11</b>	60800372
TT/BZ	95-12/97	8459	<>		182	 <b>FB23</b> <b>MC11</b>	60800372
TT/DS	11/91-12/97	8489	<>		210	 <b>FB23</b> <b>MC11</b>	60808815

Legenda/Legend: ○ = Intermedio/Intermediate - ● = Interno/Inner - ▲ = Superiore/Upper - ▼ = Inferiore/Lower

**TUBI FLESSIBILI PER FRENO**

**L**

**o.e.**
**156**

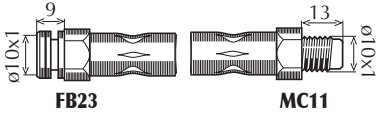
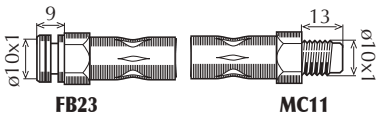
TT	10/97-	<b>8567</b>	<>		420		46474539
TT	10/97-	<b>8568</b>	<>		435		46454474

**159**

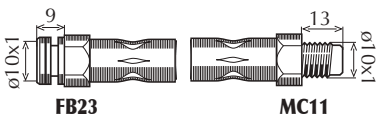
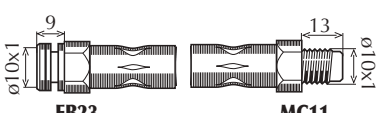
TT	09/05-	<b>80185</b>	<>		524		60698794
TT	09/05-	<b>80189</b>	<>		425		60698796

**164**

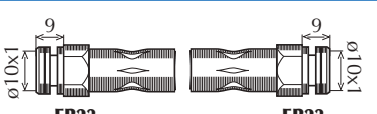
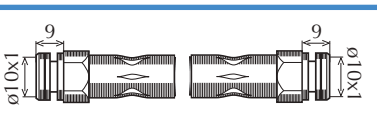
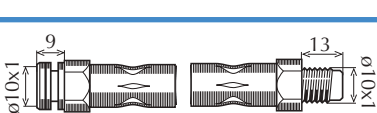
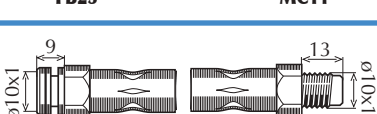
2.0, 3.0, 2.5 TD	06/87-09/98	<b>8434</b>	<>		380		60546644
V6 Turbo	03/91-09/98	<b>8493</b>	<>		335		60588022
2.0,3.0,2.5 TD( - ABS)	06/87-09/98	<b>8435</b>	<>		428		60546646
V6 Turbo, TT (ABS)	06/87-09/98	<b>8492</b>	<>		430		60511713

**166**

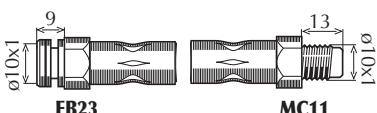
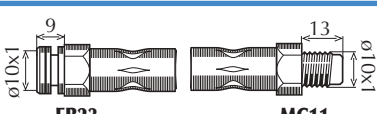
2.0, 2.5 V6, 2.4 JTD	09/98-	<b>8900</b>	<>		575		60651554
3.0 V	09/98-	<b>8901</b>	<>		595		60651553

## TUBI FLESSIBILI PER FRENO



L



o.e.

### segue 166

TT	09/98-	8902	<>	450	<p>FB23 MC11</p>	60651567
----	--------	------	----	-----	------------------	----------

### 2000

TT	01/70-79	8024	<>	390	<p>MC4 MC4</p>	60714552
TT	01/70-79	8025	<>	380	<p>MC4 MP4</p>	60714553

### ALFASUD

TT	71-86	8289	<>	310	<p>F MC11</p>	60709427
TT	71-86	8290	<>	389	<p>F MC11</p>	60709428

### ALFETTA

TT	77-04/83	8283	<>	370	<p>MC22 MC22</p>	60727319
TT	05/83-86	8376	<>	445	<p>MC22 MC22</p>	60522545
TT	77-04/83	8284	<>	387	<p>MC22 MP17</p>	60724772
TT	05/83-86	8377	<>	273	<p>MC22 MP17</p>	60522547

### ARNA

TT	83-86	8421	<>	450	<p>MC11 MC22</p>	60536813
----	-------	------	----	-----	------------------	----------

## TUBI FLESSIBILI PER FRENO



L



o.e.

### segue ARNA

TT	83-86	<b>8370</b>	<>	365	 <p>F MC11</p>	60536905
----	-------	-------------	----	-----	--	----------



### BRERA

2.2, 3.2	01/06-	<b>80189</b>	<>	425	 <p>FB23 MC11</p>	60698796
----------	--------	--------------	----	-----	---	----------

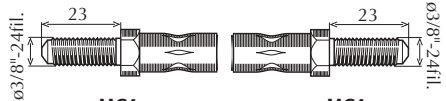
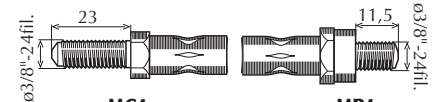

### GIULIA

TT	01/70-79	<b>8024</b>	<>	390	 <p>MC4 MC4</p>	60714552
TT	01/70-79	<b>8025</b>	<>	380	 <p>MC4 MP4</p>	60714553

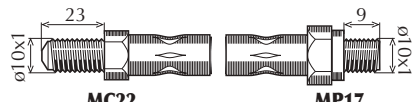
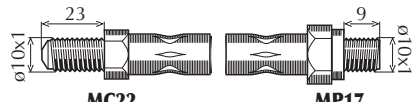
### GIULIETTA

TT	77-04/83	<b>8283</b>	<>	370	 <p>MC22 MC22</p>	60727319
TT	05/83-86	<b>8376</b>	<>	445	 <p>MC22 MC22</p>	60522545
TT	77-04/83	<b>8284</b>	<>	387	 <p>MC22 MP17</p>	60724772
TT	05/83-86	<b>8377</b>	<>	273	 <p>MC22 MP17</p>	60522547

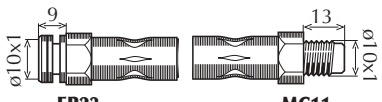
### GIULIETTA (Mod.2010)

TT	04/10-	<b>80718</b>	<>	430	 <p>FB23 MC11</p>	51811926
TT	04/10-	<b>80719</b>	<>	455	 <p>FB23 MC11</p>	50518954



## TUBI FLESSIBILI PER FRENO



**o.e.**

### GTV (- 01/81)

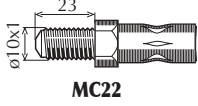
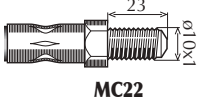
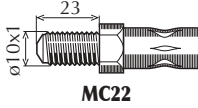
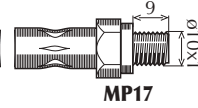
TT	-01/81	<b>8283</b>	<>		370	 MC22	 MC22	60727319
TT	-01/81	<b>8284</b>	<>		387	 MC22	 MP17	60724772

### GTV (02/81 -)

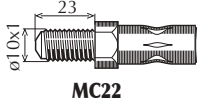
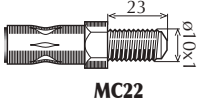
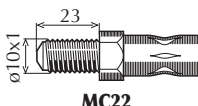
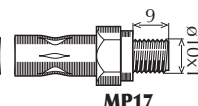
TT	02/81-	<b>8376</b>	<>		445	 MC22	 MC22	60522545
TT	02/81-	<b>8377</b>	<>		273	 MC22	 MP17	60522547

### GTV (Mod. 95)

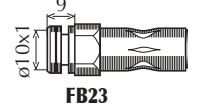
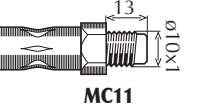
2.0 TS, 2.0 V6 Turbo	95-	<b>8436</b>	<>		435	 FB23	 MC11	60540018
----------------------	-----	-------------	----	--	-----	--	---	----------

### MITO

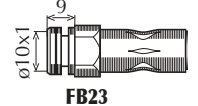
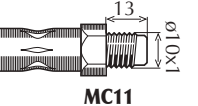
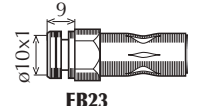
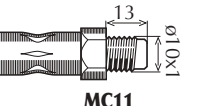
TT	09/08-	<b>80718</b>	<>		430	 FB23	 MC11	51811926
TT	09/08-	<b>80186</b>	<>		162	 FB23	 MC11	55700975

### SPIDER (1750 - 2000)

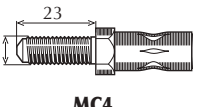
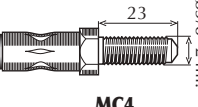
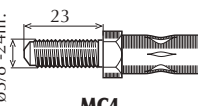
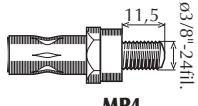
TT	-03/90	<b>8024</b>	<>		390	 MC4	 MC4	60714552
TT	-03/90	<b>8025</b>	<>		380	 MC4	 MP4	60714553

### SPIDER (Mod. 95)

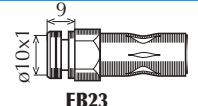
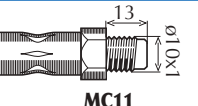
2.0 TS, 2.0 V6 Turbo	09/94-	<b>8436</b>	<>		435	 FB23	 MC11	60540018
----------------------	--------	-------------	----	--	-----	--	---	----------

Legenda/Legend: ○ = Intermedio/Intermediate - ● = Interno/Inner - ▲ = Superiore/Upper - ▼ = Inferiore/Lower

## TUBI FLESSIBILI PER FRENO



L



o.e.

### 50

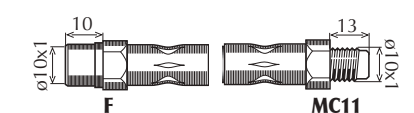
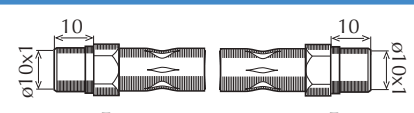
TT	08/74-08/78	8226	<>		290		861611707B
TT	08/74-08/78	8227	<>		180		433611775A

### 80

#### - 08/86

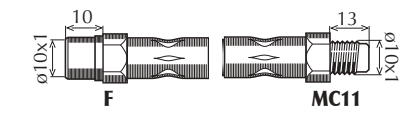
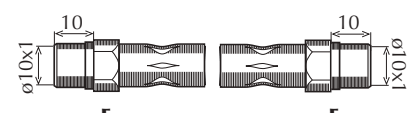
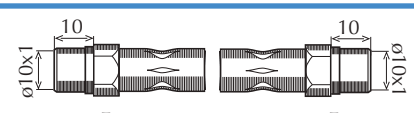
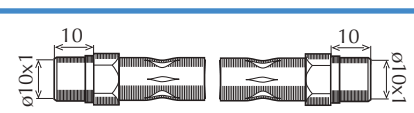
TT	-08/86	8228	<>		310		171611701G
1.3, 1.6, 1.6 GLE	-07/81	8229	<>		160		171611775
TT	08/81-08/86	8227	>		180		433611775A
TT	-08/86	8230	<		200		811611775

#### 09/86-08/91

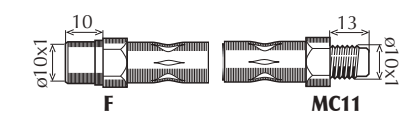
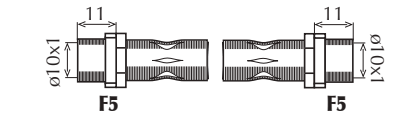
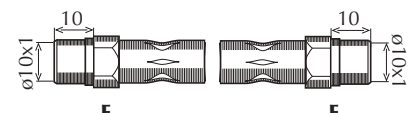
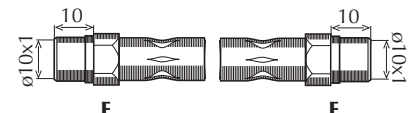
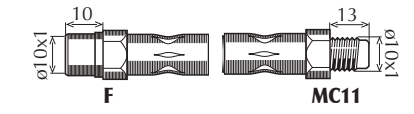
TT	09/86-08/89	8228	<>		310		171611701G
TT	09/89-08/91	8035	<>		310		893611707
TT ( Senza correttore)	09/86-08/91	8041	>		175		811611775A
TT ( Senza correttore)	09/86-08/91	8230	<		200		811611775
TT (Disco)	09/89-08/91	8036	<>		187		893611775A

## TUBI FLESSIBILI PER FRENO

**L**

**o.e.**

### segue 80

#### 09/91-12/94

TT	09/91-12/94	<b>8035</b>	<>		310		893611707
TT (- ABS)	09/91-09/92	<b>8038</b>	<>		225		8A0611775
TT (+ ABS)	09/91-12/94	<b>8037</b>		>	225		8A0611775D
TT (+ ABS)	09/91-12/94	<b>8038</b>		<	225		8A0611775

### 90

#### - 03/87

TT	10/84-03/87	<b>8228</b>	<>		310		171611701G
TT	10/84-03/87	<b>8227</b>		>	180		433611775A
TT	10/84-03/87	<b>8230</b>		<	200		811611775

#### 04/87-07/91

TT	04/87-08/89	<b>8228</b>	<>		310		171611701G
TT (Disco)	09/89-07/91	<b>8036</b>	<>		187		893611775A
TT	04/87-07/91	<b>8227</b>		>	180		433611775A

Legenda/Legend: ○ = Intermedio/Intermediate - ● = Interno/Inner - ▲ = Superiore/Upper - ▼ = Inferiore/Lower

## TUBI FLESSIBILI PER FRENO



L



o.e.

### segue 90

#### segue 04/87-07/91

TT	04/87-07/91	8230	<	200	 F	 F	811611775
----	-------------	------	---	-----	---	--	-----------

### 100

#### 68-76

TT	11/68-12/76	8232	<>	390	 F	 MC11	431611707
----	-------------	------	----	-----	---	---	-----------

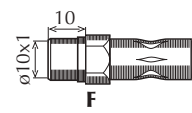
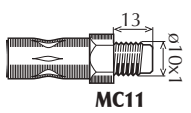
TT	11/68-12/76	8232	<>	390	 F	 MC11	431611707
----	-------------	------	----	-----	---	---	-----------

#### 76-82

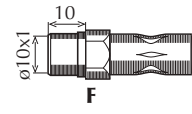
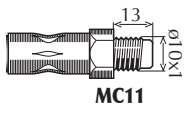
1.6	06/76-07/82	8232	<>	390	 F	 MC11	431611707
-----	-------------	------	----	-----	---	---	-----------

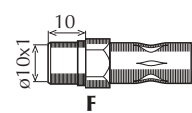
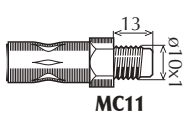
1.6	06/76-07/82	8232	<>	390	 F	 MC11	431611707
-----	-------------	------	----	-----	---	---	-----------

#### 82- 90

TT	08/82-11/90	8228	<>	310	 F	 MC11	171611701G
----	-------------	------	----	-----	---	---	------------

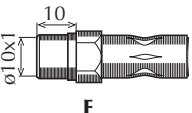
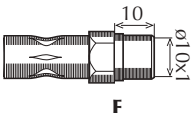
TT	08/82-11/90	8227	<>	180	 F	 F	433611775A
----	-------------	------	----	-----	---	--	------------

#### 90-94

TT	90-94	8030	<>	295	 F5	 F5	171611701G
----	-------	------	----	-----	--	---	------------

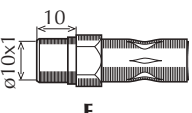
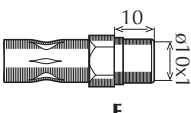
TT (Tamburo)	90-94	8227	<>	180	 F	 F	433611775A
--------------	-------	------	----	-----	---	--	------------

## TUBI FLESSIBILI PER FRENO



L



o.e.

### segue 100

### segue 90-94

TT (Disco)	90-94	8039	<>	240		433611775A
------------	-------	------	----	-----	--	------------

### A1

TT	05/10-	80948	<>	555		6R0611701B
TT	05/10-	8903	<>	165		6Q0611775B

### A2

1,4, 1.4 TDI, 1.6 FSI	02/00-08/05	80172	<>	545		8Z0611707C
TT (all models)	02/00-08/05	80173	<>	216		8Z0611775B

### A3

TT	09/96-03	8616	<>	435		1J0611701
TT	09/96-03	8903	<>	165		6X0611775
TT (alla pinza)	09/96-03	80623	>			1J0611764K
TT (alla pinza)	09/96-03	80622	<			1J0611763K

## TUBI FLESSIBILI PER FRENO



L



o.e.

### A3 (Mod. 2003)

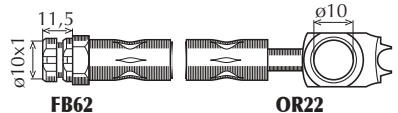
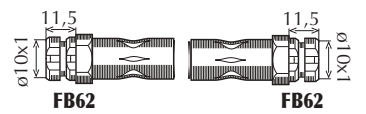
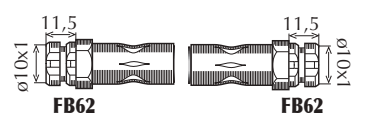
TT (PR:1L,1ZE,1ZF,1ZM)	05/03-	<b>80160</b>	<>	595		1K0611701B
TT (PR: 1LK)		<b>81020</b>	<>	525		1K0611701L
TT	05/03-	<b>80161</b>	<>	257		1K0611775C

### A4 (-09/01)

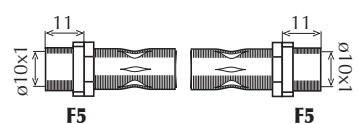
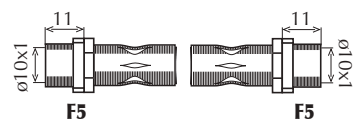
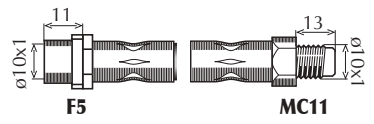
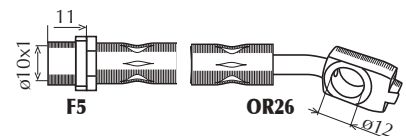
TT	01/95-09/01	<b>8035</b>	<>	310		8D0611707
TT (Intermedio)	01/95-09/01	<b>8061</b>	<>	205		8D0611775E
TT -CH:8DV160000	01/95-	<b>8062</b>	<>	228		8D0611775B
TT CH:8DV160001-	-09/01	<b>8904</b>	<>	240		8D0611775J

### A4 (mod.2001)

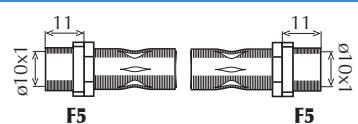
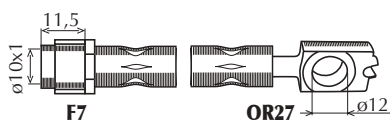
TT	10/00-	<b>80171</b>	<>	328		8E0611707D
TT	10/00-	<b>80254</b>	<>	280		8E0611775H-N

### A4 (mod.2004)

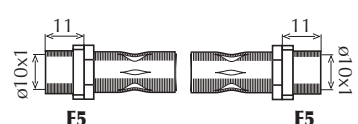
TT	11/04-	<b>80171</b>	<>	328		8E0611707D
----	--------	--------------	----	-----	--	------------

## TUBI FLESSIBILI PER FRENO

**L**

**o.e.**

### segue A4 (mod.2004)

TT	11/04-	<b>80254</b>	<>	280		8E0611775H-N
----	--------	--------------	----	-----	--	--------------

### A4 (Mod.2008)

TT	11/07-	<b>80721</b>	<>	520		8K0611707D
TT	11/07-	<b>80655</b>	<>	445		8K0611775F

### A5

TT	06/07-	<b>80721</b>	<>	520		8K0611707D
TT	06/07-	<b>80655</b>	<>	445		8K0611775F

### A6 (Mod.94)

TT	06/94-02/97	<b>8030</b>	<>	295		4A0611707
TT (Intermedio)	06/94-02/97	<b>8227</b>	<>	180		433611775A
TT	06/94-02/97	<b>8906</b>	<>	205		4A0611775B
TT 4x4	06/94-02/97	<b>8043</b>	<>	235		4B0611775

### A6 (Mod.97)

TT	02/97-01/05	<b>8035</b>	<>	310		8D0611707
----	-------------	-------------	----	-----	--	-----------

## TUBI FLESSIBILI PER FRENO





L

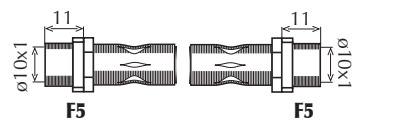

o.e.

### segue A6 (Mod.97)

TT (Intermedio)	02/97-01/05	<b>8905</b>	<>	195		4B0611775
TT (Quattro)	02/97-01/05	<b>80248</b>	<>	330		4B0611775C

### A6 (Mod.2004)

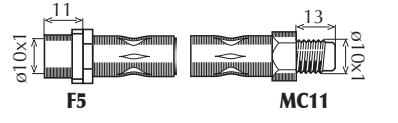
TT	05/04-	<b>80164</b>	<>	340		4F0611707
TT	05/04-	<b>80165</b>	<>	350		4F0611775

### A6 (Mod.2011)

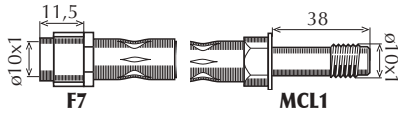
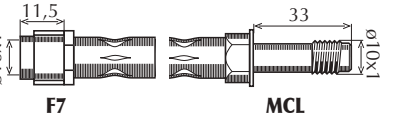
TT	03/11-	<b>81023</b>	<>	715		4G0611707E
TT	03/11-	<b>81024</b>	<>	470		4G0611775C

### A7

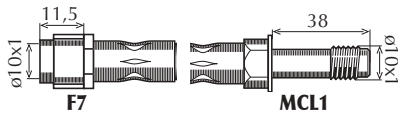
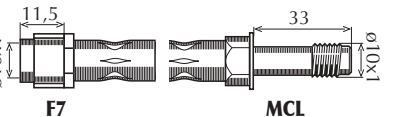
TT	10/10-	<b>81023</b>	<>	715		4G0611707E
TT	10/10-	<b>81024</b>	<>	470		4G0611775C

### A8 (94-02)

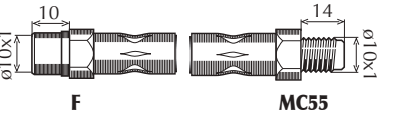
TT	03/94-09/02	<b>80163</b>	<>	384		4D0611707F
3.7	11/98-09/02	<b>80317</b>	<>	280		4D0611775B



## TUBI FLESSIBILI PER FRENO

**L**

**o.e.**

### segue A8 (94-02)

TT (Quattro)	03/94-09/02	<b>80317</b>	<>	280	<p><b>F</b>      <b>MC55</b></p>	4D0611775B
--------------	-------------	--------------	----	-----	----------------------------------	------------

### A8 (Mod 2002)

TT	10/02-	<b>81012</b>	<>	450	<p><b>FB49</b>      <b>FB62</b></p>	3D0611701E
TT	10/02-	<b>8061</b>	<>	205	<p><b>F5</b>      <b>F5</b></p>	8D0611775E

### ALLROAD

TT	05/00-08/05	<b>80415</b>	<>	355	<p><b>F5</b>      <b>F5</b></p>	4Z7611707A
----	-------------	--------------	----	-----	---------------------------------	------------

### Q3

TT	06/11-	<b>81025</b>	<>	590	<p><b>FB62</b>      <b>OR22</b></p>	5N0611701A
TT	06/11-	<b>81026</b>	<>	270	<p><b>FB62</b>      <b>OR22</b></p>	5N0611775A

### Q5

TT	11/08-	<b>80654</b>	<>	535	<p><b>F7</b>      <b>MCL</b></p>	8R0611707B
TT	11/08-	<b>80655</b>	<>	445	<p><b>F7</b>      <b>MCL</b></p>	8K0611775F

### Q7

TT	11/02-	<b>80169</b>	<>	542	<p><b>F7</b>      <b>F7</b></p>	7L0611701A
----	--------	--------------	----	-----	---------------------------------	------------

## TUBI FLESSIBILI PER FRENO



L



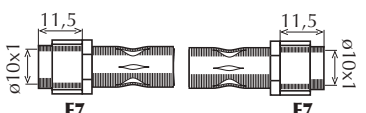

o.e.

### segue Q7

TT	11/02-	<b>80170</b>	<>	426		7L0611776A
----	--------	--------------	----	-----	--	------------

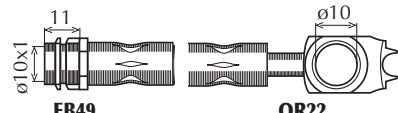
### TT (8N3)

TT	-06/06	<b>80275</b>	<>	575		8N0611707A
----	--------	--------------	----	-----	--	------------

TT (Mod.1LK1LM1LN)	-06/06	<b>8903</b>	<>	165		6X0611775
--------------------	--------	-------------	----	-----	--	-----------

### TT (Mod 2007)

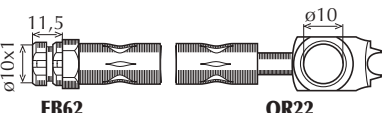
TT (Mod. 1LL,1LJ)	10/06-	<b>80722</b>	<>	635		8J0611701C
-------------------	--------	--------------	----	-----	--	------------

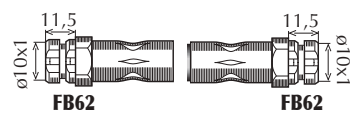
TT (Mod.1LK1LM1LN)	10/06-	<b>80723</b>	<>	580		8J0611701D
--------------------	--------	--------------	----	-----	--	------------

TT - TT	10/06-	<b>80724</b>	<>	280		8J0611775B
---------	--------	--------------	----	-----	--	------------

## TUBI FLESSIBILI PER FRENO



L



o.e.

### BRAVA 4x4

TT	88-	8226	<>		435	<p>F MC11</p>	562304
----	-----	------	----	--	-----	---------------	--------

### MIDI 4WD

TT	88-	8697	<>		545	<p>FB13 OR13</p>	94113583
----	-----	------	----	--	-----	------------------	----------

**TUBI FLESSIBILI PER FRENO**

**L**

**o.e.**
**Serie 1 (E87)**

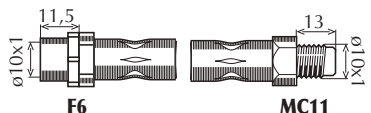
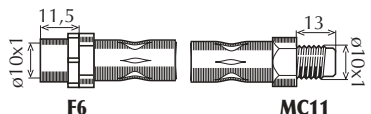
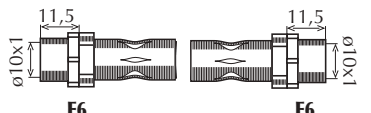
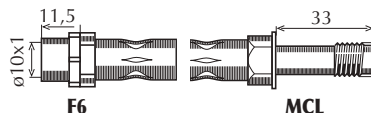
TT	09/04-07/05	<b>80264</b>	<>		483		34306767458
TT	07/05-	<b>80266</b>	<>		553		34306771720
TT (Intermedio)	09/04-	<b>80232</b>		○	210		34306762838
TT	09/04-	<b>80330</b>	<>		265		34306768851

**Serie 3 (E21)**

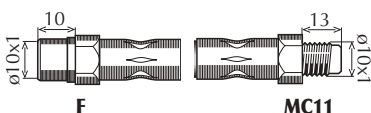
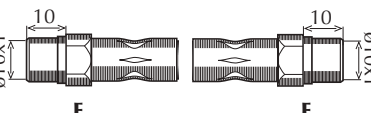
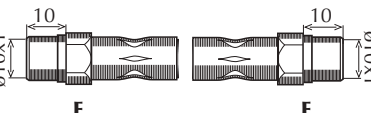
TT	06/75-12/83	<b>8457</b>	<>		300		34321154904
TT	06/75-12/83	<b>8693</b>		▼	225		34324050542
TT	06/75-12/83	<b>8230</b>		▲	200		34324050542

**Serie 3 (E30)**

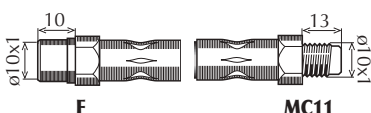
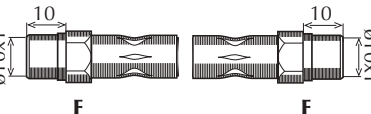
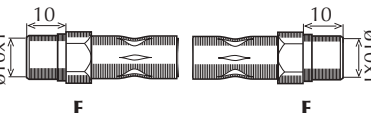
TT	03/82-12/91	<b>8457</b>	<>		300		34321154904
TT	03/82-12/91	<b>8693</b>	<>		225		34321159878
TT (disco)	03/82-12/91	<b>8230</b>	<>		200		34324050542

## TUBI FLESSIBILI PER FRENO





L

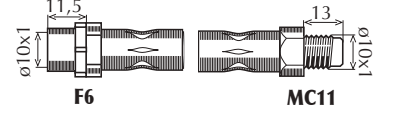
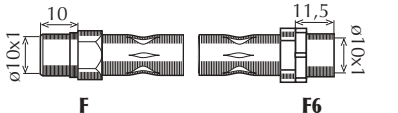
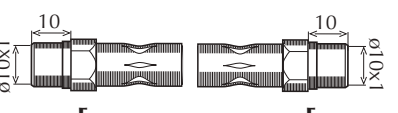
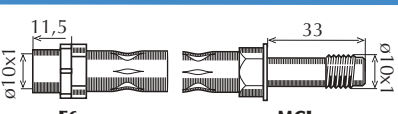
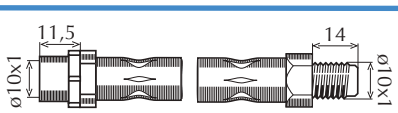

o.e.

### Serie 3 (E36)

TT	09/90-12/98	<b>8907</b>	<>		453		34321159717
TT	09/90-12/98	<b>8908</b>	<>		223		34321159524
TT (disco)	03/82-12/98	<b>8693</b>	<>		225		34321159881
TT (ABS, ASC) (-316,318 TDS)	03/82-12/98	<b>8909</b>	<>		500		34301165174
M3	09/90-08/00	<b>80308</b>	<>		480		34322227381
M3 (alla pinza)	09/90-08/00	<b>80320</b>	<>		245		34322227388

### Serie 3 (E46)

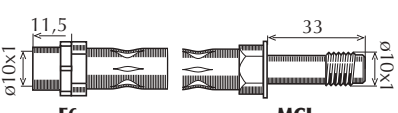
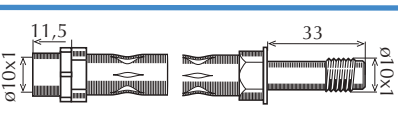
TT	03/98-02/05	<b>8910</b>	<>		455		34321165587
TT	03/98-02/05	<b>8909</b>	<>		500		34301165174

### Serie 3 (E90)

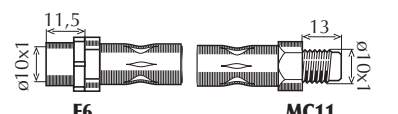
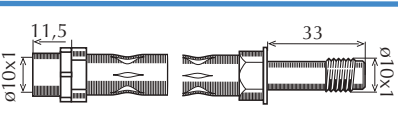
TT	01/05-	<b>80266</b>	<>		553		34306771720
TT	01/05-	<b>80330</b>	<>		265		34306768851

**TUBI FLESSIBILI PER FRENO**

**L**

**o.e.**
**Serie 3 (F30)**

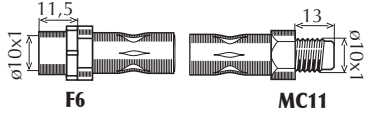
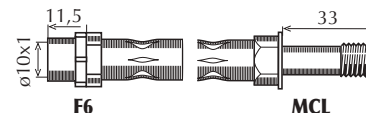
TT	10/11-	<b>81027</b>	<>		615	 <p>F6 MC11</p>	34306792254
TT	10/11-	<b>80330</b>	<>		265	 <p>F6 MCL</p>	34306792253

**Serie 5 (E12)**

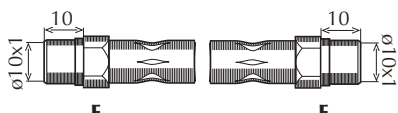
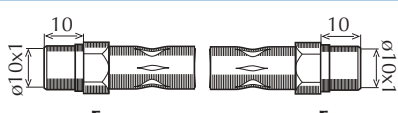
TT	08/72-08/81	<b>8695</b>	<>		315	 <p>F F</p>	34321115694
TT	08/72-08/81	<b>8693</b>	<>		225	 <p>F F</p>	34321115695

**Serie 5 (E28)**

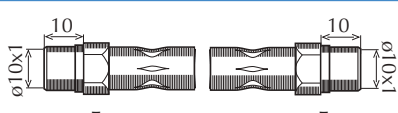
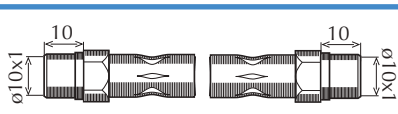
TT	06/81-12/87	<b>8458</b>	<>		420	 <p>F MC11</p>	34321159889
TT	06/81-12/87	<b>8693</b>	<>		225	 <p>F F</p>	34324050542
TT (disco)	06/81-12/87	<b>8230</b>	<>		200	 <p>F F</p>	34321159881

**Serie 5 (E34)**

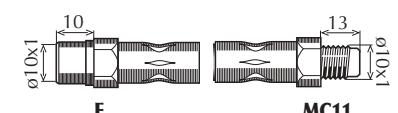
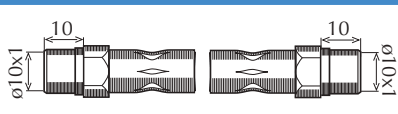
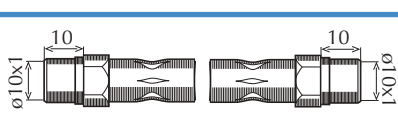
TT	01/88-09/95	<b>8458</b>	<>		420	 <p>F MC11</p>	34321159889
TT	01/88-09/95	<b>8693</b>	<>		225	 <p>F F</p>	34324050542
TT (disco)	01/88-09/95	<b>8230</b>	<>		200	 <p>F F</p>	34321159881

## TUBI FLESSIBILI PER FRENO



L



o.e.

### Serie 5 (E39)

TT	11/95-06/03	<b>8911</b>	<>		440	<p><b>F6</b>      <b>MC11</b></p>	34301165249
TT (Intermedio)	11/95-06/03	<b>80238</b>	>		125	<p><b>F</b>      <b>F</b></p>	34321162612
TT (Intermedio)	11/95-06/03	<b>80370</b>	<		125	<p><b>FA7</b>      <b>FA7</b></p>	34321162616
TT	11/95-06/03	<b>8912</b>	<>		325	<p><b>F</b>      <b>MCL</b></p>	34301165190
TT Touring	11/95-06/03	<b>8913</b>	<>		305	<p><b>F</b>      <b>MC11</b></p>	34301166248

### Serie 5 (E60)

TT	07/03-	<b>80281</b>	<>		580	<p><b>F6</b>      <b>MC55</b></p>	34326767390
TT	07/03-	<b>8457</b>	<>		300	<p><b>F</b>      <b>MC11</b></p>	34321159890

### Serie 5 Granturismo (F07)

TT	10/09-	<b>81028</b>	<>		730	<p><b>F7</b>      <b>MG9</b></p>	34326775261
TT	10/09-	<b>81029</b>	<>		330	<p><b>F</b>      <b>MCL1</b></p>	34326775259

### Serie 5 (F10)

TT	09/10-	<b>81028</b>	<>		730	<p><b>F7</b>      <b>MG9</b></p>	34326775261
----	--------	--------------	----	--	-----	----------------------------------	-------------

**TUBI FLESSIBILI PER FRENO**

**L**

**o.e.**
**segue Serie 5 (F10)**

TT	09/10-	<b>81029</b>	<>	330		34326775259
----	--------	--------------	----	-----	--	-------------

**Serie 6 (E24)**

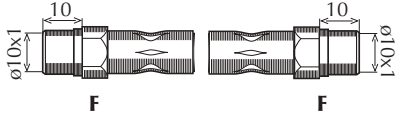
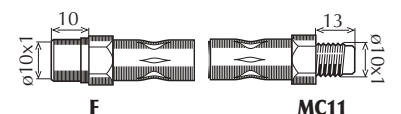
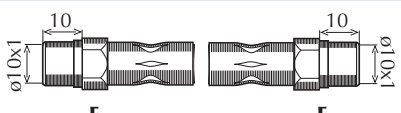
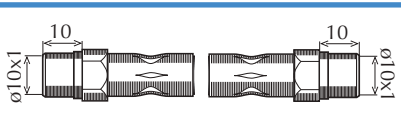
TT	09/79-04/82	<b>8695</b>	<>	315		34321115694
TT	05/82-05/89	<b>8458</b>	<>	420		34321159889
TT	09/79-05/89	<b>8230</b>	<>	200		34321159881
TT (all pinza)	06/78-05/89	<b>8693</b>	<>	225		34324050542

**Serie 6 (E63,E64)**

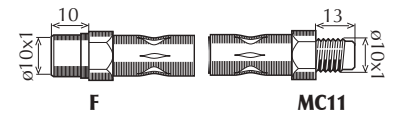
TT	01/04-	<b>8457</b>	<>	300		34321159890
----	--------	-------------	----	-----	--	-------------

**Serie 7 (E23)**

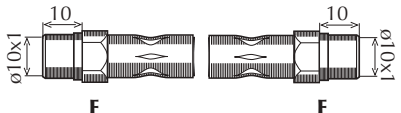
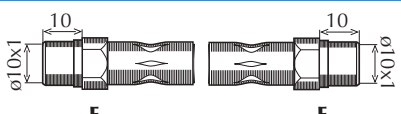
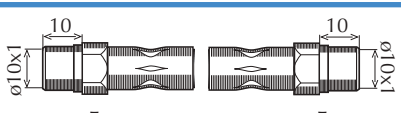
TT	04/77-05/86	<b>8695</b>	<>	315		34321115694
TT	04/77-05/86	<b>8230</b>	<>	200		34321159881
TT (all pinza)	04/77-05/86	<b>8693</b>	<>	225		34324050542

**Serie 7 (E32)**

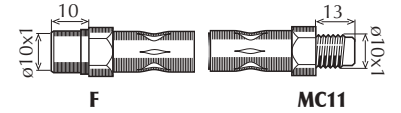
TT	09/86-09/94	<b>8458</b>	<>	420		34321159889
----	-------------	-------------	----	-----	--	-------------



## TUBI FLESSIBILI PER FRENO



L



o.e.

### segue Serie 7 (E32)

TT	09/86-09/94	<b>8230</b>	<>	200		34321159881
TT (all pinza)	09/86-09/94	<b>8693</b>	<>	225		34324050542

### Serie 7 (E38)

TT	10/94-11/01	<b>80336</b>	<>	385		34301163155
TT (Intermedio)	10/94-11/01	<b>80238</b>	>	125		34321162612
TT (Intermedio)	10/94-11/01	<b>80370</b>	<	125		34321162616
TT (all pinza)	10/94-11/01	<b>80331</b>	<>	305		34301163080

### Serie 7 (E65,E66)

TT	11/01-	<b>80949</b>	<>	590		34326753610
TT	11/01-	<b>8457</b>	<>	300		34321159890

### Serie 8 (E31)

TT	04/90-12/99	<b>8458</b>	<>	420		34321159889
TT (Intermedio)	04/90-12/99	<b>80238</b>	>	125		34321162612

Legenda/Legend: ○ = Intermedio/Intermediate - ● = Interno/Inner - ▲ = Superiore/Upper - ▼ = Inferiore/Lower

**TUBI FLESSIBILI PER FRENO**

**o.e.**
**segue Serie 8 (E31)**

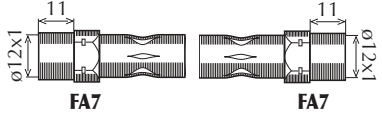
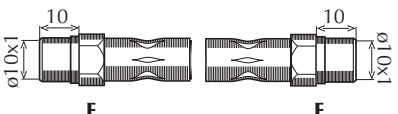
TT (Intermedio)	04/90-12/99	<b>80370</b>	<	125		34321162616
TT	04/90-12/99	<b>8693</b>	<>	225		34324050542

**X1 (E84)**

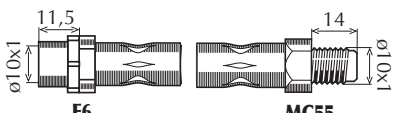
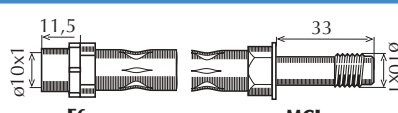
TT	10/09-	<b>80656</b>	<>	585		34306787316
TT	10/09-	<b>80330</b>	<>	265		34306768851

**X3 (E83)**

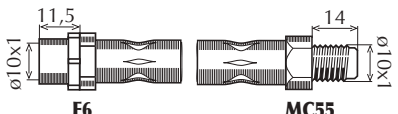
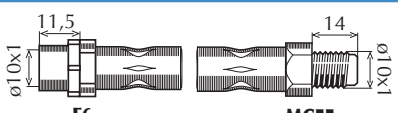
TT	01/04-	<b>80305</b>	<>	545		34303411443
TT	01/04-	<b>80416</b>	<>	540		34303411444

**X3 (F25)**

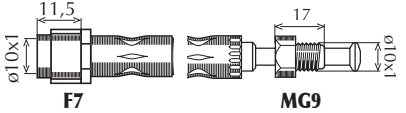
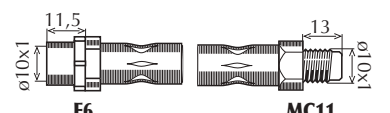
TT	09/10-	<b>80950</b>	<>	740		34306787512
TT	09/10-	<b>80951</b>	<>	305		34306797527

**X5 (E53)**

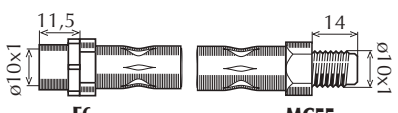
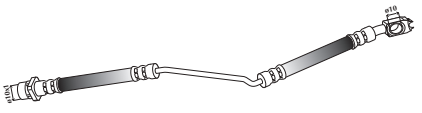
TT	05/00-	<b>80294</b>	<>	545		34301166118
TT	05/00-	<b>80417</b>	>			34301165766

## TUBI FLESSIBILI PER FRENO



L



o.e.

### segue X5 (E53)

TT	05/00-	<b>80418</b>	<				34301165765
----	--------	--------------	---	--	--	--	-------------

### X5 (E70)

TT	02/07-	<b>80657</b>	<>		630		34306788436
TT	02/07-	<b>80658</b>	<>		465		34306788437

### X6 (E71)

TT	05/08-	<b>80657</b>	<>		630		34306788436
TT	05/08-	<b>80658</b>	<>		465		34306788437

### Z3

TT	04/96-	<b>8907</b>	<>		453		34321159717
TT (all pinza)	04/96-	<b>8693</b>	<>		225		34324050542

### Z4 (E85)

TT	02/03-	<b>8910</b>	<>		455		34326766966
TT sdrive (all pinza)	02/03-	<b>80726</b>	<>		680		34206784620
TT	02/03-	<b>80727</b>	<				34306774341

**TUBI FLESSIBILI PER FRENO**

**L**

**o.e.**
**segue Z4 (E85)**

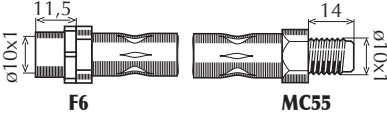
TT	02/03-	<b>80728</b>	>				34306774342
TT (all pinza)	02/03-	<b>80729</b>	<>	235		 <b>F6</b> <b>MC55</b>	34326757744

**Mini (R50, R53)-Mini Cabriolet (R52)**

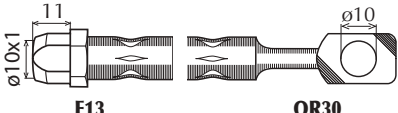
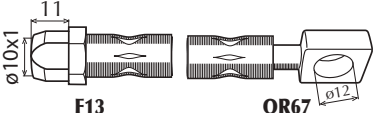
TT	06/01-04/06	<b>80633</b>	<>	580		 <b>F13</b> <b>OR30</b>	34321503079
TT	06/01-04/06	<b>80634</b>	<>	445		 <b>F13</b> <b>OR67</b>	34306760221

**Mini (R56) - Mini Cabriolet (R57)**

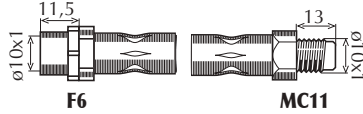
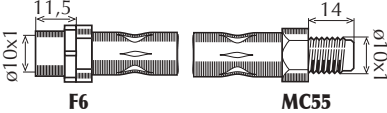
TT	05/06-	<b>80725</b>	<>	555		 <b>F6</b> <b>MC11</b>	34306788442
TT	05/06-	<b>80635</b>	<>	440		 <b>F6</b> <b>MC55</b>	34306781667

**MINI Clubman (R55)**

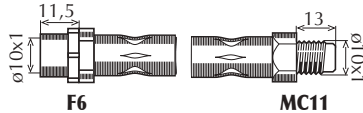
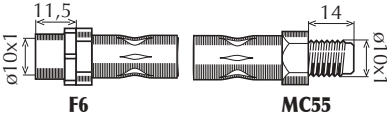
TT	10/07-	<b>80725</b>	<>	555		 <b>F6</b> <b>MC11</b>	34306788442
TT	10/07-	<b>80635</b>	<>	440		 <b>F6</b> <b>MC55</b>	34306788443

**MINI Countryman (R60)**

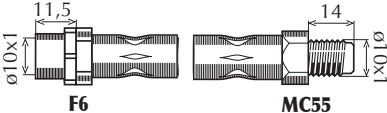
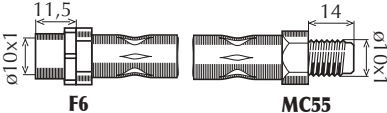
TT	06/10-	<b>81030</b>	<>	550		 <b>F6</b> <b>MC55</b>	34309804831
TT	06/10-	<b>81031</b>	<>	390		 <b>F6</b> <b>MC55</b>	34309804832

## TUBI FLESSIBILI PER FRENO



L



o.e.

### AVEO

TT	04/08-	<b>80367</b>	<>		355	<p><b>FB51</b>      <b>OR2</b></p>	96534545
TT	04/08-	<b>80437</b>	<>		230	<p><b>FB88</b>      <b>FB88</b></p>	96407749



### CAPTIVA

TT	06/06-	<b>80659</b>	<		485	<p><b>FB112</b>      <b>OR203</b></p>	96625949
TT	06/06-	<b>80660</b>	>		485	<p><b>FB112</b>      <b>OR203</b></p>	96625950
TT	06/06-	<b>80661</b>	>		500	<p><b>FB112</b>      <b>OR243</b></p>	96625919
TT	06/06-	<b>80662</b>	<		500	<p><b>FB112</b>      <b>OR243</b></p>	96625920

### CRUZE

TT	05/09-	<b>80832</b>	<>			<p><b>F14</b>      <b>OR65</b></p>	12774865
TT	05/09-	<b>80733</b>	<				13320679
TT	05/09-	<b>80734</b>	>				13320680

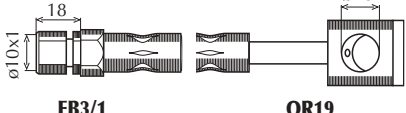
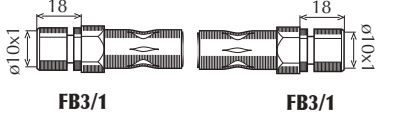
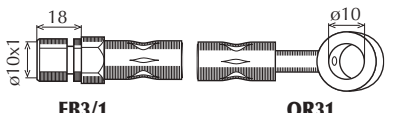
**TUBI FLESSIBILI PER FRENO**

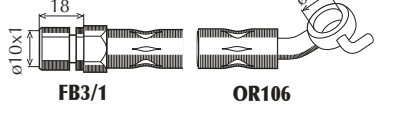
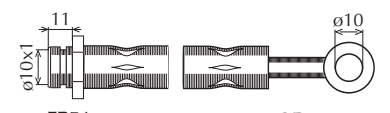
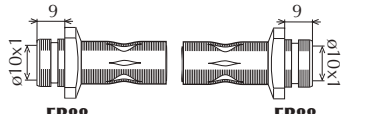
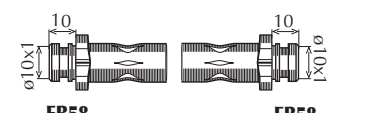
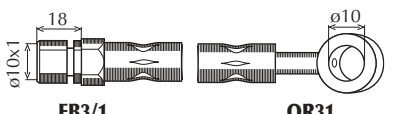
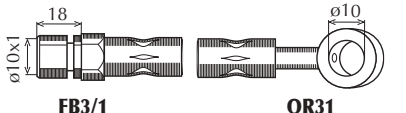
<b>ESPERO</b>							
1.8, 2.0	03/95-09/98	<b>8615</b>	<>		340	 <b>FB3/1</b> <b>OR19</b>	96212323
1.8, 2.0	03/95-09/98	<b>8541</b>		<>	195	 <b>FB3/1</b> <b>FB3/1</b>	96179489
<b>EVANDA</b>							
TT	08/02-	<b>80290</b>	<>		580	 <b>FB3/1</b> <b>OR31</b>	96483077
TT	08/02-	<b>80435</b>		>	400	 <b>FB3/1</b> <b>OR108</b>	96328351
TT	08/02-	<b>80436</b>		<	400	 <b>FB3/1</b> <b>OR106</b>	96328350
<b>KALOS</b>							
TT	09/02-	<b>80367</b>	<>		355	 <b>FB51</b> <b>OR2</b>	96534545
TT	09/02-	<b>80437</b>		>	230	 <b>FB88</b> <b>FB88</b>	96407749
TT	09/02-	<b>80296</b>		<	225	 <b>FB58</b> <b>FB58</b>	96534546
<b>LACETTI</b>							
TT	02/04-	<b>80312</b>		>	435	 <b>FB3/1</b> <b>OR31</b>	96397201
TT	02/04-	<b>80292</b>		<	435	 <b>FB3/1</b> <b>OR31</b>	96397200

## TUBI FLESSIBILI PER FRENO



L



o.e.

### segue LACETTI

TT	02/04-	80322	▼	450		96387196
TT	02/04-	80288	▲	385		96549725

### LANOS

1.5, 1.6 16V	05/97-	8615	<>	340		96212323
1.8, 2.0	05/97-	8541	<>	195		96179489

### MATIZ

0.8	09/98-	80011	<>	440		96316525
0.8	09/98-	80012	<>	240		96320284

### MATIZ II

0.8, 1.0	03/05-	80011	<>	440		96316525
0.8, 1.0	03/05-	80012	<>	240		96320284

### NEXIA

1.5i, 1.5 16V, 1.8	02/95-	8615	<>	340		96212323
1.5i, 1.5 16V, 1.8	02/95-	8541	<>	195		96179489

Legenda/Legend: ○ = Intermedio/Intermediate - ● = Interno/Inner - ▲ = Superiore/Upper - ▼ = Inferiore/Lower

**TUBI FLESSIBILI PER FRENO**

**NUBIRA I-II**

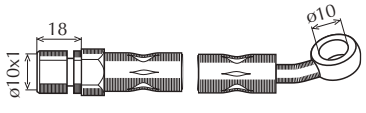
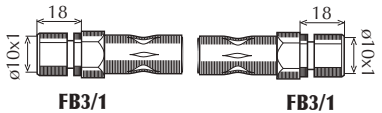
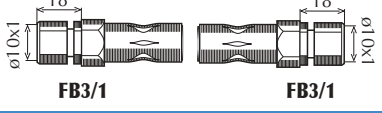
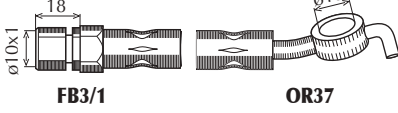
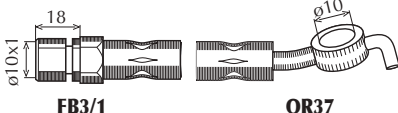
1.6 16V, 2.0 16V	02/97-06/03	<b>80013</b>	<>		425	 <b>FB3/1</b> <b>OR33</b>	96300046
1.6 16V	02/97-06/03	<b>80014</b>	▼		247	 <b>FB3/1</b> <b>FB3/1</b>	96308124
1.6 16V	02/97-06/03	<b>80015</b>	▲		250	 <b>FB3/1</b> <b>FB3/1</b>	96300330
2.0 16V	02/97-06/03	<b>80016</b>	▼		376	 <b>FB3/1</b> <b>OR37</b>	96300350
2.0 16V	02/97-06/03	<b>80017</b>	▲		376	 <b>FB3/1</b> <b>OR37</b>	96300331

**NUBIRA III (Mod 2003)**

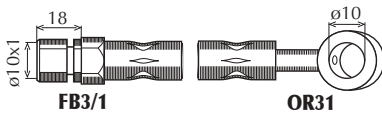
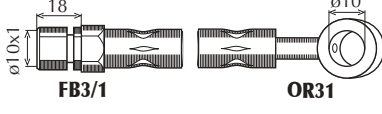
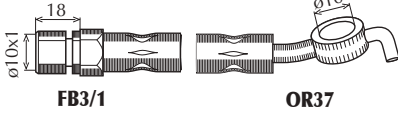
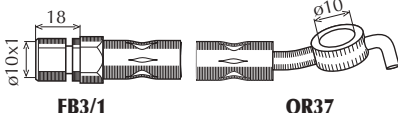
TT	07/03-	<b>80312</b>	▼		435	 <b>FB3/1</b> <b>OR31</b>	96397201
TT	07/03-	<b>80292</b>	▲		435	 <b>FB3/1</b> <b>OR31</b>	96397200
TT	07/03-	<b>80322</b>	▼		450	 <b>FB3/1</b> <b>OR37</b>	96387196
TT	07/03-	<b>80288</b>	▲		385	 <b>FB3/1</b> <b>OR37</b>	96549725

**SPARK**

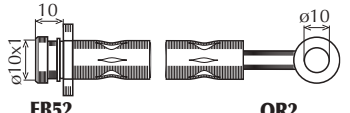
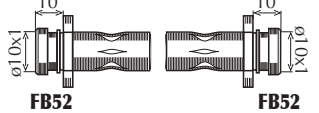
TT	02/10-	<b>80730</b>	<>		360	 <b>FB52</b> <b>OR2</b>	96682950
TT	02/10-	<b>80731</b>	<>		235	 <b>FB52</b> <b>FB52</b>	96682952



## TUBI FLESSIBILI PER FRENO



L



o.e.

### TACUMA (REZZO)

TT (->CH:837873)	09/00-2003	<b>80013</b>	< >		425	<p><b>FB3/1</b>                      <b>OR33</b></p>	96300046
TT (CH:837874->)	2003-	<b>80314</b>	< >		485	<p><b>FB3/1</b>                      <b>OR31</b></p>	96397206
TT	09/00-	<b>80327</b>		▼	310	<p><b>FB3/1</b>                      <b>FB3/1</b></p>	96345555
TT	09/00-	<b>80293</b>		▲	245	<p><b>FB3/1</b>                      <b>FB3/1</b></p>	96264606

## TUBI FLESSIBILI PER FRENO



L



o.e.

### PT CRUISER

#### (- ABS)

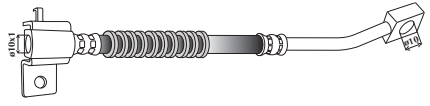
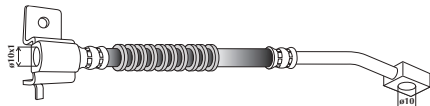
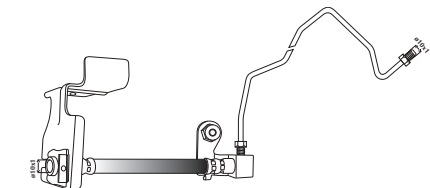
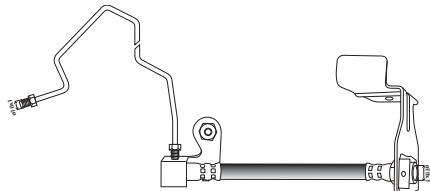
TT	6/00-	<b>80419</b>	▼		450		4509995AC
TT	6/00-	<b>80420</b>	▲		450		4509996AC
TT	6/00-	<b>80421</b>	▼		1160		4860080AD
TT	6/00-	<b>80422</b>	▲		1160		4860081AC

#### (+ ABS)

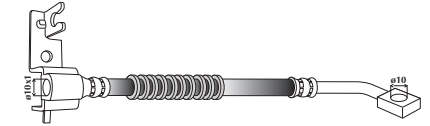
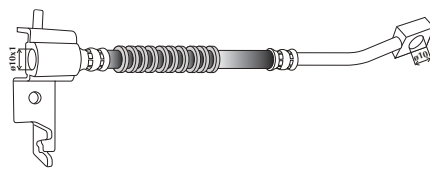
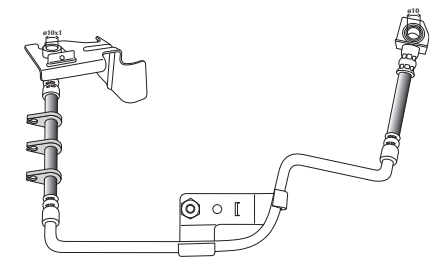
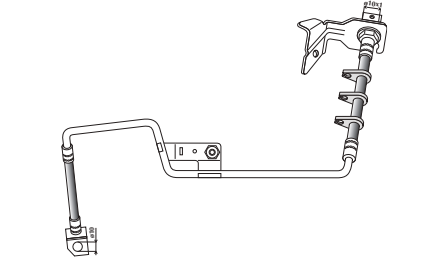
TT	6/00-	<b>80423</b>	▼		450		4860068AC
TT	6/00-	<b>80424</b>	▲		450		4860069AB
TT	6/00-	<b>80425</b>	▼		860		4860082AE
TT	6/00-	<b>80426</b>	▲		880		4860083AD

## TUBI FLESSIBILI PER FRENO



L



o.e.

### VOYAGER I

TT	08/84-01/95	<b>80427</b>	▼		580		4423446
TT	08/84-01/95	<b>80428</b>	▲		580		4423447
TT	08/84-01/95	<b>80429</b>	<>		440	 16 16 ø10x1 ø10x1 <b>FB87</b> <b>FB87</b>	4383838

### VOYAGER II

TT	02/95-3/01	<b>80430</b>	▼		510		4797620AC
TT	02/95-3/01	<b>80431</b>	▲		510		4797621
TT (Tamburo)	02/95-3/01	<b>80432</b>	<>		440	 10 10 ø10x1 ø10x1 <b>FB72</b> <b>FB72</b>	4683290
TT (Disco)	02/95-3/01	<b>80433</b>	▼		320		4721038
TT (Disco)	02/95-3/01	<b>80434</b>	▲		320		4721039

### VOYAGER III

TT	01/01-08/07	<b>80920</b>	▲				4683791AC
----	-------------	--------------	---	--	--	--	-----------

## TUBI FLESSIBILI PER FRENO



L



o.e.

### segue VOYAGER III

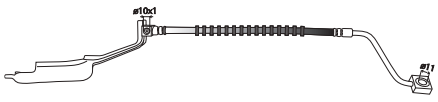
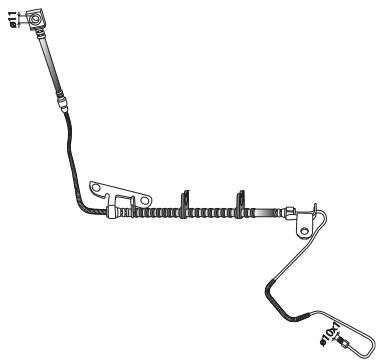
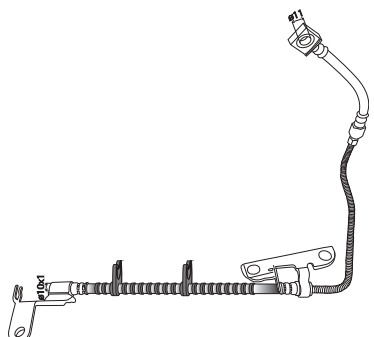
TT	01/01-08/07	<b>80921</b>	▼				4683790AC
TT	01/01-08/07	<b>80922</b>	▲				4721325AA
TT	01/01-08/07	<b>80923</b>	▼				4721324AA

### VOYAGER IV

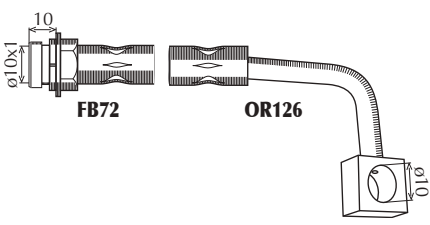
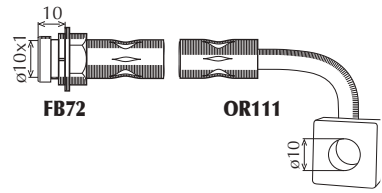
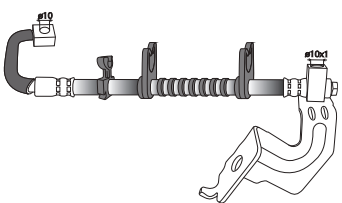
TT	10/07-	<b>80735</b>	▲		390		04683997AH
TT	10/07-	<b>80736</b>	▼		380		04683996AH
TT	10/07-	<b>80737</b>	▲				04721975AC

## TUBI FLESSIBILI PER FRENO



L



o.e.

### segue VOYAGER IV

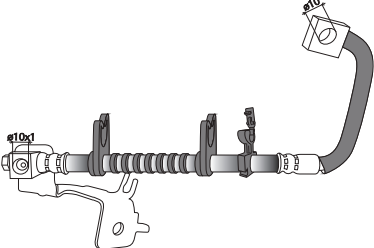
TT	10/07-	80738		V		04721976AC
----	--------	-------	--	---	--	------------

## TUBI FLESSIBILI PER FRENO



L



o.e.

### AX

#### (- ABS)

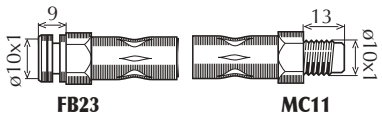
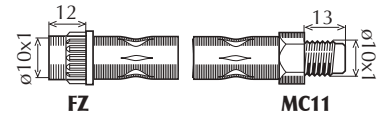
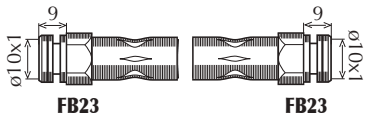
TT ->CH:O5105	87-	<b>8386</b>	<>		352		75492063
TT CH:O5106->	-98	<b>8317</b>	<>		325		96102107
TT ->CH:O6321	87-	<b>8351</b>	<>		218		95599101

#### (+ ABS)

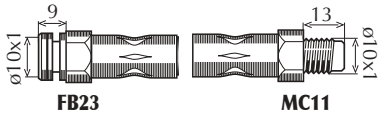
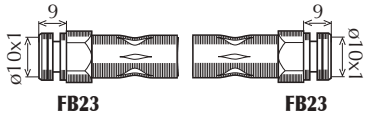
TT	87-98	<b>8386</b>	<>		352		75492063
TT	87-98	<b>8548</b>	<>		235		96124223

### BERLINGO

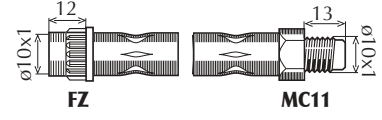
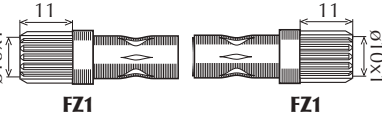
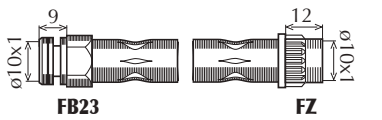
TT	07/96-	<b>8485</b>	<>		465		480685
TT	07/96-CH:09533	<b>8561</b>	<>		255		480686
TT	CH:09534-	<b>80227</b>	<>		260		4806E3

### BERLINGO (Mod.2008)

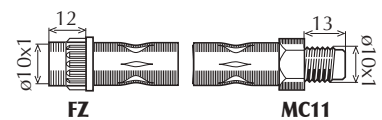
TT	04/08-	<b>80440</b>	<>		445		4806G4
----	--------	--------------	----	--	-----	--	--------

## TUBI FLESSIBILI PER FRENO



L



o.e.

### BX

TT (- ABS)	09/82-12/94	8575	<>		460	<p>FB46 MC11</p>	95494973
TT (+ ABS)	09/82-12/94	8029	<>		460	<p>FB47 MC11</p>	95632790

### C1

TT	06/05-	80438	>		510	<p>FB77 OR127</p>	4806E2
TT	06/05-	80439	<		510	<p>FB77 OR127</p>	4806E1
TT	06/05-	80373	<>		255	<p>FB77 FB77</p>	4806F6

### C2

TT	09/03-	80003	<>		480	<p>FZ MC11</p>	4806A9
TT	09/03-	80004	<>		205	<p>FB23 FZ</p>	4806C0

### C3

TT	02/02-	80003	<>		480	<p>FZ MC11</p>	4806A9
TT	02/02-	80004	<>		205	<p>FB23 FZ</p>	4806C0

### C3 (Mod.2009) - DS3

TT	11/09-	80741	<>		525	<p>FZ MC11</p>	4806K7
----	--------	-------	----	--	-----	----------------	--------

## TUBI FLESSIBILI PER FRENO



L



o.e.

### segue C3 (Mod.2009) - DS3

TT	11/09-	80744	<>	185		4806K8
----	--------	-------	----	-----	--	--------

### C3 Picasso

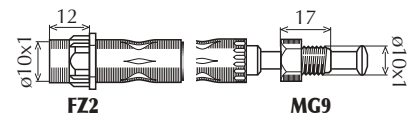
TT	02/09-	80349	<>	530		4806G1
----	--------	-------	----	-----	--	--------

TT	02/09-	80319	<>	220		4806G2
----	--------	-------	----	-----	--	--------

### C4

TT	11/04-	8940	<>	445		4806A0
----	--------	------	----	-----	---	--------

TT	11/04-	8941	<>	210		4806A1
----	--------	------	----	-----	--	--------

### C4 (Mod. 2009) - DS4

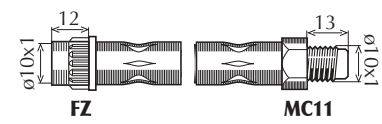
TT	11/09-	81032	<>	465		4806N6
----	--------	-------	----	-----	--	--------

TT DS4	04/11-	8941	<>	210		4806A1
--------	--------	------	----	-----	--	--------

### C4 Picasso - Gran Picasso

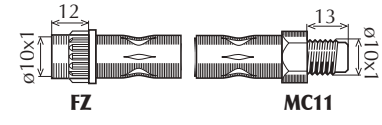
TT	02/07-	80440	<>	445		4806G4
----	--------	-------	----	-----	--	--------

TT	02/07-	80441	<>	235		4806G5
----	--------	-------	----	-----	--	--------



## TUBI FLESSIBILI PER FRENO



L



o.e.

### C5

TT	03/01-	80005	<>		580		480697
TT	03/01-	80006	<>		260		480698

### C5 (Mod.2008)

TT	02/08-	80952	▼				4806J4
TT	02/08-	80953	▲				4806J3
TT	02/08-	80226	▼				4806K3
TT	02/08-	80225	▲				4806K2

### C6

TT	09/05-	80224	▼				4806G0
TT	09/05-	80223	▲				4806F9

## TUBI FLESSIBILI PER FRENO



L



o.e.

### segue C6

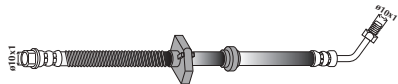
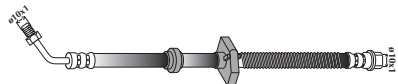
TT	09/05-	80226	▼				4806K3
TT	09/05-	80225	▲				4806K2

### C8

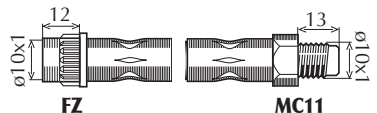
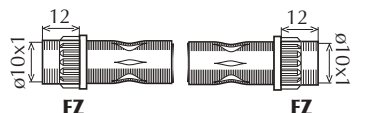
TT (- 3.0 V6)	08/02-	80007	<>		490		1484536080
TT	08/02-	8573	<>		275		480667

### C-Crosser

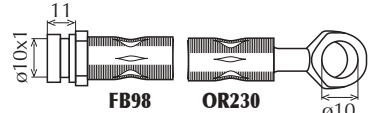
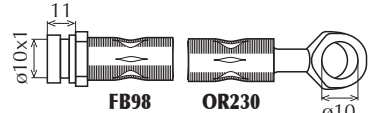
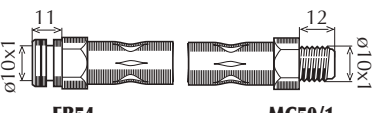
TT	02/07-	80663	▲		630		4806H8
TT	02/07-	80664	▼		630		4806H9
TT	02/07-	80665	<>		305		4806J0

### EVASION

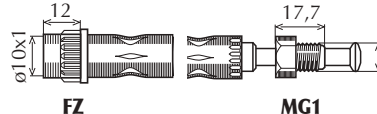
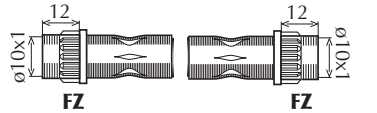
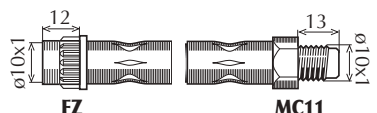
TT	06/94-07/02	8569	<>		515		480682
TT (disco) (Intermedio)	06/94-07/02	8573	<>		275		480667
TT	06/94-07/02	8570	<>		325		480668

## TUBI FLESSIBILI PER FRENO



L



o.e.

### NEMO

TT	02/08-	80745	<>		430	<p>FB23 MC11</p>	4806J9
TT	02/08-	80842	<>		200	<p>FB23 FB23</p>	4806K0

### LN - LNA

LN (602), LNA (652)	10/76-88	8383	<>		370	<p>FB23 MC11</p>	91500900
LNA (1124)	07/82-88	8387	>		370	<p>FB23 MC11</p>	95494014
LNA (1124)	07/82-88	8386	<		352	<p>FB23 MC11</p>	75492063
LN - LNA TT	07/82-88	8384	>		277	<p>FB23 FB23</p>	7910018158
LN - LNA TT	07/82-88	8385	<		297	<p>FB23 MC11</p>	7910022622

### SAXO

TT (ruota a 3 fori) ->CH:O08093	02/96-	8620	<>		355	<p>FZ MC11</p>	480655
TT (ruota a 4 fori) ->CH:O08093	02/96-	8570	<>		325	<p>FZ MC11</p>	480681
TT CH:O08094->		8515	<>		315	<p>FZ MC11</p>	480656
TT	02/96-	8516	>		220	<p>FZ FZ</p>	480657

Legenda/Legend: ○ = Intermedio/Intermediate - ● = Interno/Inner - ▲ = Superiore/Upper - ▼ = Inferiore/Lower

## TUBI FLESSIBILI PER FRENO



L



o.e.

### segue SAXO

TT	02/96-	<b>8518</b>	<	220		480661
----	--------	-------------	---	-----	--	--------

### VISA

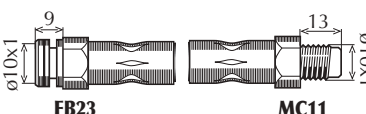
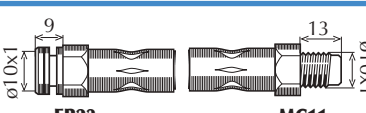
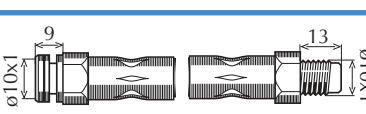
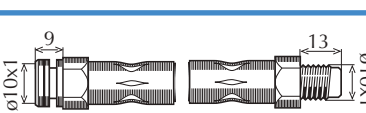
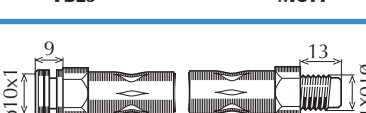
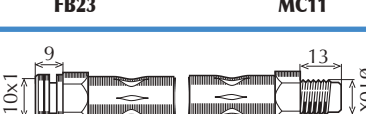
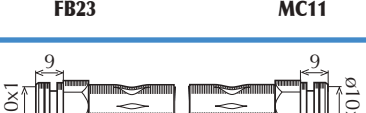
TT (- 1.7 D, 1.6 GTi) ( 4 Marce)	09/78-86	<b>8386</b>	<>	352		75492063
TT (- 1.7 D, 1.6 GTi) ( 5 Marce)	09/78-86	<b>8383</b>	>	370		91500900
TT (- 1.7 D, 1.6 GTi) ( 5 Marce)	09/78-86	<b>8386</b>	<	352		75492063
1.6 Gti	01/84-86	<b>8529</b>	<>	435		480631
1.7 D	04/84-86	<b>8528</b>	<>	350		480629
TT	09/78-86	<b>8387</b>	>	370		95494014
TT	09/78-86	<b>8384</b>	<	277		7910018158

### XANTIA

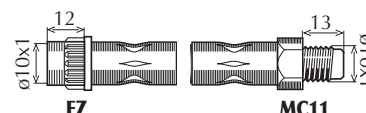
TT	93-	<b>8577</b>	<>	385		96109017
----	-----	-------------	----	-----	--	----------

### XM

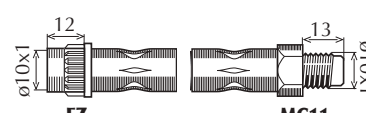
TT	05/89-10/00	<b>80265</b>	<>	575		96037346
----	-------------	--------------	----	-----	--	----------

## TUBI FLESSIBILI PER FRENO

**L**

**o.e.**

### XSARA

Berlina 1.4,1.6,1.8,1.9 D (-ABS)	04/97-	<b>8485</b>	<>		465	 <b>FZ</b> <b>MC11</b>	480685
TT (- Berl. 1.4, 1.6, 1.8, 1.9 D (-ABS))	04/97-	<b>8519</b>	<>		484	 <b>FZ</b> <b>MC11</b>	480691
Berlina 1.4,1.6,1.8,1.9 D (-ABS)	04/97-	<b>8548</b>	<>		235	 <b>FB23</b> <b>FB23</b>	480665
TT (- Berl. 1.4, 1.6, 1.8, 1.9 D (-ABS))	04/97-	<b>8626</b>	>		240	 <b>FB23</b> <b>FB23</b>	480664
TT (- Berl. 1.4, 1.6, 1.8, 1.9 D (-ABS))	04/97-	<b>8548</b>	<		235	 <b>FB23</b> <b>FB23</b>	480665

### XSARA PICASSO

TT	12/99-	<b>8485</b>	<>		465	 <b>FZ</b> <b>MC11</b>	480685
TT	12/99-CH:09526	<b>8561</b>	<>		255	 <b>FZ1</b> <b>FZ1</b>	480686
TT	CH:09527-	<b>80227</b>	<>		260	 <b>FB23</b> <b>FZ</b>	4806E3

### ZX

TT	03/91-06/97	<b>8547</b>	<>		460	 <b>FZ</b> <b>MC11</b>	96124230
TT	03/91-06/97	<b>8626</b>	>		240	 <b>FB23</b> <b>FB23</b>	480664

## TUBI FLESSIBILI PER FRENO



o.e.

### segue ZX

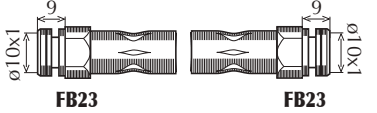
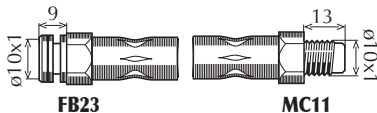
TT	03/91-06/97	8548	<	235	 <b>FB23</b> <b>FB23</b>	480665
1.6i, 1.8i, 1.9 td, 2.0i, 1.9 td SW (alla pinza) (-ABS)	03/91-06/97	80002	<>	177	 <b>FB23</b> <b>MC11</b>	480652

### CITROEN COMMERCIALI

#### C15

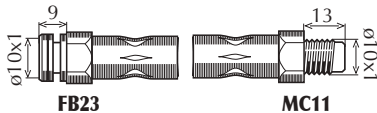
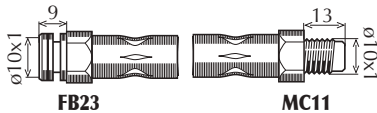
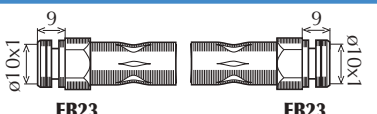
1.0, 1.1, 1.4, 1.4 E (CH: O 03978)	10/84-	8383	<>	370	 <b>FB23</b> <b>MC11</b>	91500900
TT Bz (Mot. TU, E1, G1) (CH: O04222-) 1.8 D	-12/97	8528	<>	350	 <b>FB23</b> <b>MC11</b>	91515816
TT	10/84-	8328	<>	205	 <b>FB23</b> <b>FB23</b>	481626

#### C25

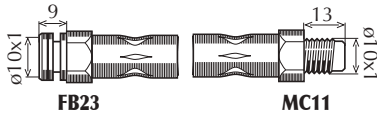
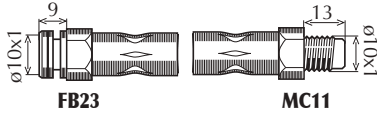
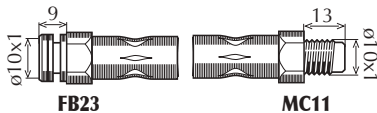
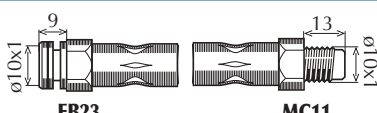
TT ->CH:171999	10/81-94	8365	<>	388	 <b>FB23</b> <b>MC11</b>	480624
TT CH:172000->	-94	8411	>	460	 <b>FB23</b> <b>MC11</b>	480635
TT CH:172000->	-94	8410	<	460	 <b>FB23</b> <b>MC11</b>	480636
TT	10/81-94	8354	<>	284	 <b>FB23</b> <b>MC11</b>	481627

### JUMPER

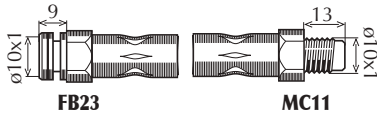
TT	02/94-	8571	<>	490	 <b>FB23</b> <b>MC11</b>	480671
----	--------	------	----	-----	---	--------

## TUBI FLESSIBILI PER FRENO



L



o.e.

### segue JUMPER

TT (-ABS)	02/94-	8531	<>	350	<p>FB23 MC11</p>	480672
TT (+ABS)	02/94-	8517	>	360	<p>FB23 MC11</p>	480673
TT (+ABS)	02/94-	8425	<	335	<p>FB23 MC11</p>	481636

### JUMPER (Mod. 2002)

TT	11/01->	80183	<>	500	<p>FB23 MC11</p>	4806F2
TT (centrale)	11/01->	80177	○	382	<p>FB23 MC11</p>	4806C8
TT	11/01->	8459	<>	182	<p>FB23 MC11</p>	4806C4

### JUMPER (Mod. 2006)

TT	07/06-	80243	<>	515	<p>FB23 MC11</p>	ND
TT	07/06-	80284	<>	440	<p>FB79 MC55</p>	ND
TT (Carreggiata maggiorata)	07/06-	80285	<>	515	<p>FB79 MC55</p>	ND

### JUMPY

TT	02/96-	8569	<>	515	<p>FZ MG1</p>	480682
----	--------	------	----	-----	---------------	--------

## TUBI FLESSIBILI PER FRENO



L



o.e.

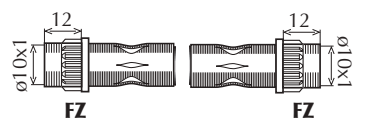
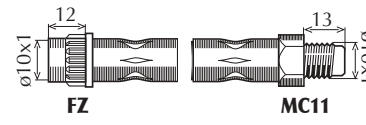

### segue JUMPY

TT	02/96-	8573	<>	275		480667
TT	02/96-	8570	<>	325		480668

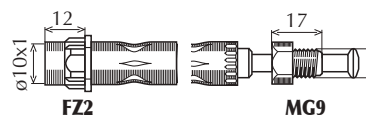
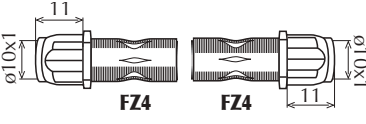
### JUMPY (Mod. 2007)

TT	01/07-	80748	<>	510		4806H0
TT	01/07-	80749	<>	265		4806H5

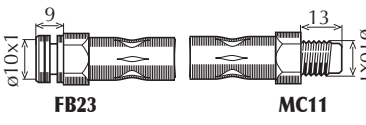
### NEMO

TT	01/08-	80188	<>	425		ND
TT	01/08-	80303	<>	195		ND



## TUBI FLESSIBILI PER FRENO

**L**

**o.e.**

### DUSTER

TT	09/04-	<b>80666</b>	<>		440		462107756R
TT	09/04-	<b>8444</b>	<>		305		6001551097

### LOGAN

TT	09/04-	<b>8443</b>	<>		330		6001551098
TT	09/04-	<b>8444</b>	<>		305		6001551097

### SANDERO

TT	06/08-	<b>8443</b>	<>		330		6001551098
TT	06/08-	<b>8444</b>	<>		305		6001551097

## TUBI FLESSIBILI PER FRENO



L



o.e.

### APPLAUSE I-II

TT	06/89-	8113	<>	485		9004922118
----	--------	------	----	-----	--	------------

### CHARADE III

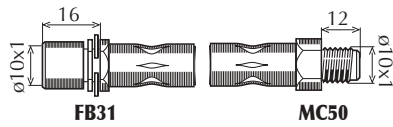
TT	03/87-02/93	8113	<>	485		9004922118
----	-------------	------	----	-----	--	------------

### CHARADE IV

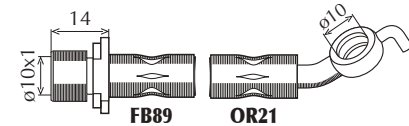
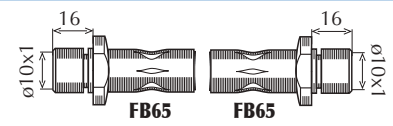
TT	01/93-	80443	<>	480		900492214600
TT	01/93-	80444	<>	310		900492214500

### CUORE (Mod.99)

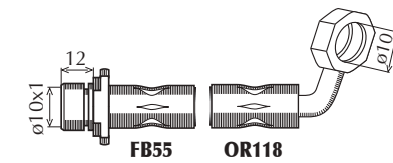
1.0	10/98-05/03	80445	<>	470		9004922174
-----	-------------	-------	----	-----	--	------------

### CUORE (Mod. 2003)

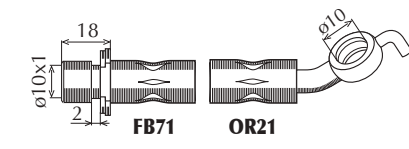
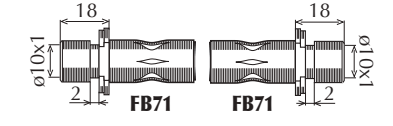
1.0	03/03-	80954	<>	500		9004922188
1.0	03/03-	80955	<>	300		9004922187

### CUORE (Mod. 2007)

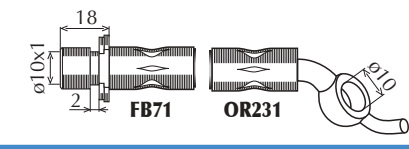
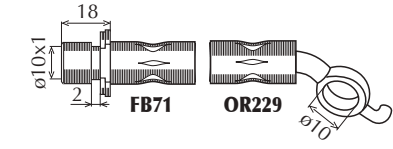
1.0	04/03-	80956	▼	430		9004922200
1.0	04/03-	80957	▲	430		9004922201

## TUBI FLESSIBILI PER FRENO

**L**

**o.e.**

### segue CUORE (Mod. 2007)

1.0	04/03-	<b>80958</b>	<>	185		9004922202
-----	--------	--------------	----	-----	--	------------

### FEROZA

1.6 16V	10/88-12/97	<b>80446</b>	<>		normale	9004922127
---------	-------------	--------------	----	--	---------	------------

### SIRION

TT	04/98-01/05	<b>80445</b>	<>	470		9004922174
----	-------------	--------------	----	-----	--	------------

### TERIOS

1.3, 1.3 4WD	10/00-10/05	<b>80447</b>	<>	495		9004922168
--------------	-------------	--------------	----	-----	--	------------

### TERIOS II

TT	11/05-	<b>80959</b>	>	555		9004922205
----	--------	--------------	---	-----	--	------------

TT	11/05-	<b>80960</b>	<	555		9004922206
----	--------	--------------	---	-----	--	------------

TT	11/05-	<b>80961</b>	>	305		9004922281
----	--------	--------------	---	-----	--	------------

TT	11/05-	<b>80962</b>	<	300		9004922207
----	--------	--------------	---	-----	--	------------

### TREVIS

1.0	07/06-	<b>80954</b>	<>	500		9004922188
-----	--------	--------------	----	-----	--	------------

## TUBI FLESSIBILI PER FRENO



L



o.e.

### segue TREVIS

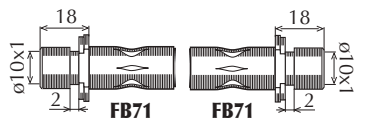
1.0	07/06-	80955	< >	300		9004922187
-----	--------	-------	-----	-----	--	------------

### YRV

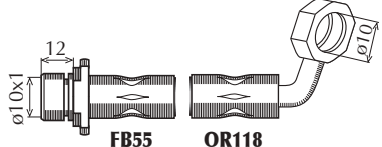
TT	02/01-	80445	< >	470		9004922174
----	--------	-------	-----	-----	--	------------

## TUBI FLESSIBILI PER FRENO



o.e.

### 124

TT	-75	8072	<>		275		4234924
TT (intermedio)	-75	8086	<>		204		4134496
TT	-75	8083	<>		175		4234923

### 125

TT	-74	8281	<>		370		4234920
TT (intermedio)	-74	8019	<>		295		4234922
TT	-74	8083	<>		175		4234923

### 126

TT	73-92	8144	<>		285		4167826
TT	73-92	8143	<>		240		4167824

### 127

#### 900, 1050

900	03/71-03/77	8266	<>		300		4253987
900	03/71-03/77	8269	<>		265		7593342

Legenda/Legend: ○ = Intermedio/Intermediate - ● = Interno/Inner - ▲ = Superiore/Upper - ▼ = Inferiore/Lower

## TUBI FLESSIBILI PER FRENO



L



o.e.

### segue 127

### segue 900, 1050

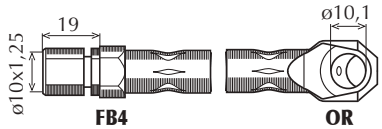
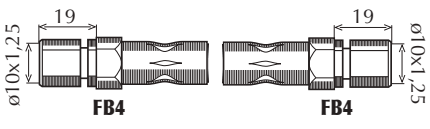
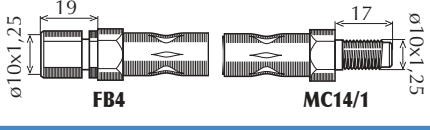
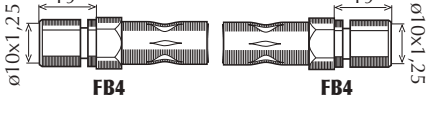
900, 1050 (->CH:8050132)	04/77-10/81	<b>8362</b>	<>		305		7593341
900, 1050 (->CH:8050132)	04/77-10/81	<b>8360</b>	<>		255		4392835
900, 1050 (III Serie) (CH:8050133->)	11/81-86	<b>8359</b>	<>		305		5966930
900, 1050 (III Serie) (CH:8050133->)	11/81-86	<b>8360</b>	<>		255		4392835

### 1050, 1300 Sport

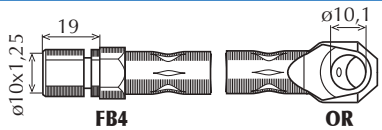
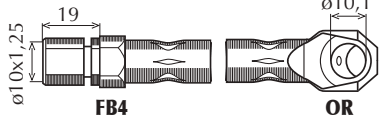
TT	06/78->83	<b>8144</b>	<>		285		4167826
TT	06/78->83	<b>8269</b>	<>		265		7953342

### Diesel, Panorama, Rustica, 147

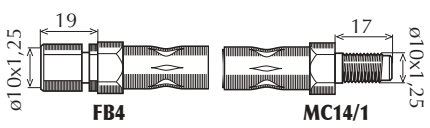
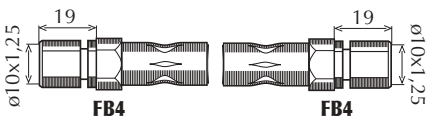
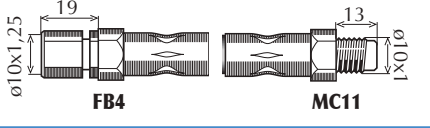
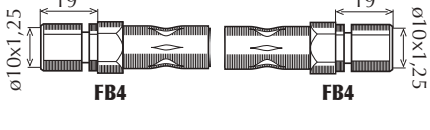
TT	79-10/82	<b>8359</b>	<>		305		5966930
TT	79-10/82	<b>8360</b>	<>		255		4392835
TT	10/82-	<b>8361</b>	<>		370		598300
TT	10/82-	<b>8360</b>	<>		255		4392835

## TUBI FLESSIBILI PER FRENO



o.e.

### 128

TT	69->84	8266	<>		300	<p>FB4 OR</p>	4253987
TT	69->84	8269	<>		265	<p>FB4 OR</p>	7593342

### 131

TT	10/74-06/82	8266	<>		300	<p>FB4 OR</p>	4253987
TT	10/74-06/82	8282	<>		305	<p>FB4 MC14</p>	4349187
TT	07/82-84	8363	<>		361	<p>FB23 MC11</p>	5966948
TT	07/82-84	8354	<>		284	<p>FB23 MC11</p>	7570315
TT (Vett. Con Check Control)	05/83-84	8355	<>		421	<p>FB23 MC11</p>	5986578



### 132

TT	10/74-06/82	8281	<>		370	<p>FB4 OR</p>	4293206
TT (intermedio)	10/74-06/82	8282	<>		305	<p>FB4 MC14</p>	4296605
TT	10/74-06/82	8083	<>		175	<p>FB4 MP6</p>	4234923

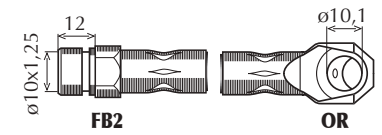

**TUBI FLESSIBILI PER FRENO**

**L**

**o.e.**
**500 - 500 D**

TT		<b>8026</b>	<>		283		4029189
TT		<b>8027</b>	<>		226		4029190

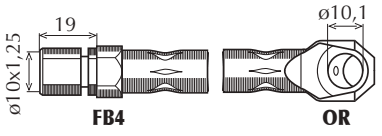
**500 F-L-R**

TT	03/65-75	<b>8144</b>	<>		285		4167826
TT	03/65-75	<b>8143</b>	<>		240		4167824

**500 (MOD. 2007)**

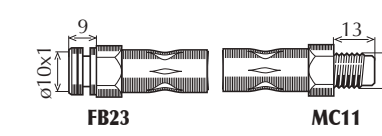
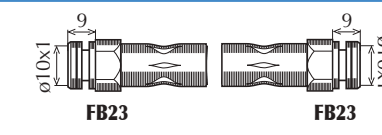
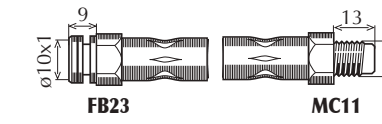
TT	07/07-	<b>80262</b>	<>		385		51800680
1.2, 13 MJTD	07/07-	<b>80174</b>	<>		188		46803893
1.4 16V	07/07-	<b>80176</b>	<>		245		46814034

**500L (09/2012->)**

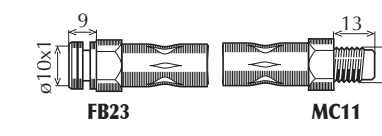
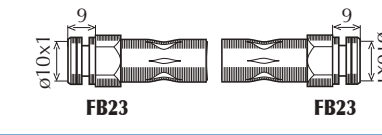
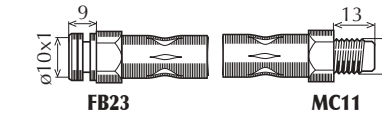
TT	09/12-	<b>80720</b>	<>				51835425
TT	09/12-	<b>81033</b>	<>		255		51882545
TT (alla pinza)	09/12-	<b>80186</b>	<>		162		55700975



## TUBI FLESSIBILI PER FRENO



L



o.e.

### 600 D-E

TT		8020	<>		310		4023587
TT		8021	<>		224		4023586

### 600 DM-T

TT		8031	<>		441		4130343
TT		8021	<>		224		4023586

### 850 Berlina

TT	04/64-03/68	8066	<>		315		4234525
TT	04/64-03/68	8067	<>		224		4104668
Super	03/68->73	8072	<>		275		4234924
Super	03/68->73	8067	<>		224		4104668

### 850 T

TT		8142	<>		432		4171159
TT		8143	<>		240		4167824

Legenda/Legend: ○ = Intermedio/Intermediate - ● = Interno/Inner - ▲ = Superiore/Upper - ▼ = Inferiore/Lower

**TUBI FLESSIBILI PER FRENO**

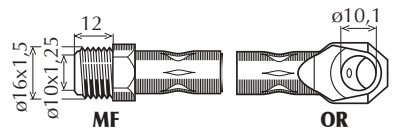
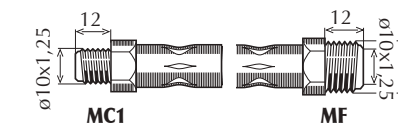
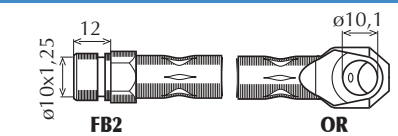
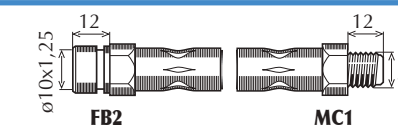
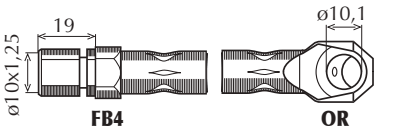
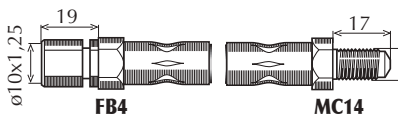
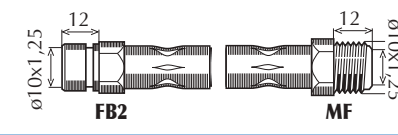
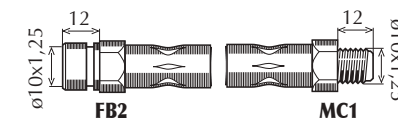
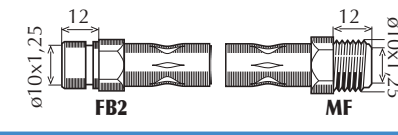
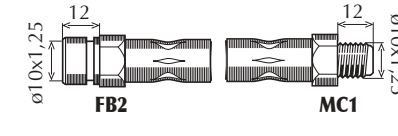
<b>1100/103</b>							
TT		8023	<>		406		4023588
TT		8003	<>		312		4023585
<b>1100 D</b>							
TT		8065	<>		406		4029285
TT		8055	<>		320		4083605
<b>1100 R</b>							
TT		8084	<>		325		4157476
TT		8138	<>		325		4170333
<b>1300 - 1500</b>							
TT		8046	<>		345		4137665
TT		8047	<>		295		4137664
<b>1800 B - 2300</b>							
TT		8054	<>		370		4102049
TT		8044	<>		312		4102047

## TUBI FLESSIBILI PER FRENO

**L**

**o.e.**

### ARGENTA

TT	04/81-04/83	8357	<>		361	<p>FB23 MC11</p>	5941315
TT	04/83-86	8358	<>		361	<p>FB23 MC11</p>	5989142
TT (Tamburo)	04/81-86	8354	<>		284	<p>FB23 MC11</p>	4477793
TT (Disco)	04/81-86	8429	<>		157	<p>FB23 MC11</p>	7563844

### BARCETTA

1.8 16V	94-	8560	<>		425	<p>FB23 MC11</p>	46423179
1.8 16V	94-	8427	<>		217	<p>FB23 FB23</p>	7563852
1.8 16V (alla pinza)	94-	8459	<>		182	<p>FB23 MC11</p>	7586907

### BRAVA - BRAVO

#### 1.2, 1.4, 1.6, 1.9 D, 1.9 TD, 1.9 JTD

TT	06/95-10/01	8552	<>		415	<p>FB23 MC11</p>	46448591
TT	06/95-10/01	8417	<>		240	<p>FB23 FB23</p>	7667806

### 1.8

TT	06/95-10/01	8552	<>		415	<p>FB23 MC11</p>	46448591
----	-------------	------	----	--	-----	------------------	----------

**TUBI FLESSIBILI PER FRENO**

**o.e.**
**segue BRAVA - BRAVO**
**segue 1.8**

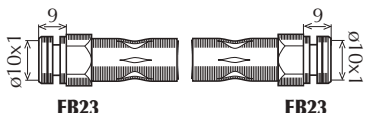
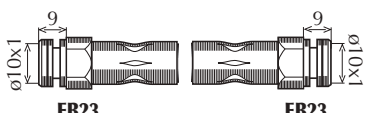
TT	06/95-09/97	<b>8486</b>	<>	245	 <b>FB23</b>	7670215
TT	10/97-10/01	<b>8417</b>	<>	240	 <b>FB23</b>	7667806

**2.0**

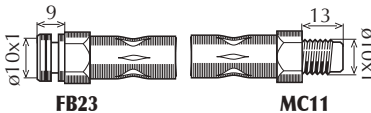
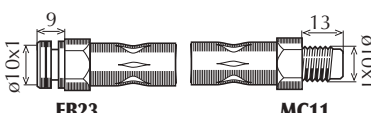
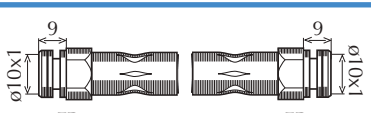
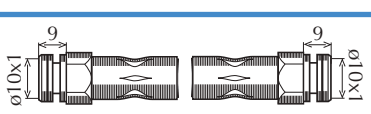
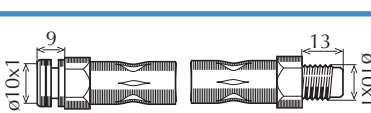
TT	06/95-09/97	<b>8553</b>	<>	435	 <b>FB23</b> <b>MC11</b>	46448593
TT	10/97-10/01	<b>8554</b>	<>	435	 <b>FB23</b> <b>MC11</b>	46454003
TT (intermedio)	06/95-09/97	<b>8486</b>	<>	245	 <b>FB23</b>	7670215
TT (intermedio)	10/97-10/01	<b>8417</b>	<>	240	 <b>FB23</b>	7667806
TT	06/95-10/01	<b>8459</b>	<>	182	 <b>FB23</b> <b>MC11</b>	7586907

**BRAVO (Mod. 2007)**

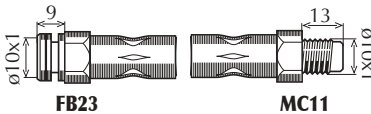
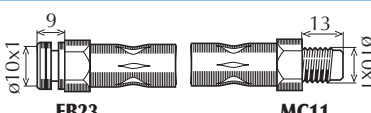
TT	04/07-	<b>8917</b>	<>	435	 <b>FB23</b> <b>MC11</b>	46554126
TT	04/07-	<b>80335</b>	<>	210	 <b>FB23</b> <b>MC11</b>	51783802

**CINQUECENTO**

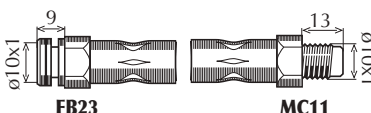
0.7, 0.9	07/91-01/98	<b>8447</b>	<>	470	 <b>FB23</b> <b>MC11</b>	7635376
----------	-------------	-------------	----	-----	---	---------

## TUBI FLESSIBILI PER FRENO



L



o.e.

### segue CINQUECENTO

1.1	10/94-01/98	8564	<>		470	<p>FB23 MC11</p>	46481635
TT	07/91-01/98	8448	<>		293	<p>FB23 FB23</p>	7635376

### COUPE'

TT	93-96	8436	<>		435	<p>FB23 MC11</p>	7729198
TT	96-	8696	<>		410	<p>FB23 MC11</p>	4646099
TT (intermedio)	93-96	8417	<>		240	<p>FB23 FB23</p>	7667806
TT	93-96	8459	<>		182	<p>FB23 MC11</p>	7586907

### CROMA

TT	10/85-10/92	8400	<>		582	<p>FB23 MC11</p>	82422141
TT	10/92-12/96	8572	<>		560	<p>FB23 MC11</p>	82473716
TT (- ABS)	10/85-12/96	8401	<>		407	<p>FB23 MC11</p>	82422142
TT (+ABS)	10/85-12/96	8066	<>		315	<p>FB4 OR</p>	82422144

**TUBI FLESSIBILI PER FRENO**

**L**

**o.e.**
**CROMA (Mod.2005)**

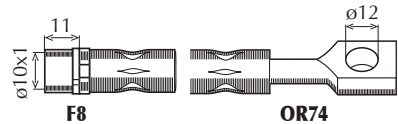
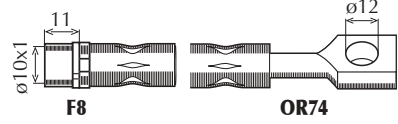
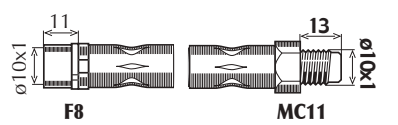
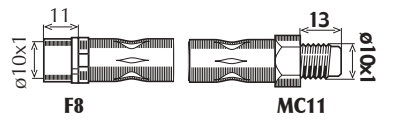
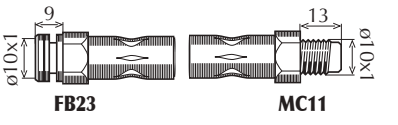
1.8, 2.2, 1.9 JTD (115,120 CV)	06/05-	<b>80340</b>	<>		425	 <b>F8</b> <b>OR74</b>	51759919
1.9 JTD (150 CV)	10/06-	<b>80340</b>	<>		425	 <b>F8</b> <b>OR74</b>	51759919
1.9 JTD (150 CV)	06/05-09/06	<b>80644</b>	<>		405	 <b>F8</b> <b>MC11</b>	51757836
2.4 JTD	06/05-	<b>80644</b>	<>		405	 <b>F8</b> <b>MC11</b>	51757836
TT	06/05-	<b>80181</b>	<>		320	 <b>FB23</b> <b>MC11</b>	51733731

**DOBLO'**
**(->2005)**

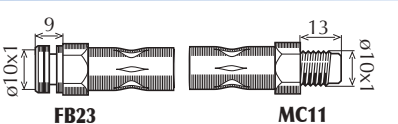
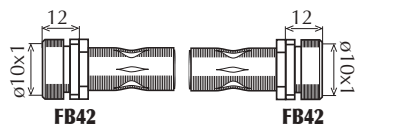
TT	2001-09/05	<b>8915</b>	<>		500	 <b>FB23</b> <b>MC11</b>	46738613
TT	2001-09/05	<b>8916</b>	<>		465	 <b>FB42</b> <b>FB42</b>	46749271

**(RETTY 2005)**

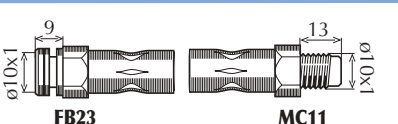
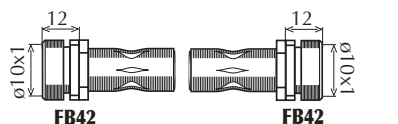
TT	10/05-	<b>80448</b>	<>		515	 <b>FB23</b> <b>MC11</b>	51776519
TT	10/05-	<b>8916</b>	<>		465	 <b>FB42</b> <b>FB42</b>	46749271

**DOBLO' (Mod.2010)**

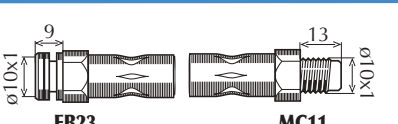
TT	01/10-	<b>80963</b>	<>		435	 <b>FB23</b> <b>MC11</b>	51814431
----	--------	--------------	----	--	-----	---	----------

## TUBI FLESSIBILI PER FRENO



L



o.e.

### segue DOBLO' (Mod.2010)

TT	01/10-	80964	<>	220	 <p>FB23      FB23</p>	51810448
----	--------	-------	----	-----	--	----------

### DUNA

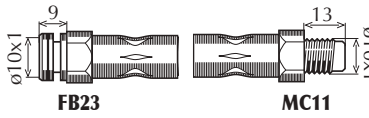
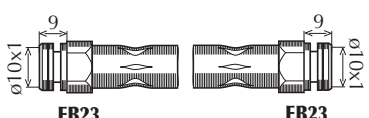
TT	90-	8405	<>	390	 <p>FB23      MC11</p>	5995681
TT	90-	8406	<>	280	 <p>FB23      FB23</p>	7573858

### FREEMONT

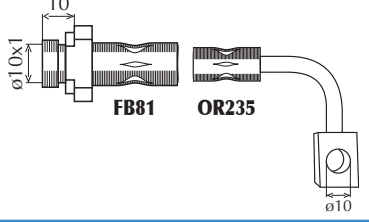
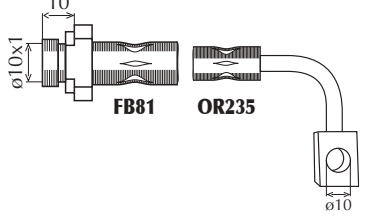
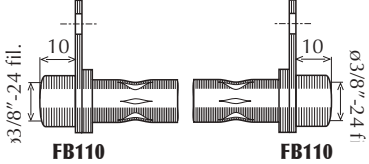
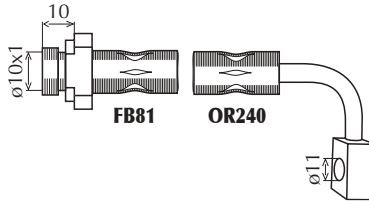
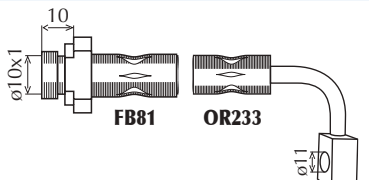
TT	08/11-	81015	▼	500	 <p>FB81      OR235</p>	K04862210AC
TT	08/11-	81016	▲	500	 <p>FB81      OR235</p>	K04862211AC
TT (centrale)	08/11-	81017	○	260	 <p>FB110      FB110</p>	K04766559AA
TT	08/11-	81018	▼	275	 <p>FB81      OR240</p>	K04862212AD
TT	08/11-	81019	▲	275	 <p>FB81      OR233</p>	K04862213AE

Legenda/Legend: ○ = Intermedio/Intermediate - ● = Interno/Inner - ▲ = Superiore/Upper - ▼ = Inferiore/Lower

**TUBI FLESSIBILI PER FRENO**

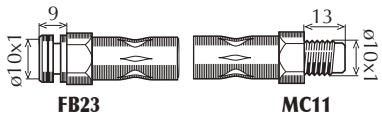
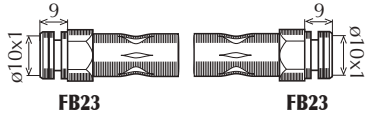
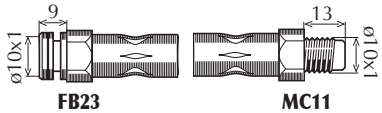
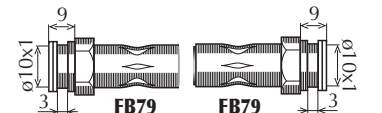
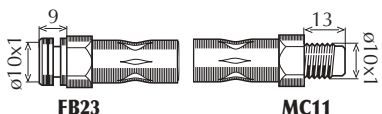
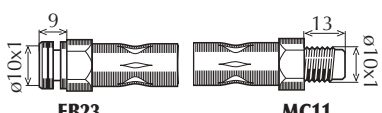
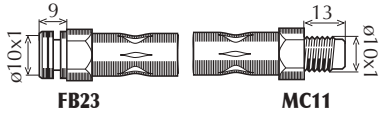
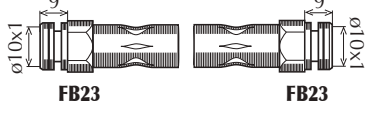
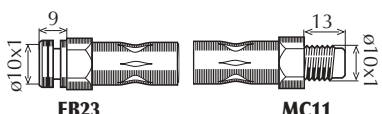
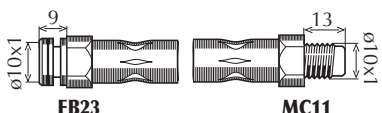
<b>IDEA</b>							
TT	01/04-	<b>80184</b>	<>		476	 <b>FB23</b> <b>MC11</b>	51767150
TT	01/04-	<b>8265</b>	<>		195	 <b>FB23</b> <b>FB23</b>	46542040
<b>LINEA</b>							
TT	06/07-	<b>80188</b>	<>		425	 <b>FB23</b> <b>MC11</b>	55701047
1.4, 1.3 JTD	06/07-	<b>80303</b>	<>		195	 <b>FB79</b> <b>FB79</b>	51790084
1.4 T-JET	09/07-	<b>80176</b>	<>		245	 <b>FB23</b> <b>MC11</b>	46814034
<b>MAREA</b>							
TT BZ (-2.0 20V) , 1.9 TD, 1.9 JTD	07/96-	<b>8554</b>	<>		435	 <b>FB23</b> <b>MC11</b>	46454003
2.0 20V, 2.4 TD, 2.4 JTD	07/96-	<b>8696</b>	<>		410	 <b>FB23</b> <b>MC11</b>	46460699
TT	07/96-	<b>8417</b>	<>		240	 <b>FB23</b> <b>FB23</b>	7667806
2.0 20V, 2.4 TD, 2.4 JTD (alla pinza)	07/96-	<b>8459</b>	<>		182	 <b>FB23</b> <b>MC11</b>	7586907
<b>MULTIPLA</b>							
1.6, 1.9 JTD	12/98-	<b>8562</b>	<>		460	 <b>FB23</b> <b>MC11</b>	46556045



## TUBI FLESSIBILI PER FRENO



L



o.e.

### segue MULTIPLA

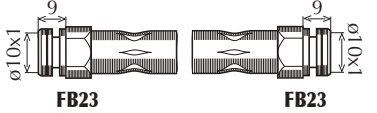
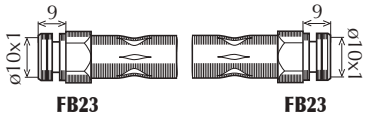
1.6, 1.9 JTD (intermedio)	12/98-	<b>8427</b>	<>	217	 <p><b>FB23</b>      <b>FB23</b></p>	7603330
1.6, 1.9 JTD	12/98-	<b>8417</b>	<>	240	 <p><b>FB23</b>      <b>FB23</b></p>	7667806

### PALIO

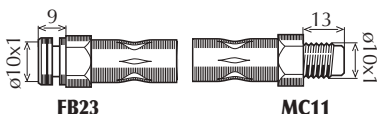
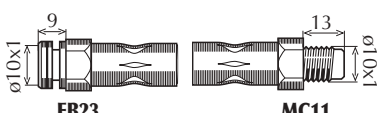
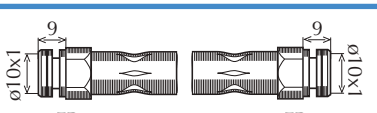
TT	04/96-	<b>8606</b>	<>	485	 <p><b>FB23</b>      <b>MC11</b></p>	46448474
TT (intermedio)	04/96-	<b>8611</b>	<>	245	 <p><b>FB23</b>      <b>MC11</b></p>	82442878
TT	04/96-	<b>8613</b>	<>	255	 <p><b>FB23</b>      <b>FB23</b></p>	46556013

### PANDA

#### 30, 45 (->10/85)

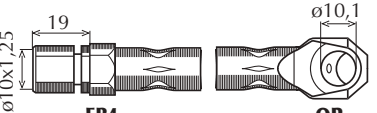
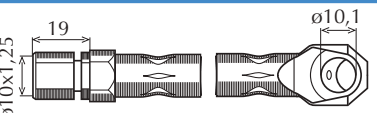
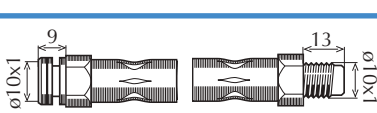
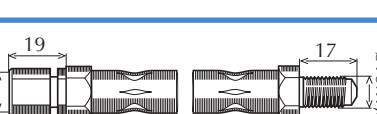
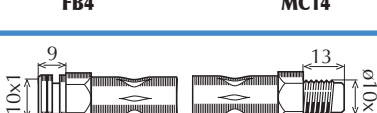
TT (-CH:6109134)	80-	<b>8320</b>	<>	300	 <p><b>FB4</b>      <b>OR</b></p>	82422135
TT (CH:6109135-)	-09/82	<b>8314</b>	<>	268	 <p><b>FB4</b>      <b>OR</b></p>	4464149
TT	10/82-10/85	<b>8353</b>	<>	463	 <p><b>FB23</b>      <b>MC11</b></p>	7569595
TT	-09/82	<b>8315</b>	<>	345	 <p><b>FB4</b>      <b>MC14</b></p>	4426826
TT	10/82-10/85	<b>8354</b>	<>	284	 <p><b>FB23</b>      <b>MC11</b></p>	7570315

Legenda/Legend: ○ = Intermedio/Intermediate - ● = Interno/Inner - ▲ = Superiore/Upper - ▼ = Inferiore/Lower

**TUBI FLESSIBILI PER FRENO**

**o.e.**
**segue PANDA**
**750, 903, 1000 (11/85->)**

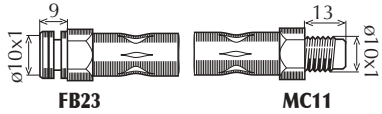
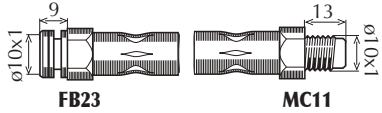
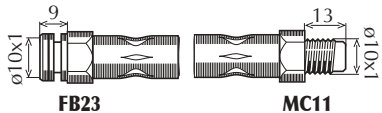
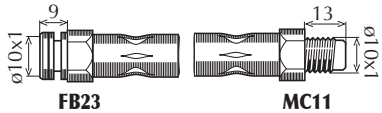
TT	11/85-03/91	<b>8426</b>	<>		408		7598927
TT	04/91-	<b>8424</b>	<>		407		7563601
TT	11/85-03/91	<b>8382</b>	<>	<>	210		7563845
TT	04/91-	<b>8489</b>	<>	<>	210		7593353

**1.3 Diesel**

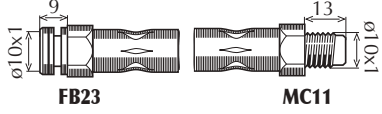
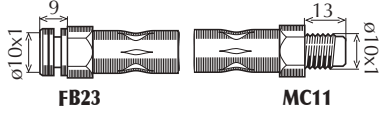
TT	11/85-03/91	<b>8426</b>	<>		408		7598927
TT	11/85-03/91	<b>8382</b>	<>	<>	210		7563845

**Selecta**

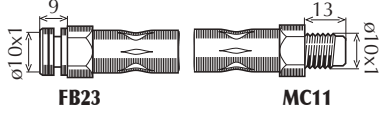
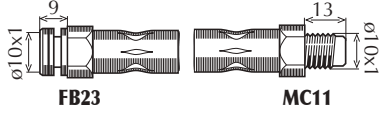
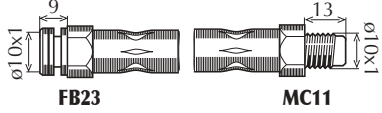
TT	90-01/93	<b>8413</b>	<>		460		7706229
TT	01/93-	<b>8424</b>	<>		407		7563601
TT	90-	<b>8489</b>	<>	<>	210		7593353

**4x4**

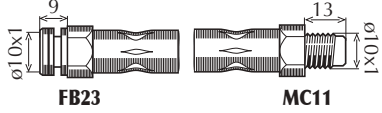
TT	07/83-	<b>8424</b>	<>		407		7563601
----	--------	-------------	----	--	-----	--	---------

## TUBI FLESSIBILI PER FRENO



L



o.e.

### segue PANDA

#### segue 4x4

TT	07/83-	8425	<>	335		7569593
----	--------	------	----	-----	--	---------

### PANDA (MOD. 2003)

TT	09/03-	80180	<>	465		51718921
TT	09/03-	80174	<>	188		46803893

### CROSS - CLIMBING - TREKKING 4X4

TT	10/04-	80182	<>	495		51745709
TT (Tamburo)	10/04-	80174	<>	188		46803893
TT (disco)	10/04-	80176	<>	245		46814034

### Panda (Mod.2012)

TT	02/12-	80262	<>	385		51800680
TT	02/12-	80174	<>	188		46803893





### PUNTO

#### 1.1, 1.2, 1.6, 1.7 DS (- ABS)

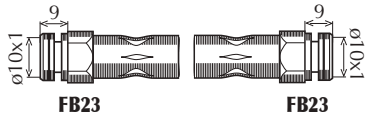

TT	09/93-09/99	8481	<>	385		7735009
----	-------------	------	----	-----	--	---------

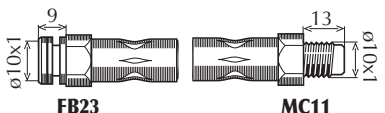
**TUBI FLESSIBILI PER FRENO**

**o.e.**
**segue PUNTO**
**segue 1.1, 1.2, 1.6, 1.7 DS ( - ABS)**

TT	09/93-09/99	<b>8427</b>	<>	217	 <b>FB23</b>	7563852
TT ( + Segnalatore d'usura)	09/93-09/99	<b>8559</b>	▼	385	 <b>FB23</b> <b>MC11</b>	46423177
TT ( + Segnalatore d'usura)	09/93-09/99	<b>8482</b>	▲	385	 <b>FB23</b> <b>MC11</b>	7735008
TT ( + Segnalatore d'usura)	09/93-09/99	<b>8427</b>	<>	217	 <b>FB23</b>	7563852

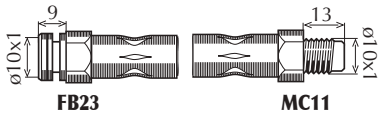
**1.1, 1.2, 1.6, 1.7 DS ( + ABS)**

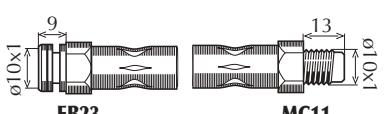
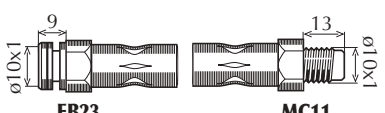
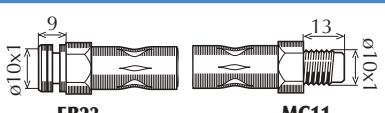
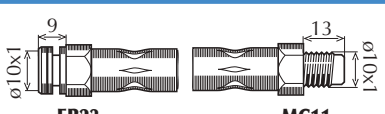
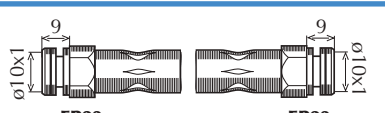
TT	09/93-02/96	<b>8483</b>	▼	420	 <b>FB23</b> <b>MC11</b>	7735011
TT	09/93-02/96	<b>8484</b>	▲	410	 <b>FB23</b> <b>MC11</b>	7735010
1.1, 1.2, 1.6, 1.7 DS	03/96-09/99	<b>8559</b>	▼	385	 <b>FB23</b> <b>MC11</b>	46423177
1.1, 1.2, 1.6, 1.7 DS	03/96-09/99	<b>8482</b>	▲	385	 <b>FB23</b> <b>MC11</b>	7735008
1.7 TD	03/96-09/99	<b>8483</b>	▼	420	 <b>FB23</b> <b>MC11</b>	7735011
1.7 TD	03/96-09/99	<b>8484</b>	▲	410	 <b>FB23</b> <b>MC11</b>	7735010
TT	09/93-09/99	<b>8427</b>	<>	217	 <b>FB23</b>	7563852

## TUBI FLESSIBILI PER FRENO



o.e.

### segue PUNTO

#### 1.2 16V

(-ABS)	97->09/99	<b>8560</b>	<>		425		46423179
(+ ABS)	97->09/99	<b>8483</b>	▼		420		7735011
(+ ABS)	97->09/99	<b>8484</b>	▲		410		7735010
TT	97->09/99	<b>8427</b>		<>	217		7563852

#### 1.2 Selecta, 1.6

1.2 Selecta, 1.6	09/93-09/99	<b>8483</b>	▼		420		7735011
1.2 Selecta, 1.6	09/93-09/99	<b>8484</b>	▲		410		7735010
1.2 Selecta, 1.6	09/93-09/99	<b>8427</b>		<>	217		7563852

#### 1.4 GT Turbo

1.4 GT Turbo	09/93-09/99	<b>8483</b>	▼		420		7735011
1.4 GT Turbo	09/93-09/99	<b>8484</b>	▲		410		7735010
1.4 GT Turbo (intermedio)	09/93-09/99	<b>8427</b>		<>	217		7563852
1.4 GT Turbo (alla pinza)	09/93-09/99	<b>8459</b>		<>	182		7586907

Legenda/Legend: ○ = Intermedio/Intermediate - ● = Interno/Inner - ▲ = Superiore/Upper - ▼ = Inferiore/Lower

**TUBI FLESSIBILI PER FRENO**

**L**

**o.e.**
**PUNTO II SERIE**

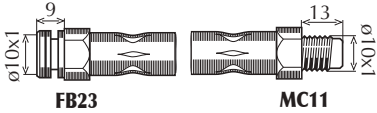
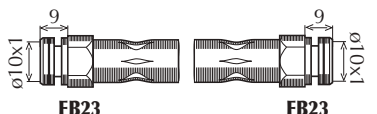
TT	09/99->	<b>8264</b>	<>		480	 <b>FB23</b> <b>MC11</b>	46760308
TT	09/99->	<b>8265</b>	<>		195	 <b>FB23</b> <b>FB23</b>	46542040

**PUNTO (Mod 2005 - Grande Punto)**

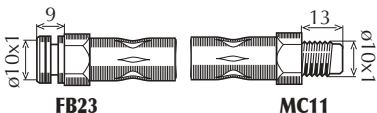
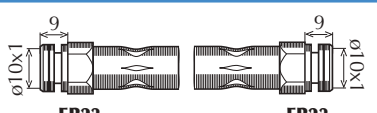
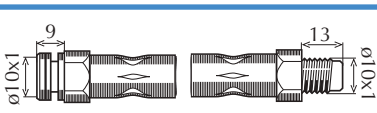
TT	10/05-	<b>80188</b>	<>		425	 <b>FB23</b> <b>MC11</b>	55701047
TT	10/05-	<b>80187</b>	<>		235	 <b>FB23</b> <b>FB23</b>	55701046
TT (disco) (alla pinza)	10/05-	<b>80186</b>	<>		162	 <b>FB23</b> <b>MC11</b>	55700975

**PUNTO Evo**

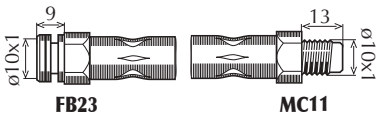
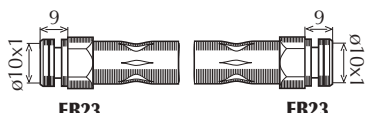
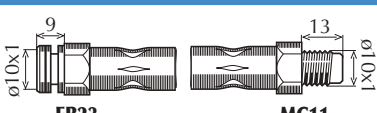
TT	07/08-	<b>80720</b>	<>		425	 <b>FB23</b> <b>MC11</b>	51835425
TT	07/08-	<b>80187</b>	<>		235	 <b>FB23</b> <b>FB23</b>	55701046
TT (disco)	07/08-	<b>80186</b>	<>		162	 <b>FB23</b> <b>MC11</b>	55700975

**Punto MY2012 (03/2012->)**

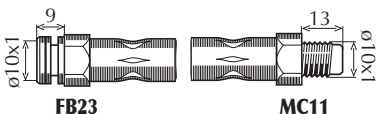
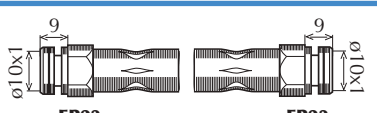
TT	03/12-	<b>80720</b>	<>			 <b>FB23</b> <b>MC11</b>	51835425
TT	03/12-	<b>80187</b>	<>		235	 <b>FB23</b> <b>FB23</b>	55701046

## TUBI FLESSIBILI PER FRENO



**o.e.**

### segue Punto MY2012 (03/2012->)

TT (alla pinza)	03/12-	<b>80186</b>	<>	162	<p><b>FB23</b>      <b>MC11</b></p>	55700975
-----------------	--------	--------------	----	-----	-------------------------------------	----------

### QUBO

TT	02/08-	<b>80188</b>	<>	425	<p><b>FB23</b>      <b>MC11</b></p>	55701047
TT	02/08-	<b>80303</b>	<>	195	<p><b>FB79</b>      <b>FB79</b></p>	51790084

### REGATA

TT	09/83-03/86	<b>8355</b>	<>	421	<p><b>FB23</b>      <b>MC11</b></p>	5986578
TT	04/86-89	<b>8416</b>	<>	305	<p><b>FB23</b>      <b>MC11</b></p>	7603316
TT	09/83-03/86	<b>8356</b>	<>	285	<p><b>FB23</b>      <b>OR</b></p>	5954071
TT	04/86-89	<b>8414</b>	<>	285	<p><b>FB23</b>      <b>OR</b></p>	7563854

### RITMO

(->10/82)

1.1	05/78-10/82	<b>8367</b>	<>	320	<p><b>FB4</b>      <b>OR</b></p>	4471492
1.1	05/78-10/82	<b>8144</b>	<>	285	<p><b>FB4</b>      <b>OR</b></p>	4167826
1.3	05/78-10/82	<b>8266</b>	<>	300	<p><b>FB4</b>      <b>OR</b></p>	4253987

Legenda/Legend: ○ = Intermedio/Intermediate - ● = Interno/Inner - ▲ = Superiore/Upper - ▼ = Inferiore/Lower



**TUBI FLESSIBILI PER FRENO**

**L**

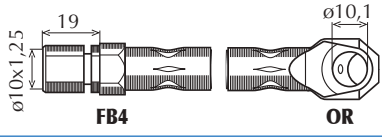
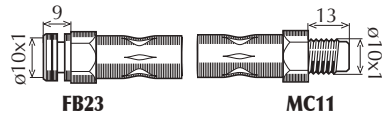

**o.e.**
**segue RITMO**
**segue (->10/82)**

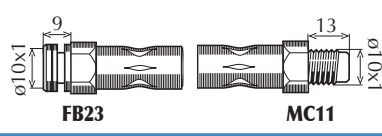
1.3	05/78-10/82	<b>8314</b>	<>	268		4464149
1.5, 105 TC	05/78-10/82	<b>8352</b>	<>	436		7569161

**II SERIE (11/82->)**

TT	11/82-03/85	<b>8355</b>	<>	421		5986578
TT	11/82-03/85	<b>8356</b>	<>	285		5954071

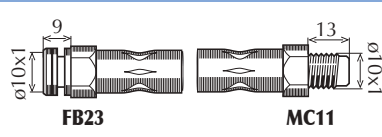
**FL 85 (04/85->)**

TT	04/85->88	<b>8405</b>	<>	390		5995681
TT	04/85->88	<b>8356</b>	<>	285		5954071

**SEDICI**

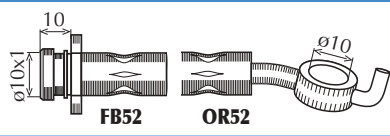
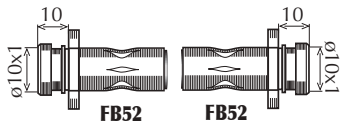
TT	06/06-	<b>80449</b>	<>	405		71742814
TT	06/06-	<b>80298</b>	<>	325		71742815

**SEICENTO**

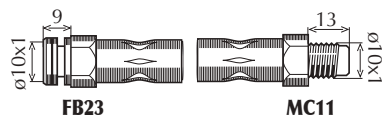
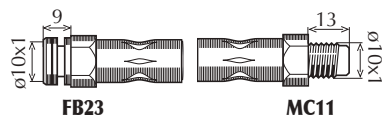
TT ( - Sporting)	01/98-	<b>8563</b>	<>	470		46481634
Sporting	01/98-	<b>8564</b>	<>	470		46481635



## TUBI FLESSIBILI PER FRENO



**L**

**o.e.**

### segue SEICENTO

TT	01/98-	<b>8448</b>	<>	293	 <b>FB23</b>	7635376
----	--------	-------------	----	-----	---	---------

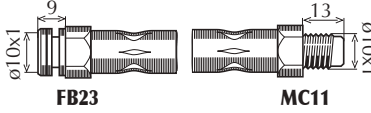
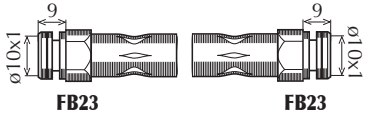
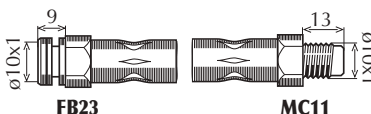
### STILO

TT	01-	<b>8917</b>	<>	435	 <b>FB23</b>	46784455
TT (intermedio)	01-	<b>8919</b>	<>	305	 <b>FB23</b>	46809897
TT (alla pinza)	01-	<b>8918</b>	<>	210	 <b>FB23</b>	46809898

### TEMPRA

(-&gt;02/93)

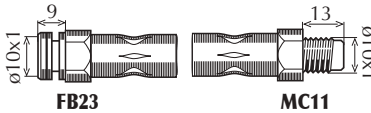
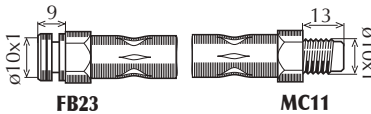
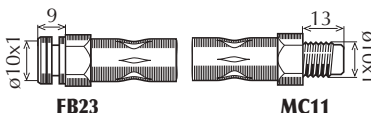
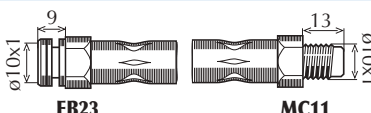
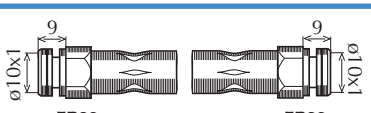
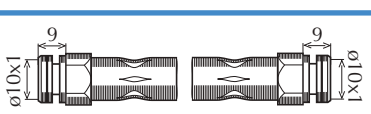
1.4, 1.6 Berlina (- ABS)	03/90-02/93	<b>8403</b>	<>	390	 <b>FB23</b>	7655155
1.4, 1.6 SW (- ABS) , 1.4, 1.6 TT (+ ABS)	03/90-02/93	<b>8415</b>	<>	405	 <b>FB23</b>	7655156
1.8, 1.9 D, 1.9 TD TT	03/90-02/93	<b>8415</b>	<>	405	 <b>FB23</b>	7655156
2.0 TT (- ABS)	03/90-02/93	<b>8433</b>	<>	407	 <b>FB23</b>	82468102
TT (- ABS)	03/90-02/93	<b>8417</b>	<>	240	 <b>FB23</b>	7667806
TT (+ ABS) (intermedio)	03/90-02/93	<b>8417</b>	<>	240	 <b>FB23</b>	7667806

Legenda/Legend: ○ = Intermedio/Intermediate - ● = Interno/Inner - ▲ = Superiore/Upper - ▼ = Inferiore/Lower

**TUBI FLESSIBILI PER FRENO**

**L**

**o.e.**
**segue TEMPRA**
**segue (->02/93)**

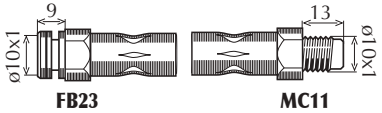
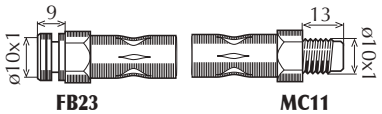
TT (- 2.0) (+ ABS)	03/90-02/93	<b>8459</b>	<>	182		7586907
2.0 TT (+ ABS)	03/90-02/93	<b>8382</b>	<>	210		7563845

**(03/93->)**

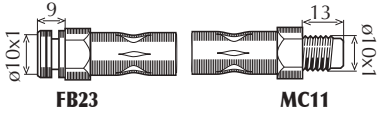
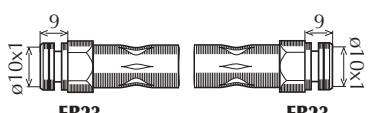
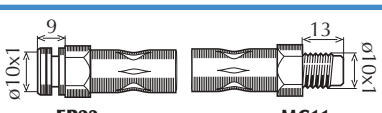
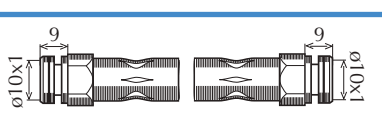
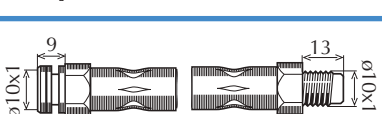
TT (-ABS)	03/93-08/97	<b>8415</b>	<>	405		7655156
TT (-ABS)	03/93-08/97	<b>8417</b>	<>	240		7667806
TT (+ABS)	03/93-08/97	<b>8415</b>	<>	405		7655156
TT (+ABS) (intermedio)	03/93-08/97	<b>8486</b>	<>	245		7670215
TT (+ABS)	03/93-08/97	<b>8459</b>	<>	182		7586907

**TIPO**
**(->02/93) (-ABS)**

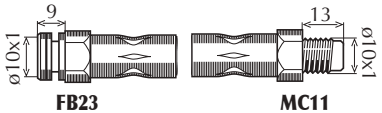
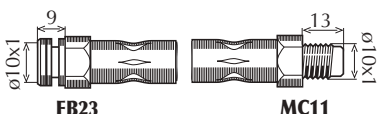
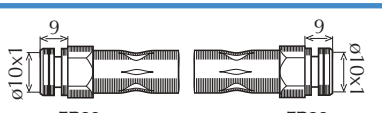
1.1,1.4,1.6,1.7 D,1.9D	02/88-02/93	<b>8403</b>	<>	390		7655155
1.6 Selecta, 1.8, 1.8 16V, 2.0, 1.9 TD	02/88-02/93	<b>8415</b>	<>	405		7655156
1.1, 1.4, 1.6	02/88-02/93	<b>8404</b>	<>	250		7619751

## TUBI FLESSIBILI PER FRENO



L



o.e.

### segue TIPO

#### segue (->02/93) (-ABS)

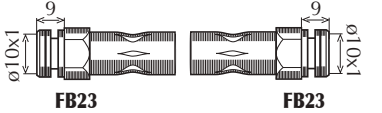
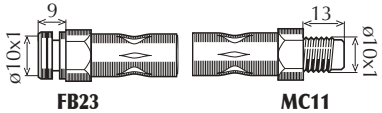
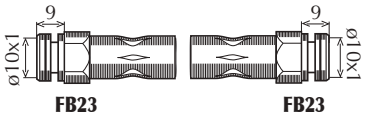
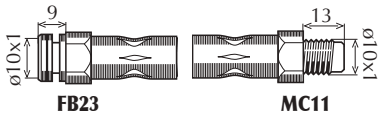
1.8, 2.0, 1.7 D, 1.9 D, 1.9 TD	02/88-02/93	<b>8417</b>	<>	240		7667806
1.8 16V, 2.0 16V	02/88-02/93	<b>8433</b>	<>	407		82468102
1.8 16V, 2.0 16V (intermedio)	02/88-02/93	<b>8417</b>	<>	240		7667806
1.8 16V, 2.0 16V (alla pinza)	02/88-02/93	<b>8459</b>	<>	182		7586907

#### (->02/93) (+ABS)

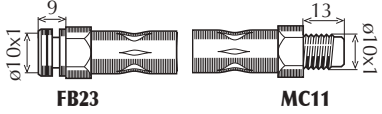
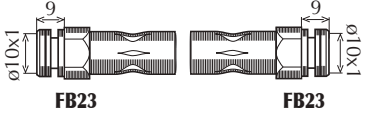
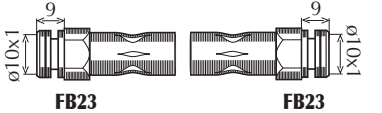
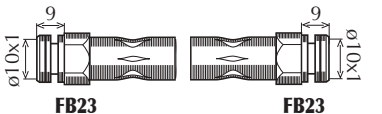
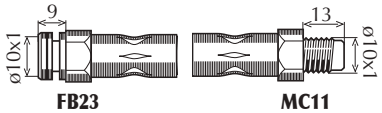
TT	02/88-02/93	<b>8415</b>	<>	405		7655156
1.1, 1.4, 1.6 (+ ABS) (intermedio)	02/88-02/93	<b>8404</b>	<>	250		7619751
1.8, 1.8 16V, 2.0, 2.0 16V, 1.7 D, 1.9 D (intermedio)	02/88-02/93	<b>8417</b>	<>	240		7667806
1.9 TD (+ ABS) (intermedio)	02/88-02/93	<b>8486</b>	<>	245		7670215
TT (alla pinza)	02/88-02/93	<b>8459</b>	<>	182		7586907

#### (03/93->)

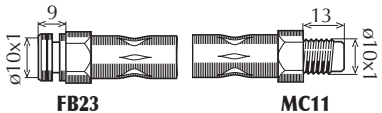
TT (- ABS)	03/93-04/95	<b>8415</b>	<>	405		7655156
------------	-------------	-------------	----	-----	--	---------

**TUBI FLESSIBILI PER FRENO**

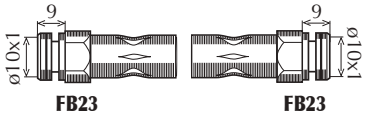
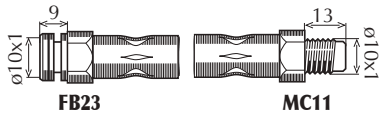
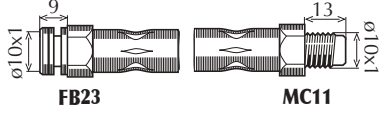
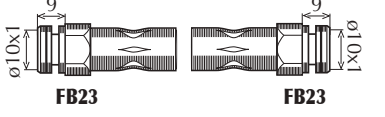
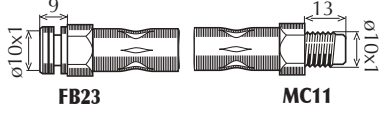

**o.e.**
**segue TIPO**
**segue (03/93->)**

TT (- ABS)	03/93-04/95	<b>8417</b>	<>	240		7667806
TT (- 2.0 16V) (+ ABS)	03/93-04/95	<b>8415</b>	<>	405		7655156
2.0 16V (+ABS)	03/93-04/95	<b>8433</b>	<>	407		82468102
TT (+ ABS) (intermedio)	03/93-04/95	<b>8486</b>	<>	245		7670215
TT (+ ABS) (alla pinza)	03/93-04/95	<b>8459</b>	<>	182		7586907

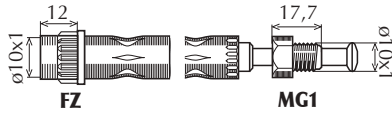
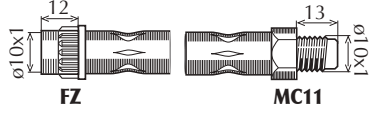
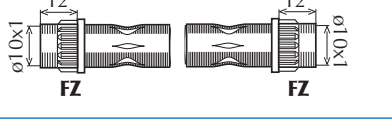
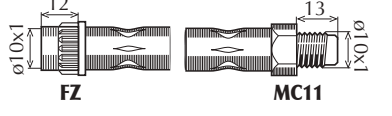
**ULYSSE**

TT	94-05/97	<b>8569</b>	<>	515		1479197080
TT	06/97-08/02	<b>80159</b>	<>	450		1489794080
TT (intermedio)	94-08/02	<b>8573</b>	○	275		1472157080
TT	94-08/02	<b>8570</b>	<>	325		1472155080

**ULYSSE II SERIE**

TT (- 3.0 V6)	09/02-	<b>80007</b>	<>	490		1484536080
TT	09/02-	<b>8573</b>	<>	275		1472157080

**Legenda/Legend: ○ = Intermedio/Intermediate - ● = Interno/Inner - ▲ = Superiore/Upper - ▼ = Inferiore/Lower**

## TUBI FLESSIBILI PER FRENO



L



o.e.

### UNO

(->12/85)

45, 55, 70 (- Check Control) (- CH: 0261487)	-12/85	<b>8350</b>	<>		436		5966685
45, 55, 70 (- Check Control) (- CH: 0261487)	-12/85	<b>8351</b>	<>		218		5944002
45, 55, 70 (+ Check Control) (- CH: 0261487)	-12/85	<b>8352</b>	<>		436		7569161
45, 55, 70 (+ Check Control) (- CH: 0261487)	-12/85	<b>8427</b>	<>		217		7563852
1.3 Diesel (-> CH: 0261487)	-12/85	<b>8352</b>	<>		436		7569161
1.3 Diesel (-> CH: 0261487)	-12/85	<b>8351</b>	<>		218		5944002

(01/86->07/89)

45, 55, 70, 1.3 Diesel (CH: 0261488-)	01/86-07/89	<b>8352</b>	<>		436		7569161
45, 55, 70, 1.3 Diesel (CH: 0261488-)	01/86-07/89	<b>8427</b>	<>		217		7563852

Restyling (08/89->)

45, 60	08/89-	<b>8381</b>	<>		410		7563848
1.4 ie, 1.5 ie, 1.3 Diesel	08/89-	<b>8407</b>	<>		410		7569160

## TUBI FLESSIBILI PER FRENO



L



o.e.

### segue UNO

#### segue Restyling (08/89->)

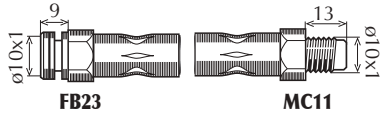
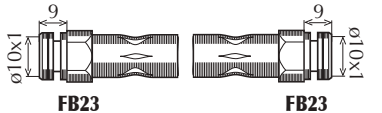
1.4 ie/1.5ie (Selecta), 1.4 TD, 1.7 Diesel	08/89-	<b>8428</b>	<>		460		7577467
TT	08/89-	<b>8427</b>	<>		217		7563852

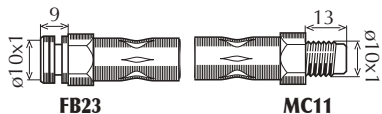
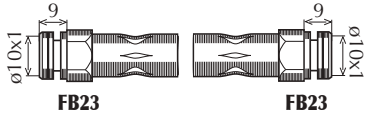
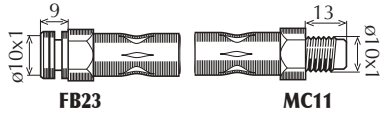

### 1.4 ie Turbo

1.4 ie Turbo	06/85-	<b>8428</b>	<>		460		7577467
1.4 ie Turbo (intermedio)	06/85-	<b>8427</b>		○	217		7563852
1.4 ie Turbo	06/85-	<b>8429</b>	<>		157		7563844

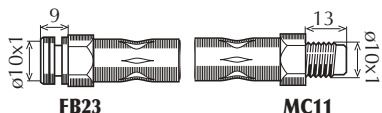
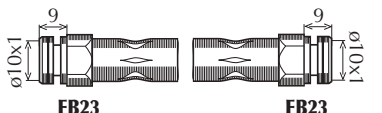
### UNO CS

TT		<b>8405</b>	<>		390		5995681
TT		<b>8406</b>	<>		280		7573858

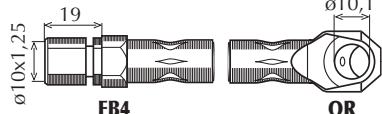
### X 1/9

TT		<b>8016</b>	<>		240		4428541
TT		<b>8017</b>	<>		250		5937834

## TUBI FLESSIBILI PER FRENO



o.e.

### FIAT COMMERCIALI

#### 238 (Circuito Semplice)

238	-02/80	8084	<>		325		4157476
238	03/80-	8316	<>		315		4303019
238		8086	<>	<>	204		4134496

#### 238 (Circuito Doppio)

238	01/81-	8367	<>		320		4471492
238		8143	<>	<>	240		4167824

### 241

241 T - TN		8136	<>		405		4235485
241 T		8019	<>	<>	295		4234922
241 TN		8268	<>	<>	265		4170077

### 242

TT		8312	<>	<>	325		5444453
----	--	------	----	----	-----	--	---------

**TUBI FLESSIBILI PER FRENO**

**L**

**o.e.**
**900 T - E**

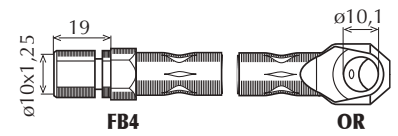
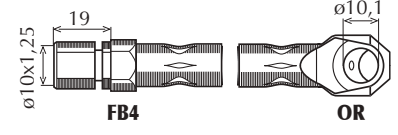
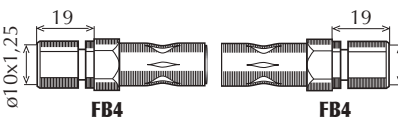
900 T (Circuito semplice)		<b>8142</b>	<>		432		4171159
900 T - E (Circuito Doppio)		<b>8141</b>	<>		410		4473011
900 T - E (TT)		<b>8143</b>	<>		240		4167824

**DUCATO**

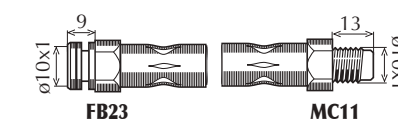
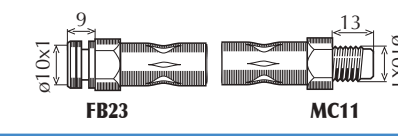
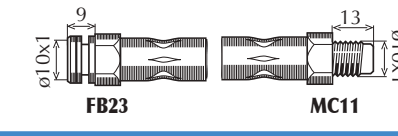
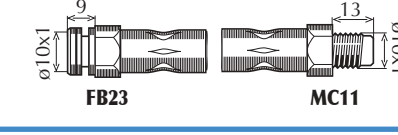
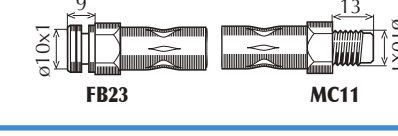
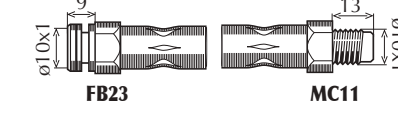
TT (- 4x4) (Superiore)	10/81-01/83	<b>8364</b>	<>		388		5952297
TT (- 4x4) (Inferiore)	10/81-01/83	<b>8365</b>	<>		388		5952296
TT (- 4x4) (Superiore)	02/83-02/94	<b>8410</b>	<>		460		7567861
TT (- 4x4) (Inferiore)	02/83-02/94	<b>8411</b>	<>		460		7567862
4X4	10/81-02/94	<b>8408</b>	<>		310		5950690
TT (- 4x4)	10/81-02/94	<b>8354</b>	<>		284		7570315

**DUCATO (Mod. 94)**

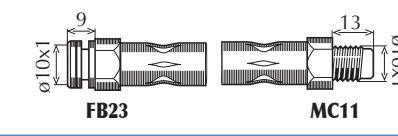
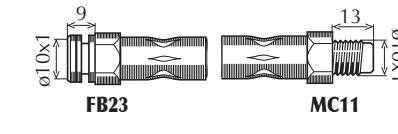
TT	02/94-	<b>8571</b>	<>		490		1311401080
TT (-ABS)	02/94-	<b>8531</b>	<>		350		7662724



## TUBI FLESSIBILI PER FRENO

**L**

**o.e.**

### segue DUCATO (Mod. 94)

TT (+ABS)	02/94-	<b>8517</b>		▼	360	<p>FB23 MC11</p>	1306893080
TT (+ABS)	02/94-	<b>8425</b>		▲	335	<p>FB23 MC11</p>	7649589

### DUCATO (Mod. 2002)

TT	11/01->	<b>80183</b>	<>		500	<p>FB23 MC11</p>	51748935
TT (centrale)	11/01->	<b>80177</b>		○	382	<p>FB23 MC11</p>	46833121
TT	11/01->	<b>8459</b>		<>	182	<p>FB23 MC11</p>	46786435

### DUCATO (Mod. 2006)

TT	07/06-	<b>80243</b>	<>		515	<p>FB23 MC11</p>	51725095
TT	07/06-	<b>80284</b>		<>	440	<p>FB79 MC55</p>	51725096
TT (Carreggiata maggiorata)	07/06-	<b>80285</b>		<>	515	<p>FB79 MC55</p>	51782767

### Ducato MY2011 (2011->)

TT	2011-	<b>80243</b>	<>		515	<p>FB23 MC11</p>	51725095
TT	2011-	<b>80284</b>		<>	440	<p>FB79 MC55</p>	1367814080

Legenda/Legend: ○ = Intermedio/Intermediate - ● = Interno/Inner - ▲ = Superiore/Upper - ▼ = Inferiore/Lower



**TUBI FLESSIBILI PER FRENO**

**L**

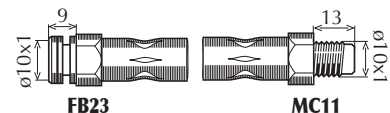
**o.e.**
**segue Ducato MY2011 (2011->)**

TT (carreggiata maggiorata)	2011-	<b>81035</b>	<>		505	 <b>FB23</b> <b>MC11</b>	1367815080
--------------------------------	-------	--------------	----	--	-----	---	------------

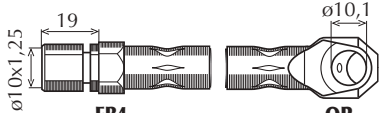

**FIORINO**
**(->08/83)**

TT	77-08/83	<b>8266</b>	<>		300	 <b>FB4</b> <b>OR</b>	4253987
TT	77-08/83	<b>8269</b>	<>		265	 <b>FB4</b> <b>OR</b>	7593342

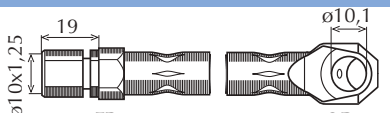
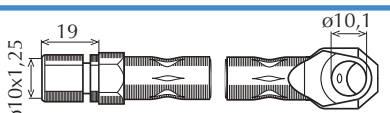
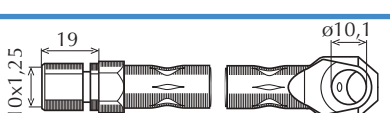
**(09/83->88)**

TT	09/83-88	<b>8362</b>	>		305	 <b>FB4</b> <b>OR</b>	7593341
TT	09/83-88	<b>8144</b>	<		285	 <b>FB4</b> <b>OR</b>	4167826
TT	09/83-88	<b>8269</b>	<>		265	 <b>FB4</b> <b>OR</b>	7593342

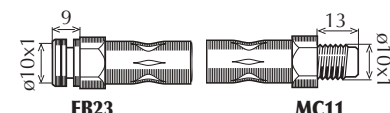
**Nuovo (88->93)**

TT	88-93	<b>8352</b>	<>		436	 <b>FB23</b> <b>MC11</b>	7569161
TT	88-93	<b>8351</b>	<>		218	 <b>FB23</b> <b>FB23</b>	5944002

**Nuovo (Mod.93)**

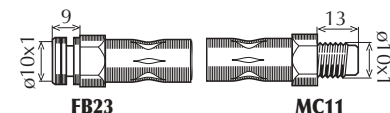
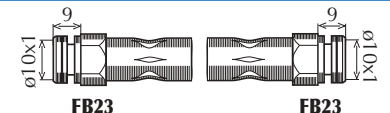
TT	93-01	<b>8920</b>	<>		385	 <b>FB23</b> <b>MC11</b>	50008743
TT	93-01	<b>8921</b>	<>		395	 <b>FB23</b> <b>FB23</b>	7762435

## TUBI FLESSIBILI PER FRENO

**L**

**o.e.**

### segue FIORINO

**(Mod 2008)**

TT	01/08-	<b>80188</b>	<>		425	 <b>FB23</b> <b>MC11</b>	55701047
TT	01/08-	<b>80303</b>	<>		195	 <b>FB79</b> <b>FB79</b>	51790084

### SCUDO

TT	06/94-	<b>8569</b>	<>		515	 <b>FZ</b> <b>MG1</b>	1479197080
TT (Intermedio)	06/94-	<b>8573</b>	<>		275	 <b>FZ</b> <b>FZ</b>	1472157080
TT	06/94-	<b>8570</b>	<>		325	 <b>FZ</b> <b>MC11</b>	1472155080

### SCUDO (Mod. 2007)

TT	01/07-	<b>80361</b>	<>		510	 <b>FZ2</b> <b>MG9</b>	1498442080
TT (Passo Corto)	01/07-	<b>80318</b>	<>		270	 <b>FZ2</b> <b>FZ2</b>	1401070380
TT (Passo Lungo)	01/07-	<b>80329</b>	<>		380	 <b>FZ2</b> <b>FZ2</b>	1401070480

### TALENTO

TT (Superiore)	09/88-	<b>8410</b>	<>		460	 <b>FB23</b> <b>MC11</b>	7567861
TT (Inferiore)	09/88-	<b>8411</b>	<>		460	 <b>FB23</b> <b>MC11</b>	7567862

Legenda/Legend: ○ = Intermedio/Intermediate - ● = Interno/Inner - ▲ = Superiore/Upper - ▼ = Inferiore/Lower

**TUBI FLESSIBILI PER FRENO**

**L**

**o.e.**
**segue TALENTO**

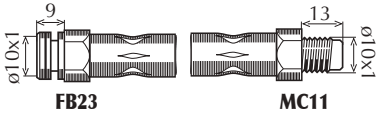
TT	09/88-	8425	<>	335		7569593
----	--------	------	----	-----	--	---------

**FIAT VEICOLI INDUSTRIALI**
**130NC**

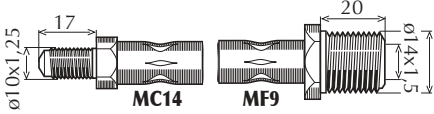
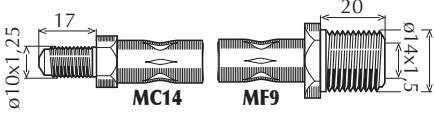
TT		8288	<>	590		4294438
TT		8288	<>	590		4294438

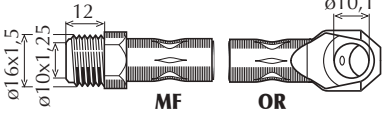
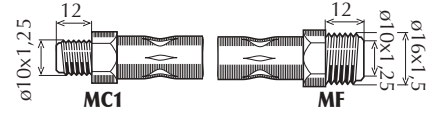

**615N,N1 - 616N,N1,N2,N2/4,N3,N3/N4 - 625N,N1,N2,N3**
**615N,N1 - 616N,N1**

TT		8028	<>	381		997250
TT		8003	<>	312		4023585

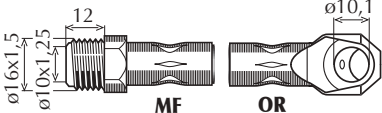
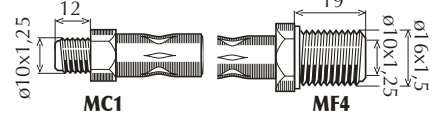
**616N,N1,N2,N2/4,N3,N3/N4**

TT		8270	<>	405		4188308
TT		8076	<>	327		4087084

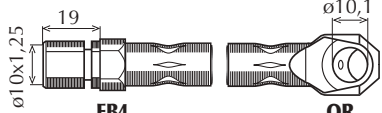
**625 N,N1,N2,N2P**

TT		8075	<>	495		4158738
TT		8076	<>	327		4087084

## TUBI FLESSIBILI PER FRENO



o.e.

segue 615N,N1 - 616N,N1,N2,N2/4,N3,N3/N4 - 625N,N1,N2,N3

625 N3

TT		8157	<>		437	<p>MC14 MF8</p>	8544448
TT		8156	<>		495	<p>MC14 MF8</p>	8536129

645N, N1, N2, N3 - 650N, N1, N2, N3 - 650E, E1 - 655N, N1 - 662N, N1, N2, N3 - 672N - 673 N

TT		8001	<>		470	<p>MC MC</p>	4097914
TT		8001	<>		470	<p>MC MC</p>	4097914



**TUBI FLESSIBILI PER FRENO**

**L**

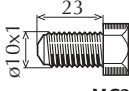
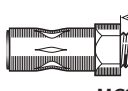

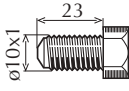
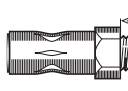
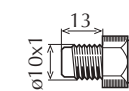
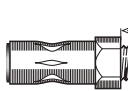
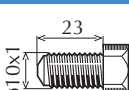

**o.e.**
**CAPRI**

TT	74-84	<b>8200</b>	<>		280	 <b>MC22</b>	 <b>MC22</b>	1572004
----	-------	-------------	----	--	-----	---	--	---------

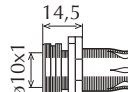
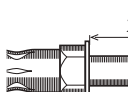

**CORTINA**

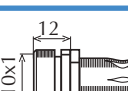
TT	73-75	<b>8203</b>	<>		470	 <b>MC22</b>	 <b>MC22</b>	1572002
TT	76-09/82	<b>8461</b>	<>		375	 <b>MC11</b>	 <b>MC22</b>	6135220
TT	73-09/82	<b>8200</b>	<>		280	 <b>MC22</b>	 <b>MC22</b>	1572004

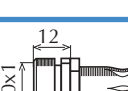
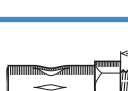
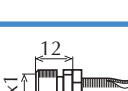
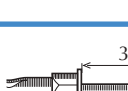
**C-MAX I**

TT	10/03-03/07	<b>80388</b>	<>		435	 <b>FB78</b>	 <b>MCL2</b>	1387264
TT (Tamburo)	11/04-03/07	<b>80306</b>	<>		410	 <b>FB42</b>	 <b>MC55</b>	1405494
TT (disco)	10/03-03/07	<b>80321</b>	<>		440	 <b>FB42</b>	 <b>MC55</b>	1387272
TT (disco) (con freno a mano elettrico)	10/03-12/03	<b>80321</b>	<>		440	 <b>FB42</b>	 <b>MC55</b>	1387272
TT (disco) (con freno a mano elettrico)	01/04-03/07	<b>80246</b>	<>		438	 <b>FB42</b>	 <b>MCL</b>	1361292

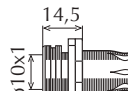
**C-MAX II**

TT	02/07-	<b>80388</b>	<>		435	 <b>FB78</b>	 <b>MCL2</b>	1387264
----	--------	--------------	----	--	-----	---	--	---------

## TUBI FLESSIBILI PER FRENO



L



o.e.

### segue C-MAX II

TT (Tamburo)	02/07-	<b>80321</b>	<>	440	<p>FB42 MC55</p>	1387272
TT (Disco)	02/07-	<b>80750</b>	<>	435	<p>FB42 MC55</p>	1424802

### C-MAX III (Mod 2010) - GRAND C-MAX

TT	12/10-	<b>81036</b>	<>	460	<p>FB61 MG16</p>	1682557
TT	12/10-	<b>81037</b>	<>	450	<p>FB42 MC55</p>	1681131

### ESCORT (-08/80)

TT	-08/80	<b>8200</b>	<>	280	<p>MC22 MC22</p>	1572004
TT	-08/80	<b>8200</b>	<>	280	<p>MC22 MC22</p>	1572004

### ESCORT (80-86)

TT	08/80-12/85	<b>8209</b>	<>	270	<p>MC11 MC22</p>	6085217
TT	08/80-12/85	<b>8463</b>	>	225	<p>MC39 MC40</p>	4167824
TT	08/80-12/85	<b>8462</b>	<	250	<p>MC39 MC40</p>	4167824
TT Van	08/80-12/85	<b>8688</b>	<>	385	<p>FB40 FB40</p>	1613350

Legenda/Legend: ○ = Intermedio/Intermediate - ● = Interno/Inner - ▲ = Superiore/Upper - ▼ = Inferiore/Lower

**TUBI FLESSIBILI PER FRENO**

**o.e.**
**ESCORT (86-90)**

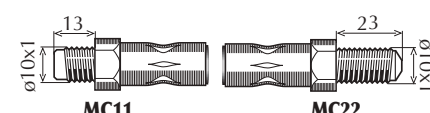
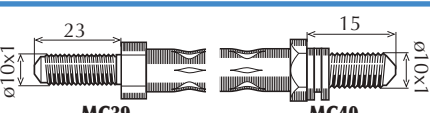
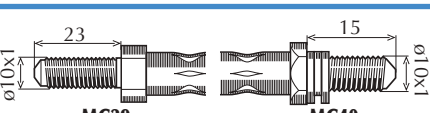
TT	01/86-08/90	<b>8461</b>	<>		375	 <p>MC11 MC22</p>	6135220
TT	01/86-08/90	<b>8463</b>		>	225	 <p>MC39 MC40</p>	4167824
TT	01/86-08/90	<b>8462</b>		<	250	 <p>MC39 MC40</p>	4167824

**ESCORT (90-95) Berlina**

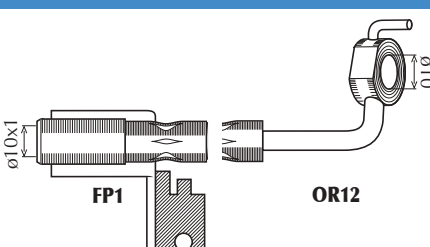
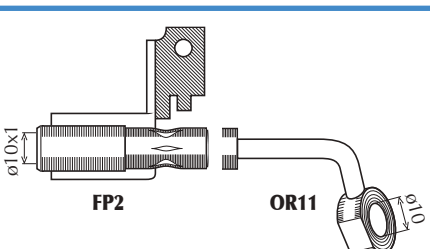
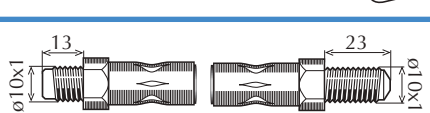
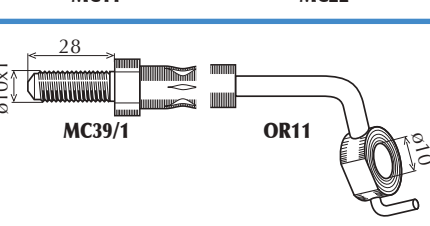
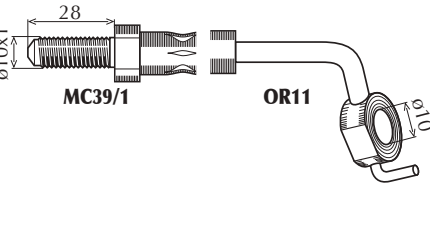
TT (- 1.6 16V)	09/90-92	<b>8578</b>		>	450	 <p>FP1 OR12</p>	7111983
TT (- 1.6 16V)	09/90-92	<b>8579</b>		<	450	 <p>FP2 OR11</p>	7111981
TT (- 1.6 16V)	09/90-92	<b>8581</b>		<>	495	 <p>MC11 MC22</p>	7272225
TT (- 1.3 +ABS, 1.6 16V)	92-12/94	<b>8558</b>		>	470	 <p>MC39/1 OR11</p>	6941702
TT (- 1.3 +ABS, 1.6 16V)	92-12/94	<b>8556</b>		<	470	 <p>MC39/1 OR11</p>	6941703



## TUBI FLESSIBILI PER FRENO



L



o.e.

### segue ESCORT (90-95) Berlina

TT (- 1.3 +ABS, 1.6 16V)	92-12/94	8580	<>	490	<p>MC11 MC22</p>	1666294
1.3 (+ ABS)	92-12/94	8556	▼	470	<p>MC39/1 OR11</p>	6941703
1.3 (+ ABS)	92-12/94	8555	▲	470	<p>MC39/1 OR12</p>	6941705
1.3 (+ ABS)	92-12/94	8580	<>	490	<p>MC11 MC22</p>	1666294
1.6 16V	09/90-11/94	8557	▼	470	<p>MC39/1 OR12</p>	6941704
1.6 16V	09/90-11/94	8558	▲	470	<p>MC39/1 OR11</p>	6941702
1.6 16V	09/90-11/94	8581	<>	495	<p>MC11 MC22</p>	7272225
1.6 16V	11/94-12/94	8578	▼	450	<p>FP1 OR12</p>	7111983

Legenda/Legend: ○ = Intermedio/Intermediate - ● = Interno/Inner - ▲ = Superiore/Upper - ▼ = Inferiore/Lower

## TUBI FLESSIBILI PER FRENO





L

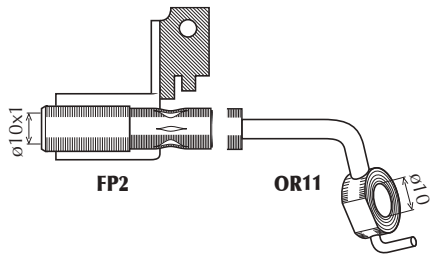

o.e.

### segue ESCORT (90-95) Berlina

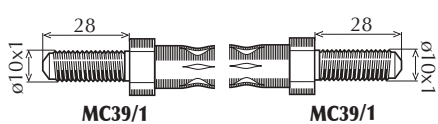
1.6 16V	11/94-12/94	8579	◁		450	 <p>FP2 OR11</p>	7111981
1.6 16V	11/94-12/94	8581		◁ ▷	495	 <p>MC11 MC22</p>	7272225
TT 4X4	92-12/94	8586		◁ ▷	360	 <p>MC39/1 MC39/1</p>	6983011

### ESCORT (90-95) SW

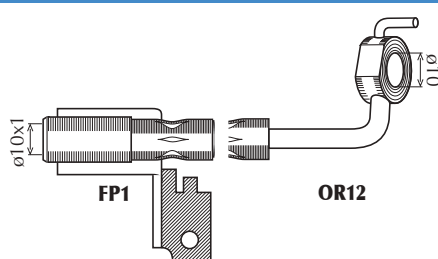
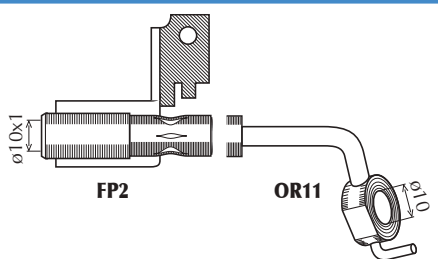
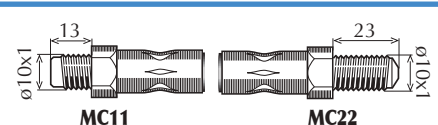
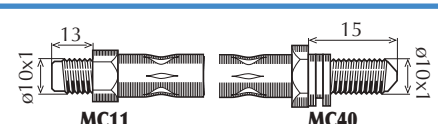
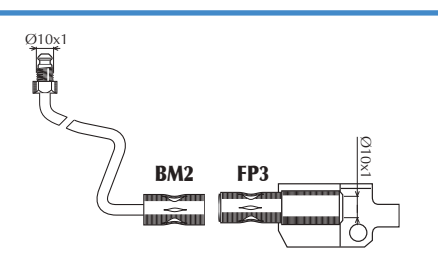
TT	09/90-12/94	8578	▷		450	 <p>FP1 OR12</p>	7111983
TT	09/90-12/94	8579	◁		450	 <p>FP2 OR11</p>	7111981
TT	09/90-11/90	8587		◁ ▷	450	 <p>MC11 MC22</p>	6508658
TT	12/90-09/91	8600		◁ ▷	355	 <p>MC11 MC40</p>	6125634
TT	09/91-12/94	8602	▷		426	 <p>BM2 FP3</p>	6823334

## TUBI FLESSIBILI PER FRENO



L



o.e.

### segue ESCORT (90-95) SW

TT	09/91-12/94	8601	▼	426		6823335
----	-------------	------	---	-----	--	---------

### ESCORT (95-)



TT	01/95-09/98	8583	▼	405		1041774
TT	01/95-09/98	8582	◀	405		1041775
TT SW - Van	09/98-08/00	80231	▼	315		1051514
TT SW - Van	09/98-08/00	80233	◀	315		1051516
TT Berlina	01/95-09/98	8585	◀▶	335		7402895
TT SW	01/95-08/00	8922	◀▶	365		1011293

Legenda/Legend: ○ = Intermedio/Intermediate - ● = Interno/Inner - ▲ = Superiore/Upper - ▼ = Inferiore/Lower

**TUBI FLESSIBILI PER FRENO**

**L**

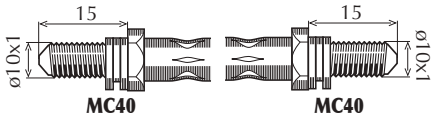

**o.e.**
**segue ESCORT (95-)**

TT Van	01/95-08/00	<b>8689</b>	<>	435	 <b>MC40</b>	6714709
XR3i RS 2000	01/95-09/98	<b>8584</b>	<>	440	 <b>MC11</b> <b>MC42</b>	1013455
XR3i RS 2000 4X4	01/95-09/98	<b>8586</b>	<>	360	 <b>MC39/1</b> <b>MC39/1</b>	6983011

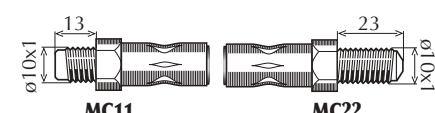
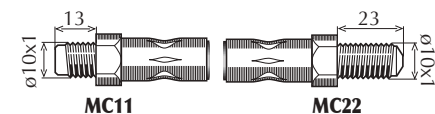
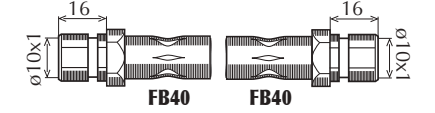
**FIESTA I - II(77-89)**

TT	05/76-08/83	<b>8209</b>	<>	270	 <b>MC11</b> <b>MC22</b>	6085217
TT	09/83-03/89	<b>8460</b>	<>	385	 <b>MC11</b> <b>MC22</b>	6114613
TT	05/76-03/89	<b>8222</b>	<>	315	 <b>FB40</b> <b>FB40</b>	6049556

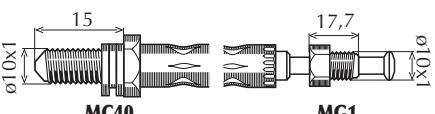
**FIESTA III (89-95)**

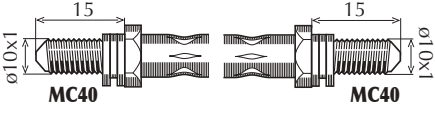
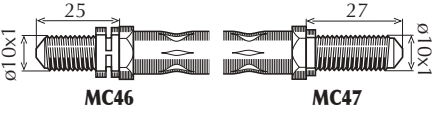
TT	02/89-12/95	<b>8604</b>	>	415	 <b>MC40</b> <b>MG1</b>	1021841
TT	02/89-12/95	<b>8605</b>	<	435	 <b>MC11</b> <b>MC22</b>	1013815
TT	02/89-12/95	<b>8565</b>	<>	340	 <b>MC40</b> <b>MC40</b>	6714710
1.3 Van (Courier)	02/89-12/95	<b>8690</b>	<>	335	 <b>MC46</b> <b>MC47</b>	1018615

## TUBI FLESSIBILI PER FRENO

**L**

**o.e.**

### FIESTA IV (95-02)

TT	08/95->02	<b>8604</b>	▼		415	<p><b>MC40</b>      <b>MG1</b></p>	1021841
TT	08/95->02	<b>8687</b>	▲		415	<p><b>MC40</b>      <b>MG1</b></p>	1066796
TT	08/95->02	<b>8607</b>	<>		335	<p><b>MC11</b>      <b>MC42</b></p>	1014204

### FIESTA V (11/01-)

TT	11/01-	<b>8914</b>	<>		520	<p><b>FB69</b>      <b>MG1</b></p>	1201141
TT	11/01-	<b>8970</b>	<>		325	<p><b>FB61</b>      <b>FB61</b></p>	1217819

### FIESTA VI (10/08-)

TT	11/01-	<b>80751</b>	<>		405	<p><b>FB61</b>      <b>OR71</b></p>	1522925
TT (Interno)	11/01-	<b>80752</b>	<>		285	<p><b>FB61</b>      <b>FB61</b></p>	1554797

### FOCUS

TT	10/98-	<b>8608</b>	<>		370	<p><b>FB42</b>      <b>MC54</b></p>	1068964
TT	10/98-09/00	<b>8609</b>	<>		225	<p><b>FB42</b>      <b>FB42</b></p>	1064257
TT	09/00-	<b>80267</b>	<>		445	<p><b>FB42</b>      <b>MC54</b></p>	1124059

Legenda/Legend: ○ = Intermedio/Intermediate - ● = Interno/Inner - ▲ = Superiore/Upper - ▼ = Inferiore/Lower



**TUBI FLESSIBILI PER FRENO**

**L**

**o.e.**
**segue FOCUS**

TT (alla pinza)	10/98-	<b>8923</b>	<>	195		1068975
-----------------	--------	-------------	----	-----	--	---------

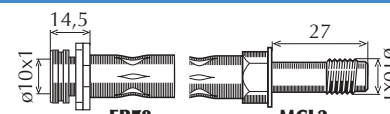
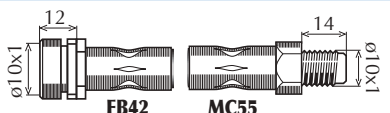
**FOCUS II**

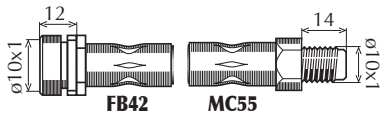
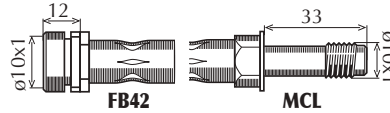
TT	06/03-	<b>80388</b>	<>	435		1387264
TT (Tamburo Post.)	11/04-	<b>80306</b>	<>	410		1405494
TT (Disco Post.) (no freno a mano elettrico)	06/03-	<b>80321</b>	<>	440		1387272
TT (Disco Post.) (con freno a mano elettrico)	06/03-12/03	<b>80321</b>	<>	440		1387272
TT (Disco Post.) (con freno a mano elettrico)	01/04-	<b>80246</b>	<>	438		1361292

**FOCUS II (Restyling 2008->)**

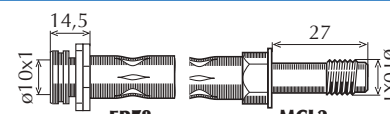
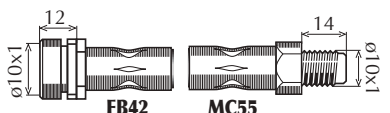
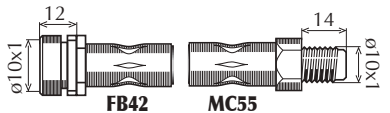
TT	02/07-	<b>80388</b>	<>	435		1387264
TT (Tamburo)	02/07-	<b>80306</b>	<>	410		1405494
TT (Disco)	02/07-	<b>80750</b>	<>	435		1424802

**Focus III (Mod 2011)**

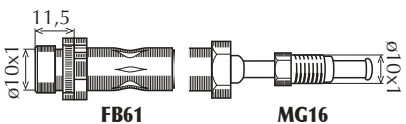
TT	04/11-	<b>81036</b>	<>	460		1682557
----	--------	--------------	----	-----	--	---------

## TUBI FLESSIBILI PER FRENO



L



o.e.

### segue Focus III (Mod 2011)

TT (Berlina)	04/11-	81037	<>	450		1681131
TT (SW)	04/11-	81038	<>	450		1702987

### FUSION

TT	08/02-	80000	<>	545		1211729
TT	08/02-	80001	<>	345		1207358

### GALAXY

TT	11/95-03/00	8924	<>	500		7335771
TT	04/00-	80258	<>	480		1304007
TT	11/95-	80244	<>	400		7335770
TT (alla pinza)	11/95-	8925	<>	185		1044504

### GALAXY (MOD. 2006)

TT	05/06-	80450	<>	420		1379911
TT	05/06-08/06	80356	<>	215		1435173

Legenda/Legend: ○ = Intermedio/Intermediate - ● = Interno/Inner - ▲ = Superiore/Upper - ▼ = Inferiore/Lower

## TUBI FLESSIBILI PER FRENO



L



o.e.

### segue GALAXY (MOD. 2006)

TT	09/06-	80760	<>	200		1671646
----	--------	-------	----	-----	--	---------

### GRANADA

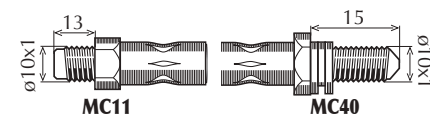
TT	02/85-91	8600	<>	355		6125634
----	----------	------	----	-----	--	---------

TT	02/85-91	8565	<>	340		6179304
----	----------	------	----	-----	--	---------

### KA

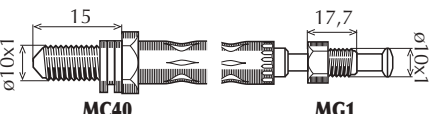
TT	09/96-01/01	8610	<>	535		1035269
----	-------------	------	----	-----	---	---------

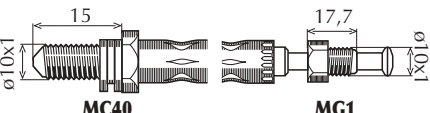
TT	02/01-	80190	<>	525		1151292
----	--------	-------	----	-----	--	---------

TT	09/96-01/02	8612	<>	390		1042122
----	-------------	------	----	-----	--	---------

TT	02/02-	80191	<>	365		1323555
----	--------	-------	----	-----	--	---------

### KA (Mod.2009)

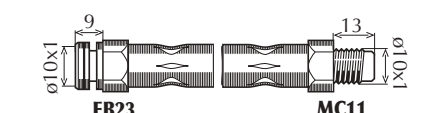
TT	02/09->	80755	<>	385		1563598
----	---------	-------	----	-----	--	---------

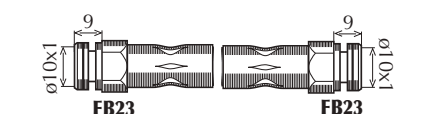
TT	02/09->	80758	<>	190		1566996
----	---------	-------	----	-----	--	---------

### KUGA

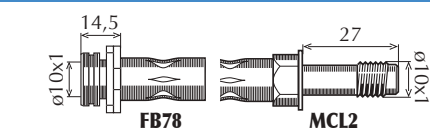
TT	03/08-	80388	<>	435		1387264
----	--------	-------	----	-----	--	---------



## TUBI FLESSIBILI PER FRENO



L



o.e.

### segue KUGA

TT	03/08-	80761	<>	500		1501841
----	--------	-------	----	-----	--	---------

### MONDEO I-II (93-11/00)

TT	02/93-11/00	8645	<>	425		7067563
TT	02/93-08/96	8646	<>	305		6758585
TT Berlina (Tamburo Post.)	09/96-11/00	8647	<>	315		1023692
TT SW (Tamburo Post.)	09/96-11/00	8686	<>	345		6758587
TT Berlina (Disco Post.)	09/96-08/96	8648	<>	580		1025018
TT Berlina (Disco Post.)	09/96-11/00	80307	<>	575		1071939
TT SW (Disco Post.)	09/96-05/97	8649	<>	325		6922621
TT SW (Disco Post.)	06/97-11/00	80234	<>	340		1071941

### MONDEO III (11/00-)

TT	11/00-	8998	<>	475		1212748
TT	11/00-	8999	<>	313		1121635

Legenda/Legend: ○ = Intermedio/Intermediate - ● = Interno/Inner - ▲ = Superiore/Upper - ▼ = Inferiore/Lower

## TUBI FLESSIBILI PER FRENO





L

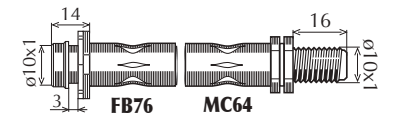

o.e.

### MONDEO IV (03/07-)

TT	03/07-	80450	<>		420		1379911
TT	03/07-	80760	<>		200		1671646

### ORION

#### (83-08/90)

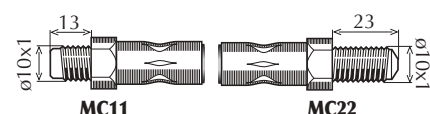
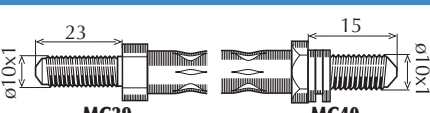
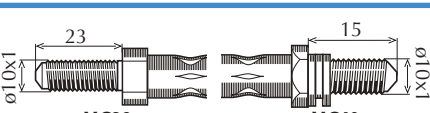
TT	05/83-08/90	8461	<>		375		6135220
TT	05/83-08/90	8463	>		225		4167824
TT	05/83-08/90	8462	<		250		4167824

#### (08/90-93)

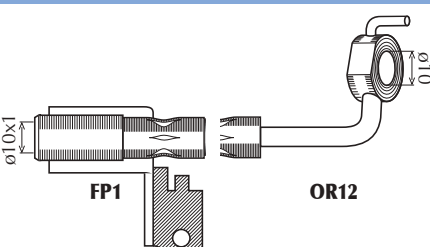
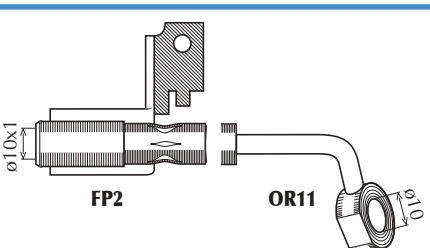
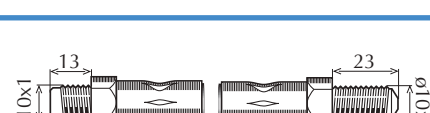
TT	09/90-03/93	8578	>		450		7111983
TT	09/90-03/93	8579	<		450		7111981
TT	09/90-03/93	8580	<>		490		1666294

## TUBI FLESSIBILI PER FRENO



L



o.e.

### PUMA

TT	03/97-	<b>8604</b>	▼		415	<p>MC40 MG1</p>	1021841
TT	03/97-	<b>8605</b>	▲		435	<p>MC11 MC22</p>	1013815
TT (- ABS)	03/97-	<b>8612</b>		<>	390	<p>MC11 MC42</p>	1042122
TT (+ ABS)	03/97-	<b>8607</b>		<>	335	<p>MC11 MC42</p>	1014204



### SIERRA

TT	07/82-07/85	<b>8205</b>		<>	375	<p>MC11 MC22</p>	1613346
TT	08/85-02/93	<b>8600</b>		<>	355	<p>MC11 MC40</p>	6125634
TT	07/82-02/93	<b>8565</b>		<>	340	<p>MC40 MC40</p>	6714710

### S-MAX

TT	05/06-	<b>80450</b>		<>	420	<p>FB76 MC64</p>	1379911
TT	05/06-08/06	<b>80356</b>		<>	215	<p>FB76 MCL2</p>	1435173
TT	09/06-	<b>80760</b>		<>	200	<p>FB76 MCL2</p>	1671646

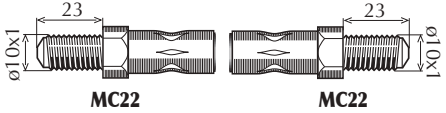
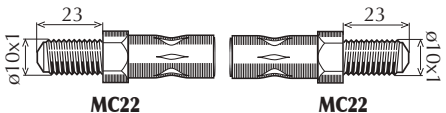
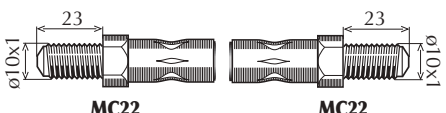
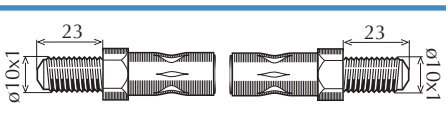
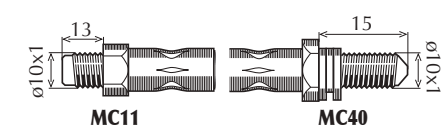
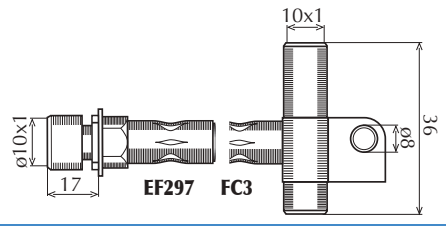
**TUBI FLESSIBILI PER FRENO**

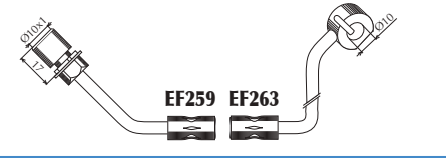
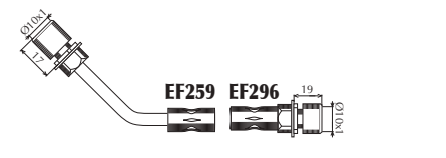
<b>TAUNUS</b>							
TT	07/70-05/73	<b>8202</b>	<>		370	 <p>MC22 MC22</p>	6013897
TT	06/73-12/75	<b>8203</b>	<>		485	 <p>MC22 MC22</p>	1572002
TT	01/76-07/82	<b>8204</b>	<>		485	 <p>MC22 MC22</p>	1572003
TT	07/70-07/82	<b>8200</b>	<>	<>	280	 <p>MC22 MC22</p>	1572004
<b>FORD COMMERCIALI</b>							
<b>P100</b>							
TT	01/88-94	<b>8600</b>	<>		355	 <p>MC11 MC40</p>	6125634
TT	01/88-94	<b>8691</b>	<>	<>	420	 <p>EF297 FC3</p>	6149181
<b>TRANSIT (07/76-&gt;02/86)</b>							
TT (Pinza freno a 2 pistoni)	07/76-02/86	<b>8397</b>	>		278	 <p>EF259 EF262</p>	1631045
TT (Pinza freno a 2 pistoni)	07/76-02/86	<b>8398</b>	<		278	 <p>EF259 EF263</p>	1631046
TT (Pinza freno ant. impianto diagonale)	07/76-02/86	<b>8402</b>	<>		275	 <p>EF259 EF296</p>	1631047

## TUBI FLESSIBILI PER FRENO



o.e.

### segue TRANSIT (07/76->02/86)

TT	07/76-02/86	8698	<>	430		1631051
----	-------------	------	----	-----	--	---------

### TRANSIT (03/86->91)

80 , 100 , 120	03/86-91	8464	>	430		6158424
80 , 100 , 120	03/86-91	8465	<	430		6158425
100 L	03/86-91	8466	>	275		6142527
100 L	03/86-91	8467	<	275		6142528
130 L (Pinza freno a 2 pistoni)	03/86-91	8466	>	275		6142527
130 L (Pinza freno a 2 pistoni)	03/86-91	8467	<	275		6142528
130 L (Pinza freno a 2 pistoni)	03/86-91	8691	<>	420		6149181

Legenda/Legend: ○ = Intermedio/Intermediate - ● = Interno/Inner - ▲ = Superiore/Upper - ▼ = Inferiore/Lower

## TUBI FLESSIBILI PER FRENO



L



o.e.

### segue TRANSIT (03/86->91)

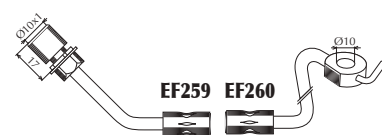
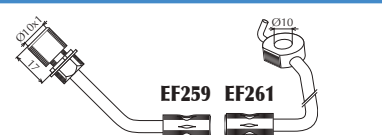
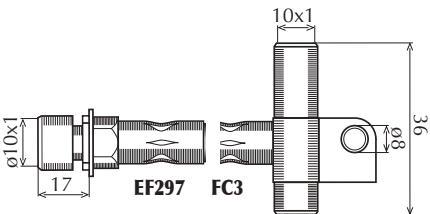
130 , 160, 190 (Pinza freno a 4 pistoni)	03/86-91	<b>8468</b>	>		275		6142529
130 , 160, 190 (Pinza freno a 4 pistoni)	03/86-91	<b>8469</b>	<		275		6142530
130 , 160, 190 (Pinza freno a 4 pistoni)	03/86-91	<b>8691</b>	<>		420		6149181

### TRANSIT (91->)

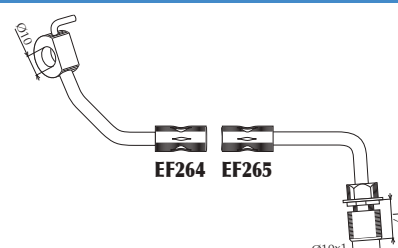
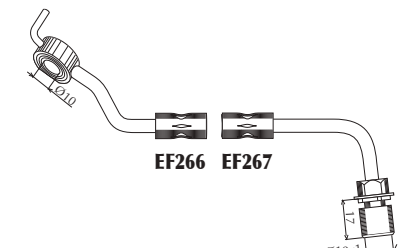
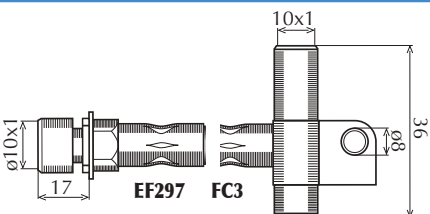
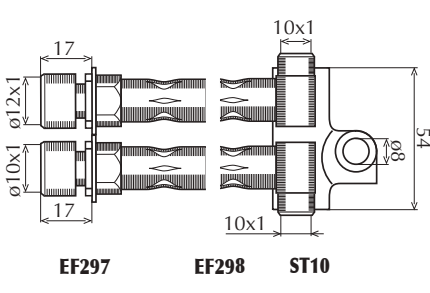
TT	91-03/00	<b>8464</b>	>		430		6158424
TT	91-03/00	<b>8465</b>	<		430		6158425
TT (Tubazioni separate verticalmente)	91-03/00	<b>8691</b>	<>		420		6577425
TT (Tubazioni separate diagonalmente)	91-03/00	<b>8699</b>	<>		440		6577426

## TUBI FLESSIBILI PER FRENO



L



o.e.

### TRANSIT (2000->)

TT	01/00-	80452	▲				4447739
TT	01/00-	80637	▼				4419593
TT (Furgone, Bus)	01/00-	80453		◀ ▶			4409343
TT (Pianale Piatto)	01/00-	80454		◀ ▶			4409342

### TRANSIT (2006->)

TT	07/06-	80965	◀ ▶		370		1694317
TT	07/06-	80966	◀ ▶		285		1438806
TT (Ruote gemellate)	07/06-	80967	◀ ▶		250		1438901

### TRANSIT - TOURNEO CONNECT

TT	06/02-	80354	◀ ▶		370		4447381
TT (- ABS)	06/02-	80261	◀ ▶		385		4447742

Legenda/Legend: ○ = Intermedio/Intermediate - ● = Interno/Inner - ▲ = Superiore/Upper - ▼ = Inferiore/Lower

**TUBI FLESSIBILI PER FRENO**

**L**

**o.e.**
**segue TRANSIT - TOURNEO CONNECT**

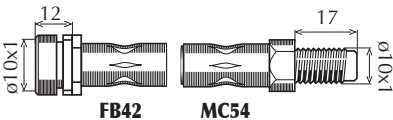
TT (+ ABS)	06/02-	<b>80263</b>	< >	345		4510813
------------	--------	--------------	-----	-----	--	---------



## TUBI FLESSIBILI PER FRENO

**L**

**o.e.**

### ACCORD III

TT	11/85-12.89	<b>80018</b>	▼		677		46410SE0013
TT	11/85-12.89	<b>80019</b>	▲		677		46411SE0013
1.6 L, 2.0 EX (CH:0C054978-) - TT/SW	11/85-12.89	<b>80020</b>		◀▶	345		46430SE0013
2.0 EXi, 2.0 16V (Engine PGM-Fi)	11/85-12.89	<b>80021</b>		◀▶	235		46431SE0934

### ACCORD IV

TT	01/90-08/93	<b>80455</b>	▼		705		46410SN7003
TT	01/90-08/93	<b>80456</b>	▲		710		46411SN7003
TT (- coupè)	01/90-08/93	<b>80020</b>		◀▶	345		46430SE0013
TT (- coupè) (alla pinza)	01/90-08/93	<b>80021</b>		◀▶	235		46431SE0934

### ACCORD V

TT	09/93-01/96	<b>80337</b>	▼		700		01464SM4010
TT	09/93-01/96	<b>80332</b>	▲		700		01465SM4010
TT	09/93-01/96	<b>80313</b>		◀▶	380		01466SL4010

Legenda/Legend: ○ = Intermedio/Intermediate - ● = Interno/Inner - ▲ = Superiore/Upper - ▼ = Inferiore/Lower

## TUBI FLESSIBILI PER FRENO



L



o.e.

### ACCORD VI

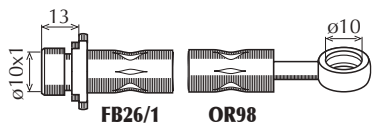
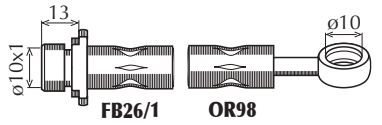
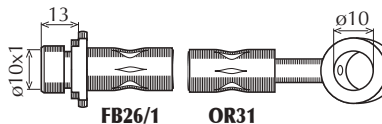
TT	02/96-01/98	80455	▼		705		46410SN7003
TT	02/96-01/98	80456	▲		710		46411SN7003
TT	02/96-01/98	80291		◁ ▷	225		46431SM4951

### ACCORD VII

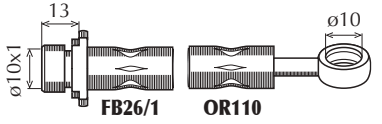
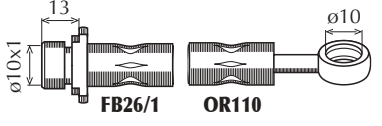
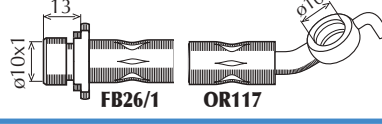
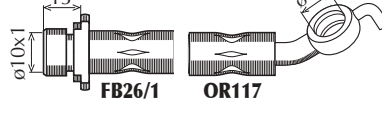
TT	02/98-12/02	80457	▼		460		46410S1AE01
TT	02/98-12/02	80458	▲		460		46411S1AE01
TT	02/98-12/02	80459	▼		425		46430S1AE01
TT	02/98-12/02	80460	▲		425		46431S1AE01

### ACCORD VIII

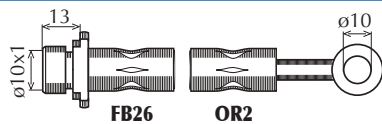
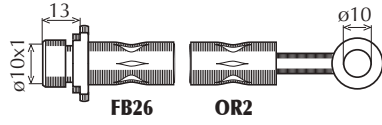
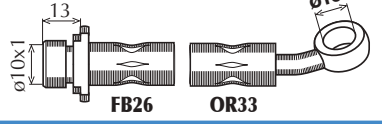
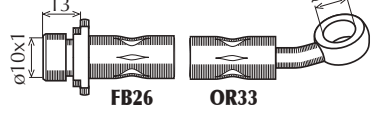
TT	02/03-	80461	▼		470		01464SEAE00
TT	02/03-	80462	▲		470		01465SEAE00
TT (Berlina)	02/03-	80627	▼		475		01466SEAE00
TT (Berlina)	02/03-	80628	▲		475		01468SEAE00

## TUBI FLESSIBILI PER FRENO



L



o.e.

### ACCORD IX

TT	07/08-	80762	▲		510		01465TL1G00
TT	07/08-	80763	▼		505		01464TL1G00
TT	07/08-	80764	▲		490		01468TA0A00
TT	07/08-	80765	▼		490		01466TA0A00

### CIVIC III

TT	10/87-09/91	80022	▼		675		46410SH3033
TT	10/87-12/88	80023	▲		675		46411SH3033
TT	12/88-09/91	80024	▲		670		46411SH3043
TT	10/87-09/91	80025	▲▼		260		01466SD5020

### CIVIC IV

TT	10/91-1994	80022	▼		675		46410SH3033
TT	10/91-1994	80024	▲		670		46411SH3043

## TUBI FLESSIBILI PER FRENO





L



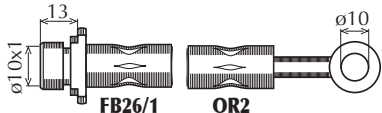

o.e.

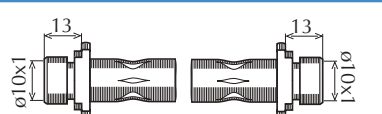
### segue CIVIC IV

TT	09/94-01/97	<b>8093</b>	▼		685		GBH90286
TT	09/94-01/97	<b>8094</b>	▲		685		GBH90337
TT	09/94-01/97	<b>80020</b>	<>		345		46430SE0013

### CIVIC V

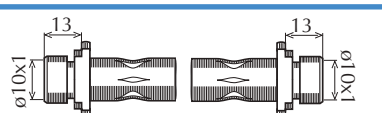
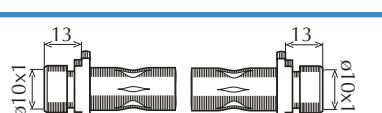
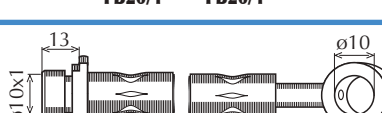
TT	11/95-02/01	<b>8093</b>	▼		685		GBH90286
TT	11/95-02/01	<b>8094</b>	▲		685		GBH90337
TT (4 porte)	11/95-02/01	<b>80020</b>	<>		345		46430SE0013
TT (5 porte+SW) (Tamburo post)	11/97-02/01	<b>80304</b>	<>		245		46430ST3E11
TT (5 porte + SW) (Disco post)	11/97-02/01	<b>80300</b>	<>		580		46430ST3E51

### CIVIC VI

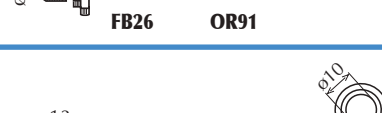
TT	02/01-12/05	<b>80968</b>	▲		575		01465S6D000
TT	02/01-12/05	<b>80969</b>	▼		575		01464S6D000

## TUBI FLESSIBILI PER FRENO



L



o.e.

### segue CIVIC VI

TT	02/01-12/05	80970	▲	490		01468S5AJ04
TT	02/01-12/05	80971	▼	495		01466S5AJ04

### CIVIC VII

TT	01/06-	80972	▲	560		01465SMGE00
TT	01/06-	80973	▼	565		01464SMGE00
TT	01/06-	80974	▲	330/235		01468SMGE00
TT	01/06-	80975	▼	260/235		01466SMGE00

### CONCERTO

TT	08/89-03/95	8478	◀ ▶	505		GBH251
----	-------------	------	-----	-----	--	--------

### CRV I

2.0 16V	10/95-02/02	80463	▼	455		01464S10010
---------	-------------	-------	---	-----	--	-------------

Legenda/Legend: ○ = Intermedio/Intermediate - ● = Interno/Inner - ▲ = Superiore/Upper - ▼ = Inferiore/Lower

## TUBI FLESSIBILI PER FRENO



L



o.e.

### segue CRV I

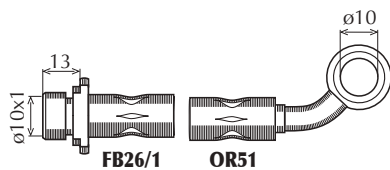
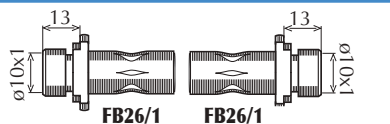
2.0 16V	10/95-02/02	80464	▲		455		01465S10010
2.0 16V	10/95-02/02	80283		◀▶	285		01466S07000

### CRV II

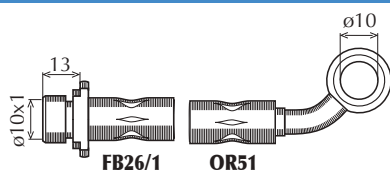
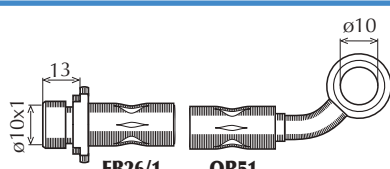
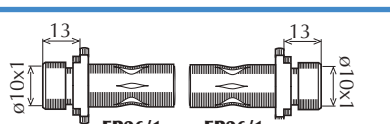
2.0 16V	07/02-09/06	80463	▼		455		01464S10010
2.0 16V	07/02-09/06	80464	▲		455		01465S10010
2.0 16V	07/02-09/06	80283		◀▶	285		01466S07000

### CRV III

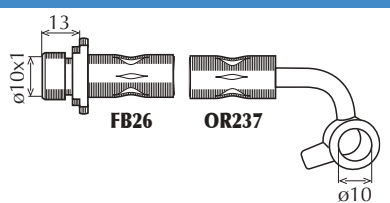
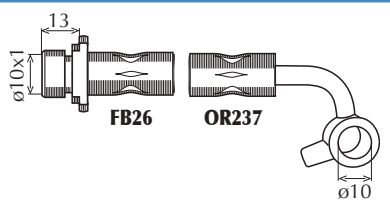
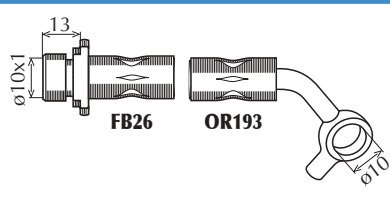
TT	01/07-	80667	▲		445		01465SWA000
TT	01/07-	80668	▼		445		01464SWA000
TT	01/07-	80669		◀▶	490		01466SWA000

## TUBI FLESSIBILI PER FRENO



o.e.

### CRX II

1.6 16V, 1.6 Vtec	10/87-02/92	<b>80022</b>	▼		675		46410SH3033
1.6 16V	10/87-06/88	<b>80023</b>	▲		675		46411SH3033
1.6 16V, 1.6 Vtec	07/88-02/92	<b>80024</b>	▲		670		46411SH3043
TT	10/87-02/92	<b>80020</b>	◀▶		345		46430SE0013

### CRX III

TT	03/92-12/98	<b>80022</b>	▼		675		46410SH3033
TT	03/92-12/98	<b>80024</b>	▲		670		46411SH3043
TT	03/92-12/98	<b>80020</b>	◀▶		345		46430SE0013

### FRV

TT	02/05-	<b>80766</b>	▲		605		01465SJF000
TT	02/05-	<b>80767</b>	▼		605		01464SJF000
TT	02/05-	<b>80768</b>	▲		460		01468SJF010

Legenda/Legend: ○ = Intermedio/Intermediate - ● = Interno/Inner - ▲ = Superiore/Upper - ▼ = Inferiore/Lower

## TUBI FLESSIBILI PER FRENO



L



o.e.

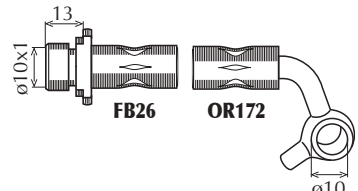

### segue FRV

TT	02/05-	80769	▼	460		01466SJF010
----	--------	-------	---	-----	--	-------------

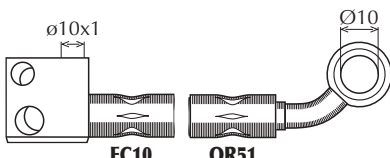
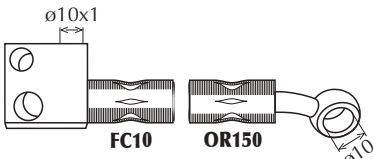
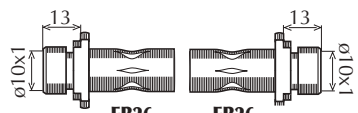
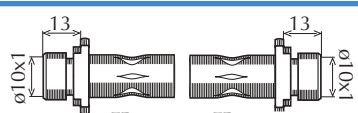
### JAZZ (Mod. 2002)

TT	03/02-07/08	80976	▲	545		01465SAAG01
TT	03/02-07/08	80977	▼	545		01464SAAG01
TT	03/02-07/08	80978	▲	365		01468SAA000
TT	03/02-07/08	80979	▼	300		01466SAA000

### JAZZ (Mod. 2008)

TT	07/08-	80980	▲			01465TF0000
TT	07/08-	80981	▼			01464TF0000

### LOGO

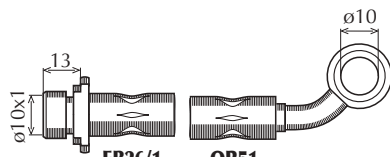
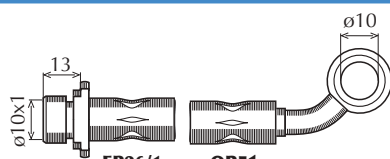
1.3	03/99-03/02	80631	▼	450		01464S2G000
1.3	03/99-03/02	80632	▲	450		01465S2G000



## TUBI FLESSIBILI PER FRENO



L



o.e.

### segue LOGO

1.3	03/99-03/02	80283	< >	285	<p>FB26/1    FB26/1</p>	01466S07000
-----	-------------	-------	-----	-----	-------------------------	-------------

### HRV

TT	03/99-	80465	< >	500	<p>FB26/1    OR51</p>	01464S2H000
TT	03/99-	80295	< >	400	<p>FB26/1    FB26/1</p>	01466S2H000

### PRELUDE IV

TT	02/92-09/96	80466	>	700	<p>FB26/1    OR31</p>	01464SS0020
TT	02/92-09/96	80467	<	700	<p>FB26/1    OR31</p>	01465SS0010
TT	02/92-09/96	80468	>	440	<p>FB26/1    OR33</p>	01466SS0020
TT	02/92-09/96	80469	<	440	<p>FB26/1    OR33</p>	01468SS0010

### PRELUDE V

TT	10/96-10/00	80470	>	430	<p>FB26/1    OR51</p>	01464S30000
TT	10/96-10/00	80471	<	430	<p>FB26/1    OR51</p>	01465S30000

Legenda/Legend: ○ = Intermedio/Intermediate - ● = Interno/Inner - ▲ = Superiore/Upper - ▼ = Inferiore/Lower

## TUBI FLESSIBILI PER FRENO



L



o.e.

### segue PRELUDE V

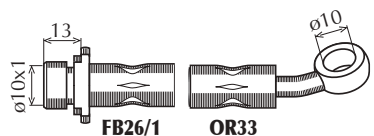
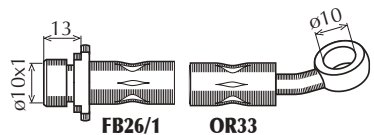
TT	10/96-10/00	<b>80472</b>	▼	440		01466S30000
TT	10/96-10/00	<b>80473</b>	▲	440		01468S30000

### SHUTTLE

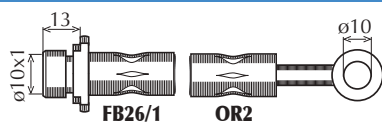
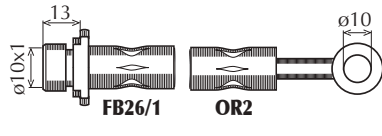
TT	10/94-05/01	<b>80474</b>	▼	705		01465SV4000
TT	10/94-05/01	<b>80475</b>	▲	705		01464SV4000

## TUBI FLESSIBILI PER FRENO



L



o.e.

### ACCENT I

TT	10/94-01/00	80476	▼		515	<p>FB51 OR31</p>	5873122000
TT	10/94-01/00	80477	▲		515	<p>FB51 OR31</p>	5873222000
TT	10/94-01/00	80371	◀▶		265	<p>FB51 FB51</p>	5873722001

### ACCENT II

TT	01/00-	80478	▼		520	<p>FB22 OR31</p>	5873225000
TT	01/00-	80479	▲		520	<p>FB22 OR31</p>	5873125000
TT	01/00-	80325	◀▶		280	<p>FB22 FB22</p>	587371A000

### ACCENT III

TT	11/05-	80770	▲		535	<p>EF307 OR247</p>	587311E000
TT	11/05-	80771	▼		535	<p>EF306 OR251</p>	587321E000
TT	11/05-	80772	▲		505	<p>FB98 OR217</p>	587371G300
TT	11/05-	80773	▼		505	<p>FB98 OR217</p>	587381G300

Legenda/Legend: ○ = Intermedio/Intermediate - ● = Interno/Inner - ▲ = Superiore/Upper - ▼ = Inferiore/Lower

## TUBI FLESSIBILI PER FRENO







L





o.e.

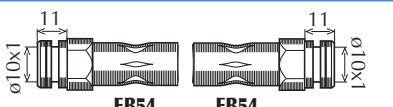

### ATOS - ATOS PRIME

TT	02/98-09/00	<b>80026</b>	▼		385		5873202010
TT	02/98-09/00	<b>80027</b>	▲		385		5873102010
TT	10/00-	<b>80028</b>	◀▶		285		5873102500
TT	02/98-	<b>80029</b>	▼		300		5873802000/1
TT	02/98-	<b>80030</b>	▲		340		5873702000/1

### COUPE I

TT	08/96-04/02	<b>80480</b>	▼		515		5873229010
TT	08/96-04/02	<b>80481</b>	▲		515		5873129020
TT	08/96-04/02	<b>80395</b>	◀▶		485		5873729320

### COUPE II

TT	03/02-	<b>80482</b>	▼		535		587322C100
TT	03/02-	<b>80483</b>	▲		535		587312C100
TT	03/02-	<b>80390</b>	◀▶		485		587372D300

## TUBI FLESSIBILI PER FRENO



L



o.e.

### ELANTRA

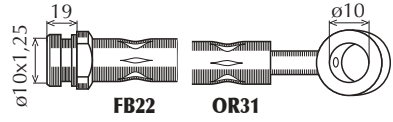
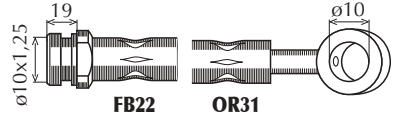
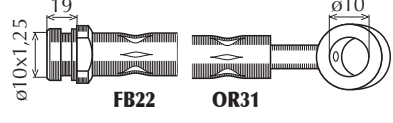
TT	06/00-	<b>80484</b>	▼		505		587322D000
TT	06/00-	<b>80485</b>	▲		505		587312D000
TT	06/00-	<b>80390</b>	◀▶		485		587372D300

### GALLOPER I-II

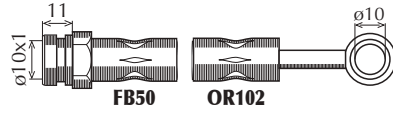
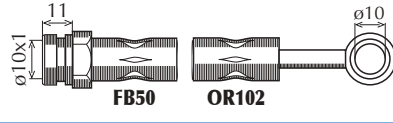
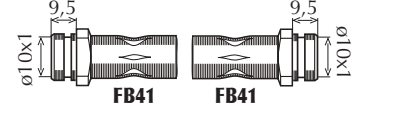
TT	08/91-	<b>80486</b>	▼		455		HB407505
TT	08/91-	<b>80487</b>	▲		455		HB407506
TT	08/91-	<b>80046</b>	◀▶		264		MB238160

### GETZ

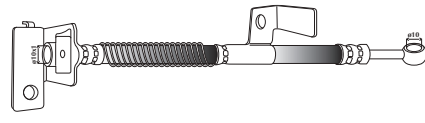
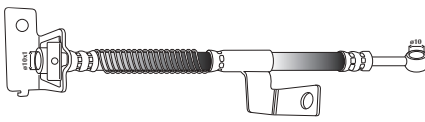
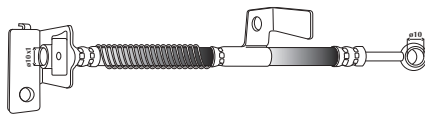
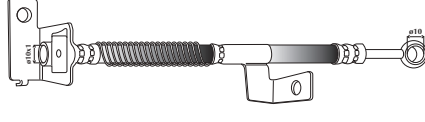
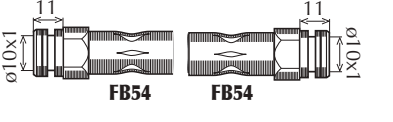
1.1, 1.3, 1.4	09/02-	<b>80488</b>	▼				587321C000
1.1, 1.3, 1.4	09/02-	<b>80489</b>	▲				587311C000
1.6, 1.5 CRDI	09/02-	<b>80490</b>	▼				587311C050
1.6, 1.5 CRDI	09/02-	<b>80491</b>	▲				587311C050
1.1, 1.3, 1.4, 1.6	09/02-	<b>80492</b>	▼		230		587381C000

Legenda/Legend: ○ = Intermedio/Intermediate - ● = Interno/Inner - ▲ = Superiore/Upper - ▼ = Inferiore/Lower

## TUBI FLESSIBILI PER FRENO



L



o.e.

### segue GETZ

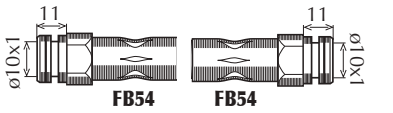
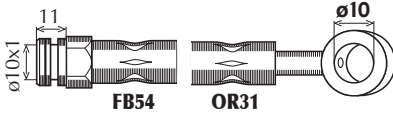
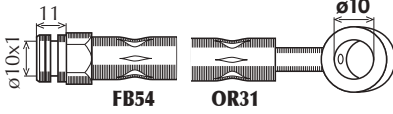
1.1, 1.3, 1.4, 1.6	09/02-	<b>80311</b>	^	280		587371C000
1.5 CRDI	09/02-	<b>80493</b>	v	480		587381C800
1.5 CRDI	09/02-	<b>80494</b>	^	480		587371C800

### I10

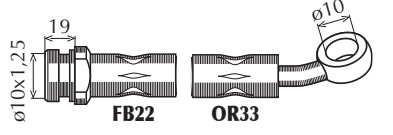
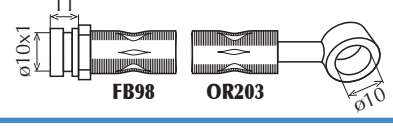
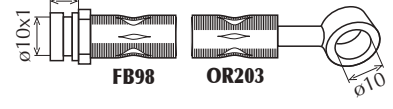
TT	12/07-	<b>80902</b>	^ v	300		587310X000
TT	12/07-	<b>80903</b>	^	410		587370X300
TT	12/07-	<b>80904</b>	v	410		587380X300

### I20

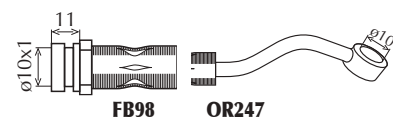
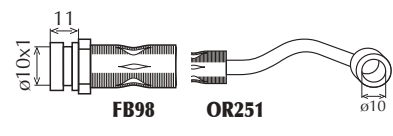
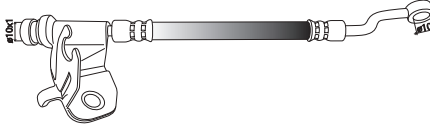
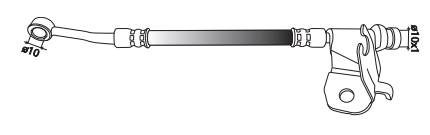
TT	09/08-	<b>80905</b>	^	520		587311J000
TT	09/08-	<b>80906</b>	v	520		587321J000
TT	09/08-	<b>80907</b>	^			587371J300
TT	09/08-	<b>80908</b>	v			587381J300

## TUBI FLESSIBILI PER FRENO



L



o.e.

### I30

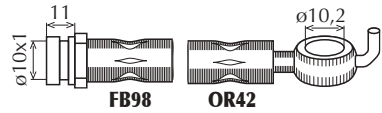
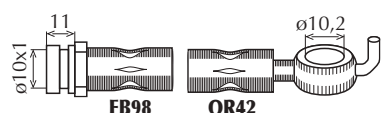
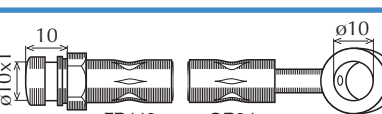
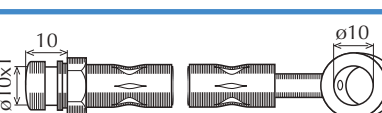
TT	10/07-	<b>80909</b>	▲		540		587312L000
TT	10/07-	<b>80910</b>	▼		540		587322L000
TT	10/07-	<b>80911</b>	▲		310		587372L700
TT	10/07-	<b>80912</b>	▼		310		587372L900

### I40

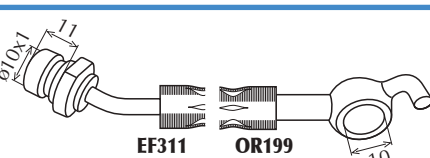
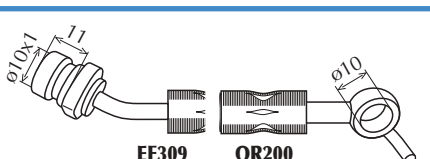
TT	03/12-	<b>81039</b>	▲			Il disegno non è disponibile The drawing is not available	587313Z000
TT	03/12-	<b>81040</b>	▼			Il disegno non è disponibile The drawing is not available	587323Z000
TT	03/12-	<b>81041</b>	▲		345		587373Z000
TT	03/12-	<b>81042</b>	▼		345		587383Z000

### IX20

TT	11/10-	<b>81043</b>	▲		565		587311K000
TT	11/10-	<b>81044</b>	▼			Il disegno non è disponibile The drawing is not available	587321K001

## TUBI FLESSIBILI PER FRENO



L





o.e.

### segue IX20

TT	11/10-	<b>80796</b>	▲			normale	587371P300
TT	11/10-	<b>80797</b>	▼			Il disegno non è disponibile The drawing is not available	587381P300

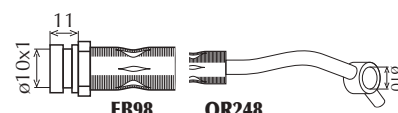
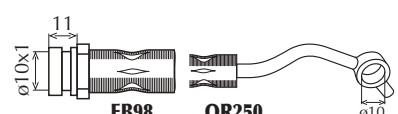
### IX35

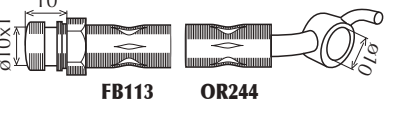
TT	01/10-	<b>80913</b>	▲		555	 FB98 OR248	587312S100
TT	01/10-	<b>80914</b>	▼		555	 FB98 OR250	587322S100
TT	01/10-	<b>80915</b>	▲		345	 FB113 OR245	587372S100
TT	01/10-	<b>80916</b>	▼		345	 FB113 OR244	587382S100

### LANTRA II

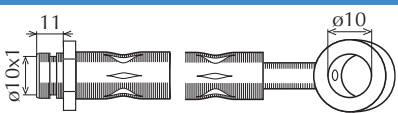
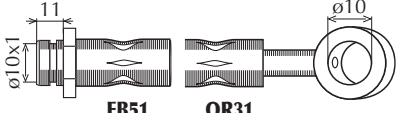
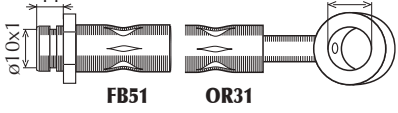
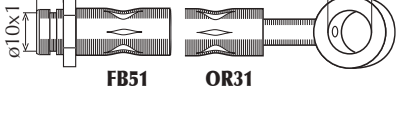
TT	11/95-09/00	<b>80480</b>	▼		515	 FB51 OR31	5873229010
TT	11/95-09/00	<b>80481</b>	▲		515	 FB51 OR31	5873129020
TT	11/95-09/00	<b>80495</b>	▼		485	 FB51 OR31	5874729310
TT	11/95-09/00	<b>80395</b>	▲		485	 FB51 OR31	5873729320



## TUBI FLESSIBILI PER FRENO



L



o.e.

### MATRIX

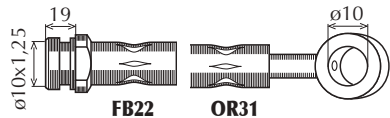
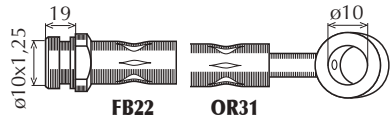
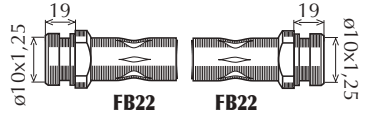
TT	06/01-	<b>80496</b>	▼		520		5873217000
TT	06/01-	<b>80497</b>	▲		520		5873117000
TT	06/01-	<b>80316</b>		◀▶	330		5873717000

### SANTA FE' I

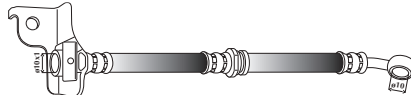
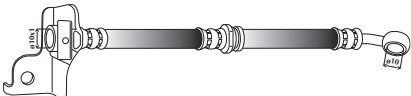
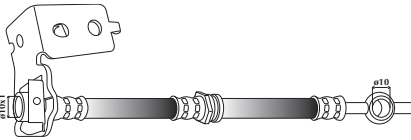
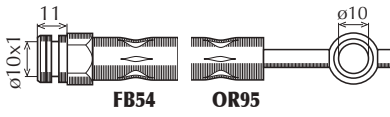
TT	11/00-03/06	<b>80498</b>	▼				5881126020
TT	11/00-03/06	<b>80499</b>	▲				5881126000
TT	11/00-03/06	<b>80500</b>	▼				5881226050
TT	11/00-03/06	<b>80501</b>	▲		505		5881226150

### SANTA FE' II

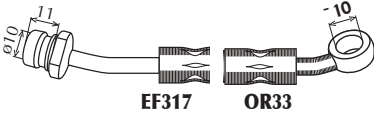
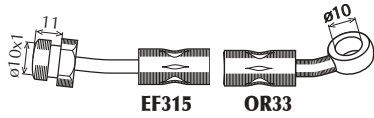
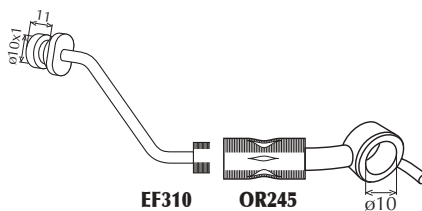
TT	03/06-	<b>80670</b>	▲		390		587312B000
TT	03/06-	<b>80671</b>	▼		390		587322B000
TT	03/06-	<b>80672</b>	▲		410		587372B010

Legenda/Legend: ○ = Intermedio/Intermediate - ● = Interno/Inner - ▲ = Superiore/Upper - ▼ = Inferiore/Lower

## TUBI FLESSIBILI PER FRENO



L



o.e.

### segue SANTA FE' II

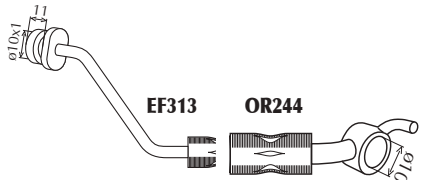
TT	03/06-	80673	▼	410		587382B010
----	--------	-------	---	-----	--	------------

### SONATA II

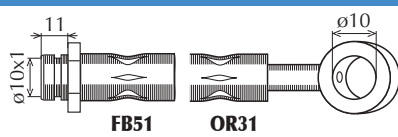
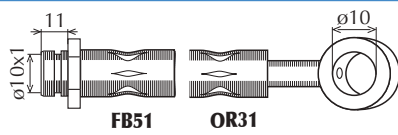
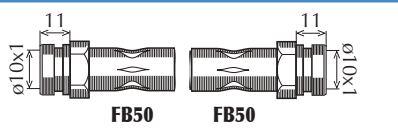
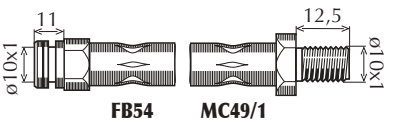
TT (- 3.0 V6)	05/93-06/98	80502	▼	440		5873234001
TT (- 3.0 V6)	05/93-06/98	80503	▲	440		5873134001
TT (- 3.0 V6)	05/93-06/98	80504	◀▶	275		5873734000
3.0 V6	05/93-06/98	80505	◀▶	270		5874438001

### SONATA III

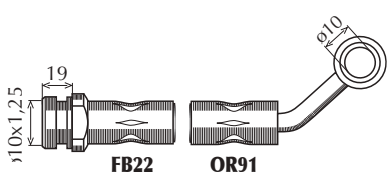
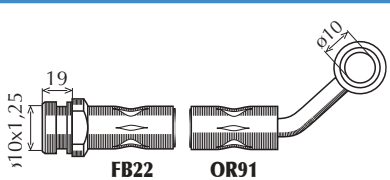
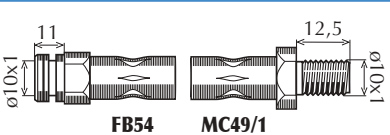
TT	6/98-10/01	80506	▼	715		5873238010
TT	6/98-10/01	80507	▲	715		5873138010
TT	6/98-10/01	80505	◀▶	270		5874438001

### SONATA IV

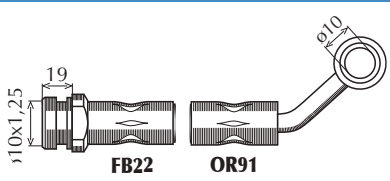
TT	10/01-	80629	▼	715		587323D000
----	--------	-------	---	-----	--	------------

## TUBI FLESSIBILI PER FRENO



L



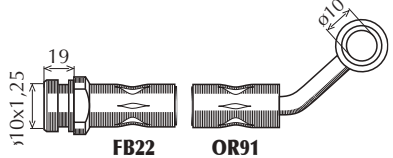
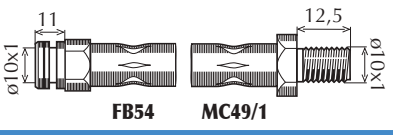
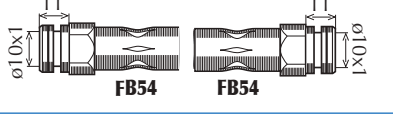
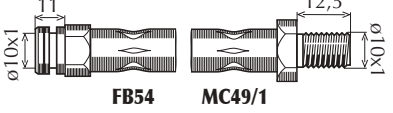

o.e.

### segue SONATA IV

TT	10/01-	<b>80630</b>	▲		715		587313D000
TT (- ABS)	10/01-	<b>80508</b>	▼		265		587443D000
TT (- ABS)	10/01-	<b>80509</b>	▲		260		5873738500
TT (+ ABS)	10/01-	<b>80508</b>	▲▼		265		587443D000

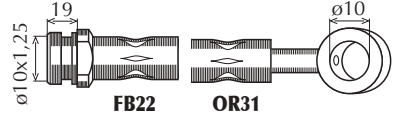
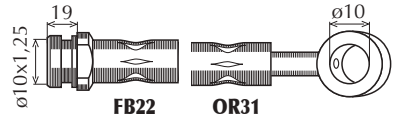
### TERRACAN

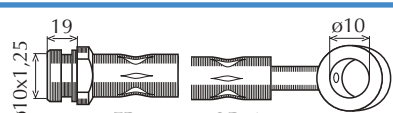
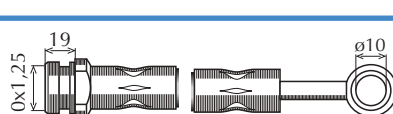
TT	12/01-12/03	<b>80510</b>	▼		440		58734H1000
TT	12/01-12/03	<b>80511</b>	▲		440		58733H1000
TT	12/03-	<b>80512</b>	▼		435		58732H1030
TT	12/03-	<b>80513</b>	▲		435		58731H1030
TT	12/01-	<b>80514</b>	▲▼		265		58834H1060

### TRAJET

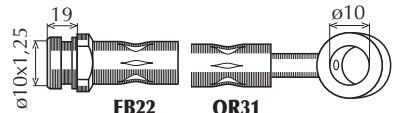
TT	03/00-	<b>80393</b>	▼		485		587323A000
----	--------	--------------	---	--	-----	--	------------

Legenda/Legend: ○ = Intermedio/Intermediate - ● = Interno/Inner - ▲ = Superiore/Upper - ▼ = Inferiore/Lower

## TUBI FLESSIBILI PER FRENO



L



o.e.

### segue TRAJET

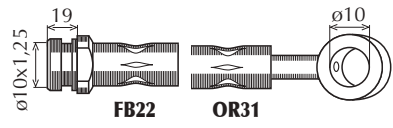
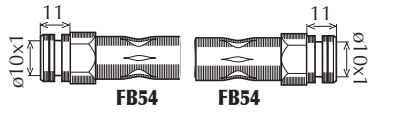
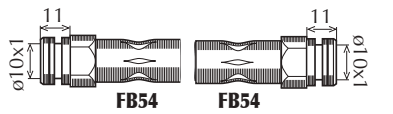
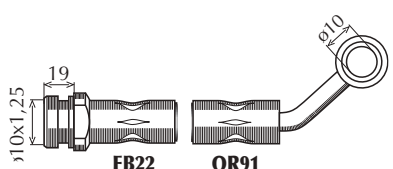
TT	03/00-	80386	▲		485		587313A000
TT (- ABS)	03/00-	80515	◀▶		195		587373A000
TT (Interno)	03/00-	80516	◀▶		220		587443A300
TT (Esterno)	03/00-	80517	◀▶		350		587373A300

### TUCSON

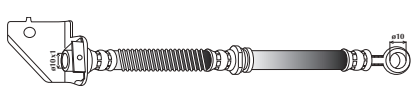
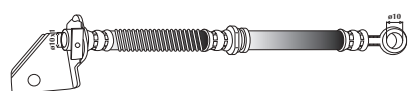
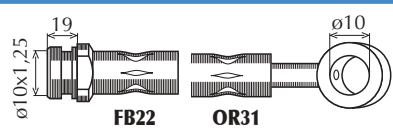
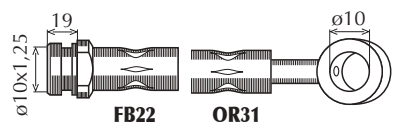
TT	08/04-	80518	▼		440		587322E000
TT	08/04-	80519	▲		440		587312E000
TT (- ABS)	08/04-	80520	◀▶		365		587372E300
TT (+ ABS)	08/04-	80521	◀▶		365		587372E310

### HYUNDAI COMMERCIALI

#### H1

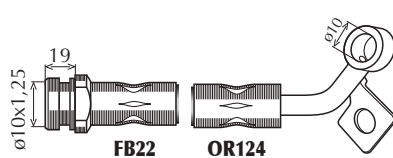
TT	12/99-	80522	▼		340		588114A007
----	--------	-------	---	--	-----	--	------------

## TUBI FLESSIBILI PER FRENO



L



o.e.

### segue H1

TT	12/99-	80523	<		340	<p>FB22 OR103</p>	588114A002
TT	12/99-	80524	>		385	<p>FB54 FB54</p>	588144A001
TT	12/99-	80525	<		360	<p>FB54 FB54</p>	588134A001

### H1 (Mod.2008)



TT	02/08-	80774	<		555	<p>EF314 OR33</p>	587314H000
TT	02/08-	80775	>		555	<p>EF314 OR33</p>	587324H000
TT	02/08-	80776	<		375	<p>EF311 OR249</p>	587374H730
TT	02/08-	80777	>		375	<p>EF309 OR249</p>	587384H730

### H100

TT	7/93-3/00	80526	<>		295	<p>FB50 FB50</p>	5881143002
TT (alla pinza)	7/93-3/00	80527	<>		185	<p>FB50 MC63</p>	5881443003
TT	7/93-3/00	80528	<>		340	<p>FB50 FB50</p>	5881243002

Legenda/Legend: ○ = Intermedio/Intermediate - ● = Interno/Inner - ▲ = Superiore/Upper - ▼ = Inferiore/Lower

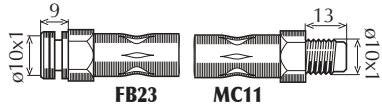
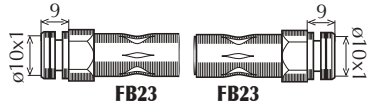
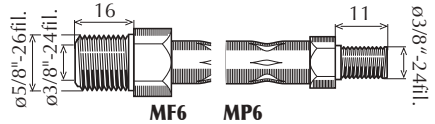
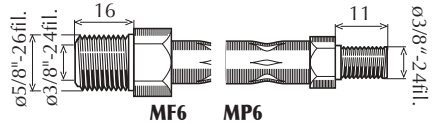
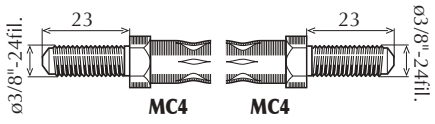
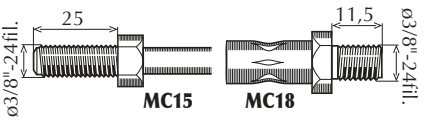
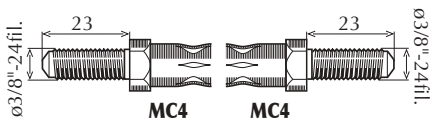
**TUBI FLESSIBILI PER FRENO**

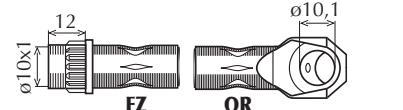
<b>ELBA</b>							
1.3, 1.5, 1.7 DS	90-	<b>8405</b>	<>		390		5995681
1.3, 1.5, 1.7 DS	90-	<b>8406</b>	<>		280		7573858
<b>MINI MINOR - COOPER</b>							
850, 1.0 MK2, MK3, Clubman, Cooper	->12/67	<b>8130</b>	<>		312		39742105
850, 1.0 MK2, MK3, Clubman, Cooper	01/68->	<b>8145</b>	<>		330		38742106
850, 1.0 MK2, MK3, Clubman, Cooper		<b>8131</b>	<>		208		38742113
<b>MINI 90 - 120</b>							
90,120,L,De Tomaso	74-	<b>8146</b>	<>		307		34742105
90,120,L,De Tomaso	74-	<b>8131</b>	<>		208		38742113
<b>MINI TRE - SMALL</b>							
SMALL - 3 Cil./TT	87-	<b>8379</b>	<>		295		557401105
SMALL - 3 Cil./TT	87-	<b>8380</b>	<>		385		557401113

## TUBI FLESSIBILI PER FRENO



o.e.

### Daily-Daily Restyling-TurboDaily 28.8, 30.8, 32.8, 35.8, 35.10, 40.8, 40.10 4x4, 45.10 , 49.10

#### -10/85

T.T. - > CH:27527	-82	8339	<>		535		93800897
T.T. - > CH:27527	-82	8341	<>	<>	460		93803523
T.T. CH:27528->	82-10/85	8340	<>		490		8794797
T.T. CH:27528->	82-10/85	8342	<>	<>	380		8794084

#### 11/85-

30.8, 35.8, 35.10, 40.8 (alla pinza)	11/85-	8451	□		533		8796958
30.8, 35.8, 35.10, 40.8 (interno)	11/85-	8450	●		493		8796885
30.8,35.8,35.10,40.8	11/85-	8624		<>	385		8796934
30.8, 35.8, 35.10, 40.8 (servofreno)	11/85-	8449	◆		327		8796886

### New Daily-New TurboDaily 30.8, 35.8, 35.10, 35.12, 40.8, 45.10, 49.10, 49.12, 59.12

TT (- 59.12)		8623	<>		495		93822393
59.12		8621	<>		535		93817105

Legenda/Legend: ○= Intermedio/Intermediate - ●= Interno/Inner - ▲= Superiore/Upper - ▼= Inferiore/Lower

◆= Servofreno/Brake-servo - □= Pinza/Caliper



**TUBI FLESSIBILI PER FRENO**

**L**

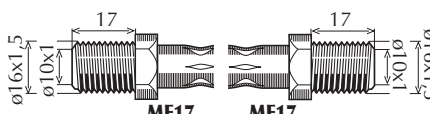
**o.e.**
**segue New Daily-New TurboDaily 30.8, 35.8, 35.10, 35.12, 40.8, 45.10, 49.10, 49.12, 59.12**

TT		<b>8624</b>	<>		385		8796934
TT (servofreno)		<b>8449</b>	◆		327		8796886

**DAILY Heavy Duty 30.8H, 35.8H, 40.8H**

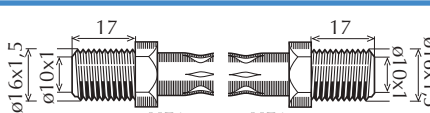
TT		<b>8450</b>	<>		493		8796885
TT (intermedio)		<b>8624</b>	○		385		8796934
TT		<b>8449</b>	<>		327		8796886

**40 NC - 40/35 NC - 50 NC - 55 NC - 80NC, 90NC**
**40 NC - 40/35 NC**

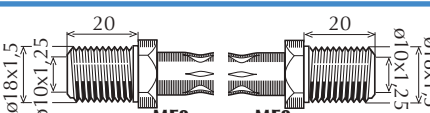
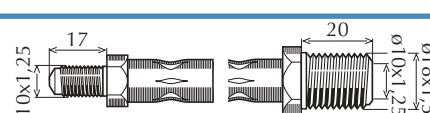
TT		<b>8157</b>	<>		437		8544448
TT (intermedio)		<b>8296</b>	○		320		8544440
TT		<b>8156</b>	<>		495		8536129

**50 NC - 55 NC**

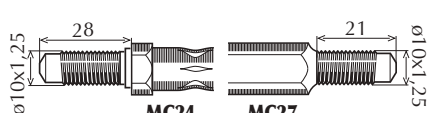
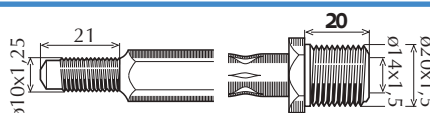
50 NC - 55 NC	-CH:010966	<b>8285</b>	<>		610		8555597
50 NC - 55 NC	CH:010967-	<b>8334</b>	<>		600		8790191

**Legenda/Legend: ○ = Intermedio/Intermediate - ● = Interno/Inner - ▲ = Superiore/Upper - ▼ = Inferiore/Lower**
**◆ = Servofreno/Brake-servo - □ = Pinza/Caliper**



## TUBI FLESSIBILI PER FRENO



L



o.e.

### segue 50 NC - 55 NC

50 NC - 55 NC		8286	<>	397	<p>MC14 OR14</p>	8553147
TT (servofreno)		8335	◆	245	<p>MF9 OR9</p>	8790192

### 80NC, 90NC

TT		8292	<>	510	<p>MF10 MF10</p>	4296604
TT (intermedio)		8294	○	330	<p>MF10 MF10</p>	4291520
TT		8293	<>	487	<p>MF10 MP10</p>	4291513

### 50.8, 50 F8, 50.9, 50 F9, 50.10, 55.8, 55 F8, 55.9, 55 F9 55.10, 55 F10, 60.8, 60.10, 65.10, 65 F10, 70.10, 70.10/1, 70.12, 75.10, 75 F10, 79.10, 79 F10

TT		8334	<>	600	<p>MC27 MF9</p>	8790191
TT		8286	<>	397	<p>MC14 OR14</p>	8553147
50.8, 50.10, 60.10, 79.10		8366	○	850	<p>MC27 MF9</p>	8791112
50.8, 50/55 F8, F9, F10, 60.8, 60.10, 70/75/79 F10, 79.10 (Servofr.)		8336	◆	245	<p>MF9 OR14</p>	8791494

### 79.13 - 80.13 - 90.13 - 90 F13 - 100.13 - 100 F13

79.13, 80/90 F13, 90.13		8344	<>	555	<p>MC30 MF9</p>	8799289
-------------------------	--	------	----	-----	-----------------	---------

Legenda/Legend: ○ = Intermedio/Intermediate - ● = Interno/Inner - ▲ = Superiore/Upper - ▼ = Inferiore/Lower

◆ = Servofreno/Brake-servo - □ = Pinza/Caliper

**TUBI FLESSIBILI PER FRENO**

**L**

**o.e.**
**segue 79.13 - 80.13 - 90.13 - 90 F13 - 100.13 - 100 F13**

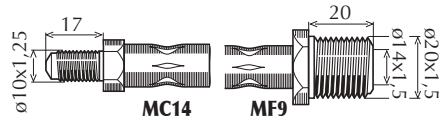
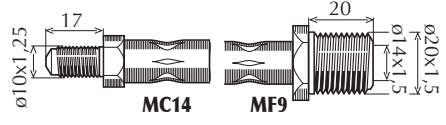
100.13 - 100 F13		8306	<>		600		8789706
T.T.		8307	<>		495		8789297

**79.14 - 79.14 Zeta - 95.14 - 95.14 Zeta - 109.14 - 109.14 Zeta**

TT		8286	<>		397		8553147
----	--	------	----	--	-----	--	---------

**100 NC - 110 NC**

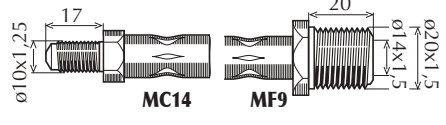
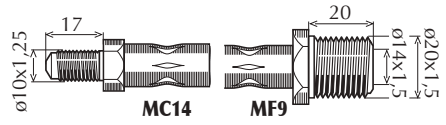
TT		8288	<>		590		4294438
TT		8288	<>		590		4294438

**120 F13 - 120 F14**

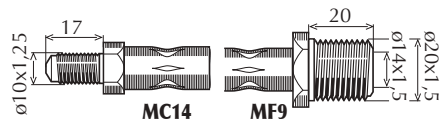
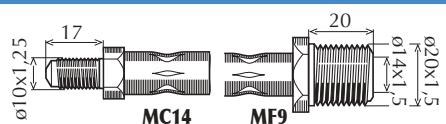
TT		8288	<>		590		4294438
TT		8288	<>		590		4294438

**150 F14 - 150.17**

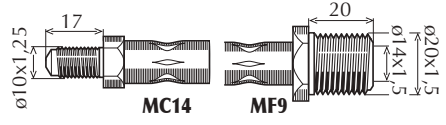
T.T.		8288	<>		590		4294438
------	--	------	----	--	-----	--	---------

**Legenda/Legend:** ○ = Intermedio/Intermediate - ● = Interno/Inner - ▲ = Superiore/Upper - ▼ = Inferiore/Lower

**◆ = Servofreno/Brake-servo - □ = Pinza/Caliper**

## TUBI FLESSIBILI PER FRENO



o.e.

### GAMMA OM

### OM - 65 - 70 - 80 - 90

#### 50 - 55

TT	-CH:010220	8285	<>		610		8555597
TT	CH:010221-	8334	<>		600		8790191
TT		8286	<>		397		8553147
TT (servofreno)		8335	◆		245		8790192

#### 65 - 70

TT	-ch:009553	8300	<>		640		8553080
TT	ch:009554-	8348	<>		630		8790418
TT		8286	<>		397		8553147
TT (servofreno)	-ch:009553	8302	◆		270		8553343
TT (servofreno)	ch:009554-	8335	◆		245		8790192

#### 80 - 90

TT		8298	<>		505		4294700
----	--	------	----	--	-----	--	---------

Legenda/Legend: ○= Intermedio/Intermediate - ●= Interno/Inner - ▲= Superiore/Upper - ▼= Inferiore/Lower

◆= Servofreno/Brake-servo - □= Pinza/Caliper

**TUBI FLESSIBILI PER FRENO**

**o.e.**
**segue GAMMA OM**
**OM - 65 - 70 - 80 - 90**
**segue 80 - 90**

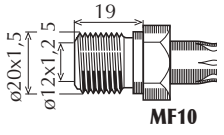
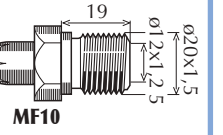
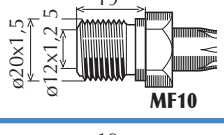
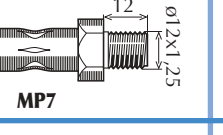
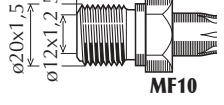
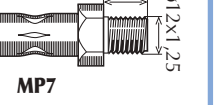
TT (intermedio)		8294	○	330	 MF10	 MF10	4291520
80		8299	<>	517	 MF10	 MP7	4291517
90		8293	<>	487	 MF10	 MP7	4291513

**OM 100 - 100 N - 110 - 120 - 130**
**100 - 110 - 130**

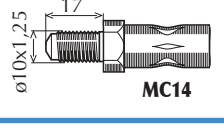
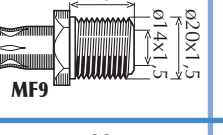
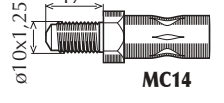
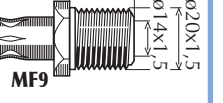
TT		8288	<>	590	 MC14	 MF9	4294438
TT		8288	<>	590	 MC14	 MF9	4294438

**100 N**

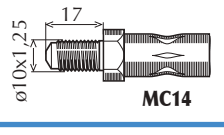
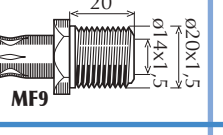
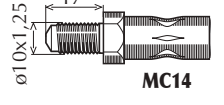
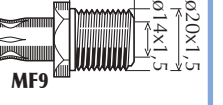
TT		8306	<>	600	 MC14	 MF9	8789706
TT		8307	<>	495	 MC14	 MF9	8789297

**120**

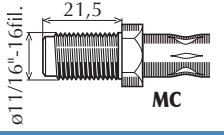
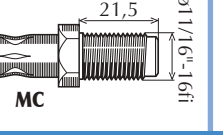
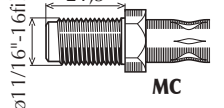
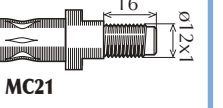
TT		8001	<>	470	 MC	 MC	4097914
TT		8276	<>	545	 MC	 MC21	8546859

**Legenda/Legend: ○= Intermedio/Intermediate - ●= Interno/Inner - ▲= Superiore/Upper - ▼= Inferiore/Lower**
**◆= Servofreno/Brake-servo - □= Pinza/Caliper**

## TUBI FLESSIBILI PER FRENO



L



o.e.

### OM CERBIATTO - DAINO - LEONCINO

#### Leoncino (CO1D)

TT		8000	<>		420		8513119
TT		8000	<>		420		8513119

#### Cerbiatto - Daino - Leoncino (CO2D)

TT		8063	<>		455		4086648
TT		8064	<>		495		4085611

#### Cerbiatto - Daino - Leoncino (CO3)

TT		8277	<>		450		8546589
TT		8278	<>		495		8546590

### OM LUPETTO

TT		8156	<>		495		8536129
TT		8156	<>		495		8536129

### OM ORSETTO

TT		8157	<>		437		8544448
TT		8156	<>		495		8536129

Legenda/Legend: ○ = Intermedio/Intermediate - ● = Interno/Inner - ▲ = Superiore/Upper - ▼ = Inferiore/Lower

◆ = Servofreno/Brake-servo - □ = Pinza/Caliper

**TUBI FLESSIBILI PER FRENO**

**L**

**o.e.**
**OM TIGROTTO**
**Tigrotto (CO1D)**

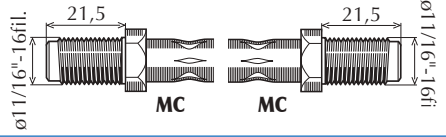
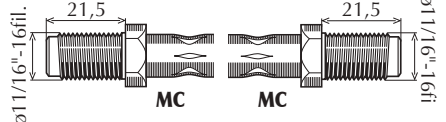
TT		8000	<>		420		8513119
TT		8000	<>		420		8513119

**Tigrotto (CO2D)**

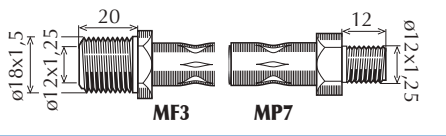
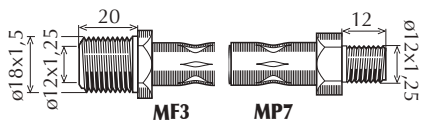
TT		8063	<>		455		4086648
TT		8064	<>		495		4085611

**Tigrotto (CO3)**

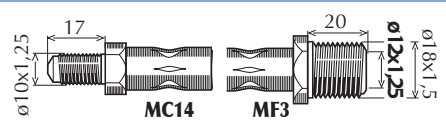
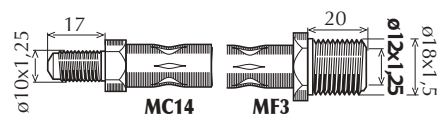
TT		8277	<>		450		8546589
TT		8278	<>		495		8546590

## TUBI FLESSIBILI PER FRENO



L



o.e.

### CHEROKEE (XJ)

TT	09/90-	80031	▼		460		52008674
TT	09/90-	80032	▲		460		52008675
TT	09/90-	80033	<>		350		52007562

### CHEROKEE (KJ)

TT	09/01-	81045	▲				52128311AB
TT	09/01-	81046	▼				52128312AB

### CHEROKEE (KK)

TT	01/08-	81047	▲				52125333AB
TT	01/08-	81048	▼				52125334AB

### GRAN CHEROKEE

TT	09/91-04/99	80031	▼		460		52008674
TT	09/91-04/99	80032	▲		460		52008675

Legenda/Legend: ○ = Intermedio/Intermediate - ● = Interno/Inner - ▲ = Superiore/Upper - ▼ = Inferiore/Lower

## TUBI FLESSIBILI PER FRENO



L



o.e.

### WILLYS

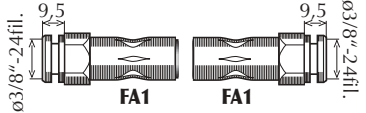
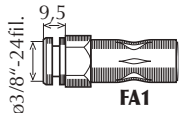
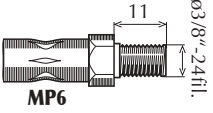
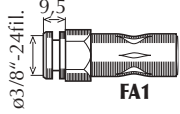
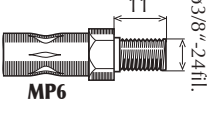
TT		<b>8100</b>	<>		180		5995681
TT		<b>8101</b>	<>		295	 	7573858
TT		<b>8102</b>	<>		405	 	7573859

### WRANGLER

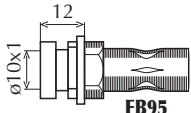
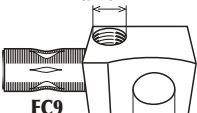
2.5, 4.0	12/91-08/96	<b>80034</b>	>		510	<p>Il disegno non è disponibile The drawing is not available</p>	52008778
2.5, 4.0	12/91-08/96	<b>80035</b>	<		510	<p>Il disegno non è disponibile The drawing is not available</p>	52008779
2.5, 4.0	12/91-08/96	<b>80036</b>	<>		420	 	52004152



## TUBI FLESSIBILI PER FRENO



L



o.e.

### CARENS I

TT	11/00-07/02	<b>80151</b>	<>	537		K2A243810C
----	-------------	--------------	----	-----	--	------------

### CARENS II

TT	07/02-	<b>80151</b>	<>	537		K2A243810C
----	--------	--------------	----	-----	--	------------

### CARENS III

TT	09/06-	<b>80778</b>	▲	485		587311D000
TT	09/06-	<b>80779</b>	▼	485		587321D000
TT	09/06-	<b>80780</b>	▲	285		587371D000
TT	09/06-	<b>80781</b>	▼	290		587381D000

### CARNIVAL I

TT	08/99-10/01	<b>80529</b>	▼	545		OK55243980C
TT	08/99-10/01	<b>80530</b>	▲	545		OK55243990B
TT	08/99-10/01	<b>80531</b>	<>	290		OK55243820C

Legenda/Legend: ○ = Intermedio/Intermediate - ● = Interno/Inner - ▲ = Superiore/Upper - ▼ = Inferiore/Lower

## TUBI FLESSIBILI PER FRENO





o.e.

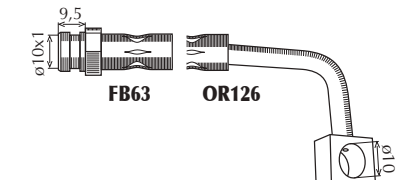
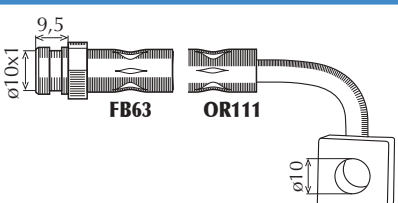
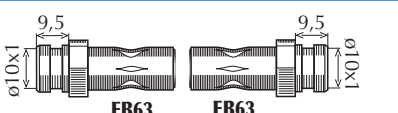

### CARNIVAL II

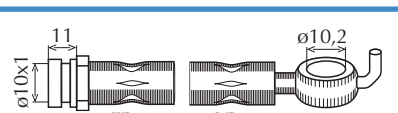
TT	10/01-	80529	▼		545		OK55243980C
TT	10/01-	80530	▲		545		OK55243990B
TT	10/01-	80531	◀▶		290		OK55243820C

### CEE'D - PRO CEE'D

TT	12/06-	80782	▲		535		587311M000
TT	12/06-	80783	▼		535		587321M000
TT	12/06-	80784	▲		310		587371H300
TT	12/06-	80785	▼		310		587371H500

### CERATO

TT	03/04-	80982	▲				587302F000
TT	03/04-	80983	▼				587402F000
TT	03/04-	80984	◀▶		500		587372F100

## TUBI FLESSIBILI PER FRENO



L



o.e.

### CLAURUS I-II

TT	07/96-	80532	< >		415	<p>FB67 MC62</p>	OK9A243980A
----	--------	-------	-----	--	-----	------------------	-------------

### MAGENTIS

TT	05/01-	80533	>		700		587322G000
TT	05/01-	80534	<		550		587312G000
TT	05/01-	80535	>		290		587452G000
TT	05/01-	80536	<		290		587442G000

### PICANTO

TT	04/04-	80640	< >			<p>FB22 OR31</p>	5873107000
TT (- ABS)	04/04-	80641	< >			<p>FB22</p>	5873707000
TT (+ ABS)	04/04-	80642	>		485	<p>FB98 OR170</p>	5873807300
TT (+ ABS)	04/04-	80643	<		485	<p>FB98 OR224</p>	5873707300

**TUBI FLESSIBILI PER FRENO**

**L**

**o.e.**
**RIO**

TT	08/00-02/05	<b>80786</b>	<>			Il disegno non è disponibile The drawing is not available	OK30A43810A
TT	08/00-02/05	<b>80787</b>	<>		460	 <b>FB67</b> <b>OR52</b>	OK30A43980E

**RIO II**

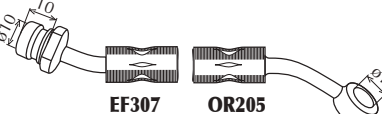
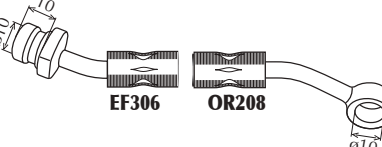
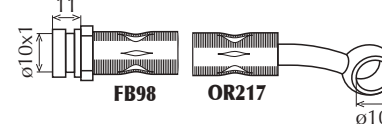
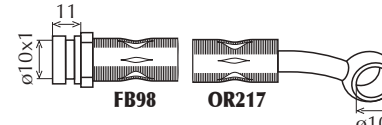
TT	03/05-	<b>80788</b>	<		545	 <b>EF307</b> <b>OR205</b>	587311G000
TT	03/05-	<b>80789</b>	>		545	 <b>EF306</b> <b>OR208</b>	587321G000
TT	03/05-	<b>80772</b>	<		505	 <b>FB98</b> <b>OR217</b>	587371G300
TT	03/05-	<b>80773</b>	>		505	 <b>FB98</b> <b>OR217</b>	587381G300

**RIO III**

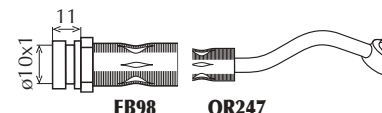
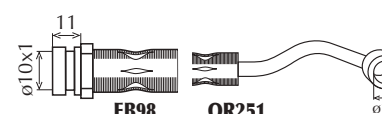
TT	09/11-	<b>81049</b>	<		560	 <b>FB98</b> <b>OR247</b>	587311W000
TT	09/11-	<b>81050</b>	>		555	 <b>FB98</b> <b>OR251</b>	587321W000
TT	09/11-	<b>81051</b>	<>			Il disegno non è disponibile The drawing is not available	587371W000

## TUBI FLESSIBILI PER FRENO



L



o.e.

### SEPHIA

TT	01/95-	<b>80149</b>	<>		490		K20143980B
TT (- ABS)	01/95-	<b>80150</b>	<>		300		K20143810C
TT (+ ABS)	01/95-	<b>80151</b>	<>		537		K2A243810C

### SHUMA

TT	10/97-	<b>80149</b>	<>		490		K20143980B
TT (+ ABS)	10/97-	<b>80151</b>	<>		537		K2A243810C

### SORENTO I

TT	08/02-05/06	<b>80917</b>	<		700		587313E100
TT	08/02-05/06	<b>80918</b>	>		700		587323E100
TT	08/02-05/06	<b>80676</b>	<		255		587373E100
TT	08/02-05/06	<b>80677</b>	>		255		587383E100

### SORENTO II

TT	05/06-10/09	<b>80674</b>	<		700		587313E200
----	-------------	--------------	---	--	-----	--	------------

## TUBI FLESSIBILI PER FRENO



L



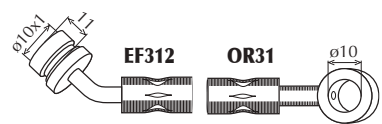
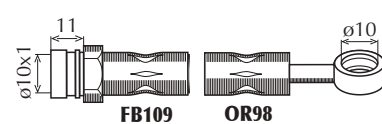

o.e.

### segue SORENTO II

TT	05/06-10/09	<b>80675</b>	▼		700		587323E200
TT	05/06-10/09	<b>80919</b>	◀▶		235		587373E000

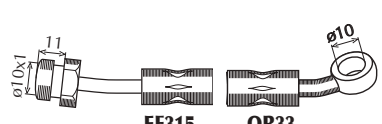
### SORENTO III

TT	11/09-	<b>80670</b>	▲		390		587312B000
TT	11/09-	<b>80671</b>	▼		390		587322B000
TT	11/09-	<b>80672</b>	▲		410		587372B010
TT	11/09-	<b>80673</b>	▼		410		587382B010

### SOUL

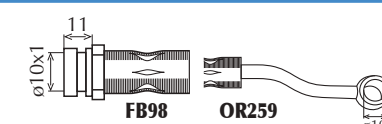
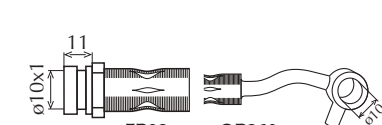
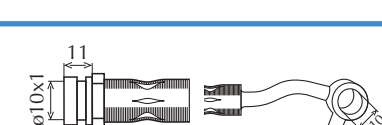
TT	02/09-	<b>80790</b>	▼			Il disegno non è disponibile The drawing is not available	587312K000
TT	02/09-	<b>80791</b>	▲		540		587322K000
TT	02/09-	<b>80792</b>	▲		195		587472K500
TT	02/09-	<b>80793</b>	▼		195		587482K500

## TUBI FLESSIBILI PER FRENO



L



o.e.

### SPORTAGE I

TT	96-	80152	▼		400		K01143810B
TT	96-	80153	▲		400		K01143830B
TT	96-	80154	<>		353		K01143820



### SPORTAGE III

TT	07/10-	80913	▲		555		587312S100
TT	07/10-	80914	▼		555		587322S100
TT	07/10-	80915	▲		345		587372S100
TT	07/10-	80916	▼		345		587382S100

**TUBI FLESSIBILI PER FRENO**

**L**

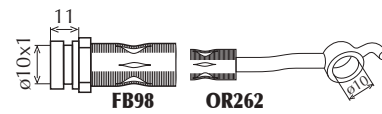
**o.e.**
**VENGA**

TT	02/10-	<b>80794</b>	<		575		587311P000
TT	02/10-	<b>80795</b>	>			<p>Il disegno non è disponibile The drawing is not available</p>	587321P000
TT	02/10-	<b>80796</b>	<				587371P300
TT	02/10-	<b>80797</b>	>			<p>Il disegno non è disponibile The drawing is not available</p>	587381P300



## TUBI FLESSIBILI PER FRENO



L



o.e.

### 1200, 1300, 1500, 1600 (2101, 2102, 2103)

TT	74-86	8327	<>		285		2101-3506060
TT	74-86	8019	<>		295		2101-3506085

### NIVA (2121)

TT	77-95	8526	>		450		2121-3506060
TT	77-95	8527	<		493		2111-3506061
TT	77-95	8019	<>		295		2101-3506085

### NOVA (2104, 2105)

TT	74-86	8327	<>		285		2101-3506060
TT	74-86	8019	<>		295		2101-3506085

### SAMARA (2108)

TT	86-	8509	<>		340		2108-3506060
TT	86-	8511	<>		260		2108-3506085

**TUBI FLESSIBILI PER FRENO**

**L**

**o.e.**
**A112**
**-02/82**

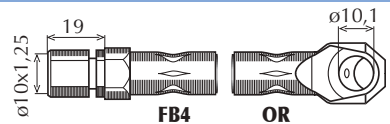
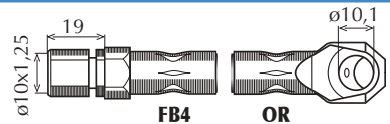
TT	-02/82	<b>8320</b>	<>		300		82422135
TT	-02/82	<b>8269</b>	<>		265		7593342

**03/82-87**

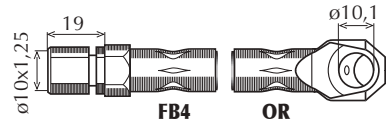
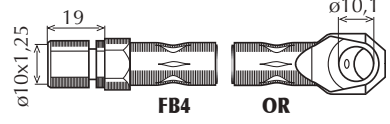
TT	03/82->87	<b>8266</b>	<>		300		4253987
TT	03/82->87	<b>8327</b>	<>		285		4188755

**APPIA II**

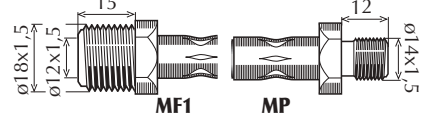
TT		<b>8032</b>	<>		450		2191285
TT		<b>8032</b>	<>		450		2191285

**BETA**

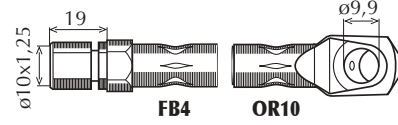
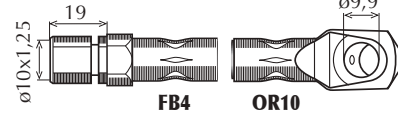
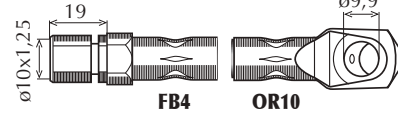
TT	06/73-85	<b>8303</b>	<>		490		82289850
TT (Doppio Circuito)	06/73-85	<b>8304</b>	<>		490		82289851
TT	06/73-85	<b>8305</b>	<>		370		82286931

## TUBI FLESSIBILI PER FRENO



o.e.

### DEDRA

#### -06/94 ( excl. Turbo & 4WD)

1.6 (- ABS) (-CH: 4014292)	-02/93	<b>8403</b>	<>		390		82289850
1.6 (- ABS) (CH:4014293->)	02/93-06/94	<b>8415</b>	<>		405		7655156
1.6 (+ ABS), 1.8, 2.0, 1.9 TD	-06/94	<b>8415</b>	<>		405		7655156
1.6, 1.8 (+ ABS) (intermedio)	-02/93	<b>8417</b>		○	240		7667806
1.6, 1.8 (+ ABS) (intermedio)	02/93-06/94	<b>8486</b>		○	245		7670215
1.8,2.0,1.9 TD (- ABS) (intermedio)	-06/94	<b>8417</b>		○	240		7667806
2.0, 1.9 TD (+ ABS) (intermedio)	-06/94	<b>8486</b>		○	245		7670215
1.6 (- ABS)	-06/94	<b>8417</b>	<>		240		7667806
1.6, 1.8, 2.0, 1.9 TD (+ ABS)	-06/94	<b>8459</b>	<>		182		7586907
1.8,2.0,1.9 TD (- ABS)	-06/94	<b>8489</b>	<>		210		7614669



#### 07/94-07/99 ( excl. Turbo & 4WD)

1.6 8V, 1.8 8V, 2.0 8V (FL 94)	07/94-11/96	<b>8403</b>	>		390		82289850
-----------------------------------	-------------	-------------	---	--	-----	--	----------

Legenda/Legend: ○ = Intermedio/Intermediate - ● = Interno/Inner - ▲ = Superiore/Upper - ▼ = Inferiore/Lower

**TUBI FLESSIBILI PER FRENO**

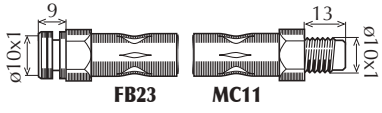
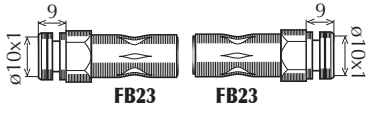
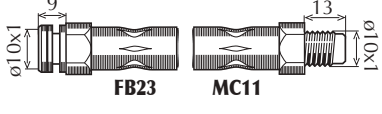
**o.e.**
**segue DEDRA**
**segue 07/94-07/99 ( excl. Turbo & 4WD)**

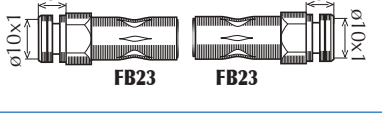
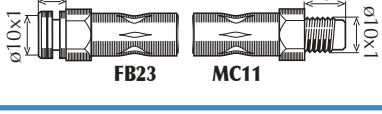
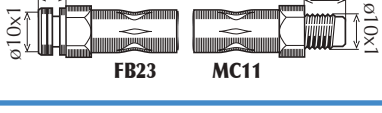
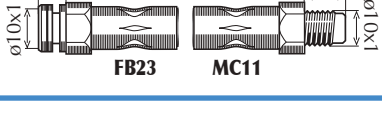
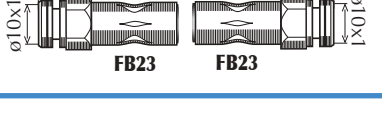
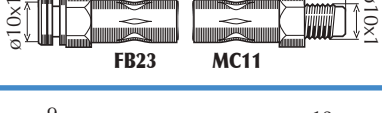
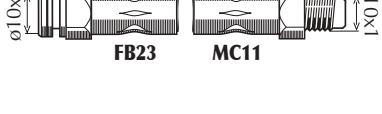
1.6 8V, 1.8 8V, 2.0 8V (FL 94)	07/94-11/96	<b>8415</b>	▲		405		7655156
1.6 8V, 1.8 8V, 2.0 8V (FL 94) (intermedio)	07/94-11/96	<b>8417</b>		○	240		7667806
1.6 8V, 1.8 8V, 2.0 8V (FL 94)	07/94-11/96	<b>8459</b>		◁ ▷	182		7586907
1.6 16V, 1.9 TD (FL 94)	01/96-07/99	<b>8553</b>		◁ ▷	435		46448592
1.6 16V, 1.9 TD (FL 94) (intermedio)	01/96-07/99	<b>8417</b>		○	240		7667806
1.6 16V, 1.9 TD (FL 94)	01/96-07/99	<b>8459</b>		◁ ▷	182		7586907
1.8 16V 115 CV (FL 94)	11/95-07/99	<b>8552</b>		▼	415		7674977
1.8 16V 115 CV (FL 94)	11/95-07/99	<b>8415</b>		▲	405		7655156
1.8 16V 115 CV (FL 94) (intermedio)	11/95-07/99	<b>8417</b>		○	240		7667806
1.8 16V 115 CV (FL 94)	11/95-07/99	<b>8459</b>		◁ ▷	182		7586907
1.8 16V 132 CV (FL 94)	11/95-07/99	<b>8552</b>		◁ ▷	415		7674977

**Legenda/Legend: ○ = Intermedio/Intermediate - ● = Interno/Inner - ▲ = Superiore/Upper - ▼ = Inferiore/Lower**





## TUBI FLESSIBILI PER FRENO

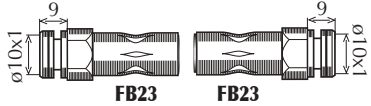
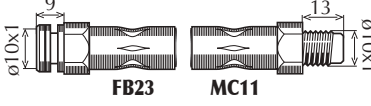
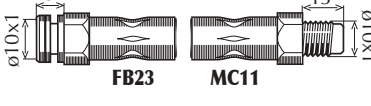
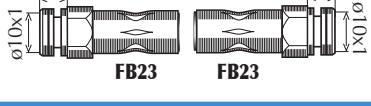

**o.e.**

### segue DEDRA

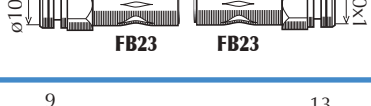
#### segue 07/94-07/99 ( excl. Turbo & 4WD)

1.8 16V 132 CV (FL 94) (intermedio)	11/95-07/99	<b>8486</b>		○	245		7670215
1.8 16V 132 CV (FL 94)	11/95-07/99	<b>8459</b>		<>	182		7586907
2.0 16V (FL 94) (- ABS)	07/94-07/99	<b>8436</b>		<>	435		7729198
2.0 16V (FL 94) (- ABS) (intermedio)	07/94-07/99	<b>8417</b>		○	240		7667806
2.0 16V (FL 94) (- ABS)	07/94-07/99	<b>8459</b>		<>	182		7586907
2.0 16V (FL 94) (+ ABS)	07/94-07/99	<b>8415</b>		<>	405		7655156
2.0 16V (FL 94) (+ ABS) (intermedio)	07/94-07/99	<b>8486</b>		○	245		7670215
2.0 16V (FL 94) (+ ABS)	07/94-07/99	<b>8459</b>		<>	182		7586907

### Turbo

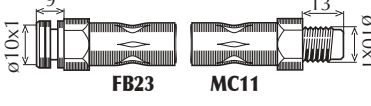
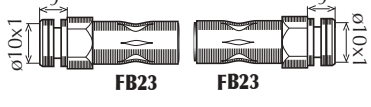
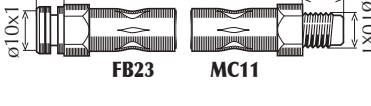
2.0 Turbo	04/91-07/99	<b>8415</b>		<>	405		7655156
2.0 Turbo (- ABS) (intermedio)	04/91-07/99	<b>8417</b>		○	240		7667806
2.0 Turbo (- ABS)	04/91-07/99	<b>8459</b>		<>	182		7586907

Legenda/Legend: ○ = Intermedio/Intermediate - ● = Interno/Inner - ▲ = Superiore/Upper - ▼ = Inferiore/Lower

**TUBI FLESSIBILI PER FRENO**

**o.e.**
**segue DEDRA**
**segue Turbo**

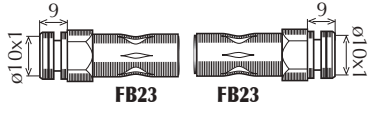
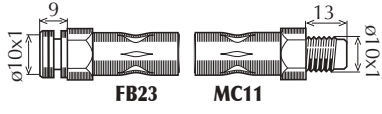
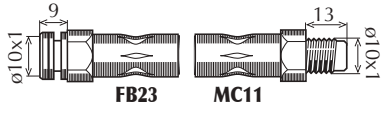
2.0 Turbo (+ ABS) (intermedio)	04/91-07/99	<b>8486</b>		○	245		7670215
2.0 Turbo (+ ABS)	04/91-07/99	<b>8382</b>		<>	210		7563845
2.0 Turbo (+ ABS)	04/91-07/99	<b>8459</b>		<>	182		7586907

**Turbo 4WD**

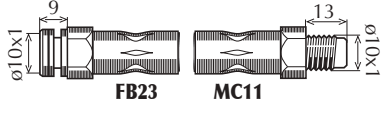
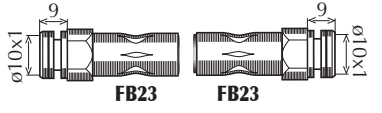
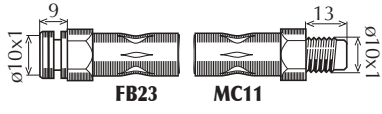
2.0 Turbo 4WD	04/91-07/99	<b>8415</b>		<>	405		7655156
2.0 Turbo 4WD (intermedio)	04/91-07/99	<b>8417</b>		○	240		7667806
2.0 Turbo 4WD	04/91-07/99	<b>8382</b>		<>	210		7563845

**DELTA**
**-02/93**

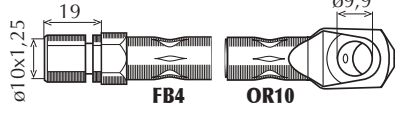
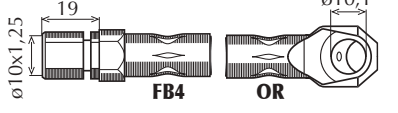
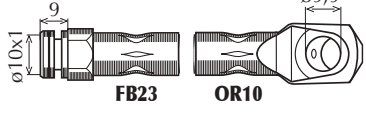
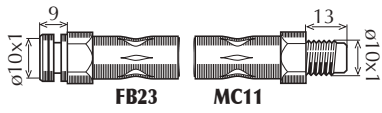
1.3, 1.5	-10/82	<b>8321</b>		<>	465		82347696
1.3, 1.5	-10/82	<b>8322</b>		<>	380		82353829
1.3, 1.5	11/82-02/93	<b>8372</b>		<>	460		82397551
1.3, 1.5	11/82-06/86	<b>8355</b>		<>	421		5986578

## TUBI FLESSIBILI PER FRENO



**o.e.**

### segue DELTA

#### segue -02/93

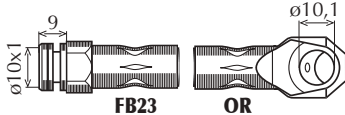
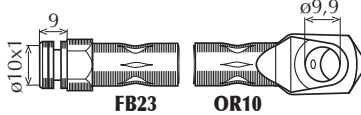
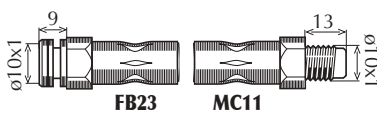
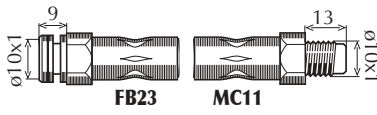
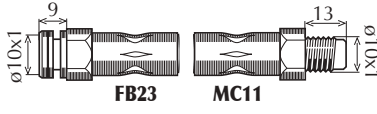
1.3, 1.5	07/86-02/93	<b>8373</b>	<>	410		82392239
1.6 GT	11/82-04/86	<b>8372</b>	<>	460		82397551
1.6 GT	11/82-04/86	<b>8375</b>	<>	460		82393405
1.6 GT ie, HF Turbo	10/83-02/93	<b>8371</b>	<>	487		82393404
1.6 GT ie, HF Turbo	10/83-02/93	<b>8375</b>	<>	460		82393405

#### 03/93-

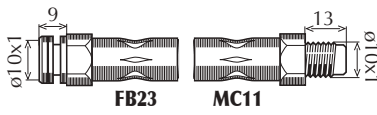
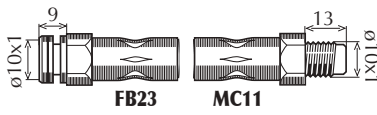
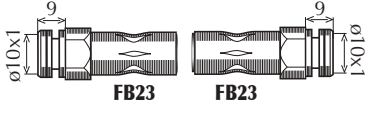
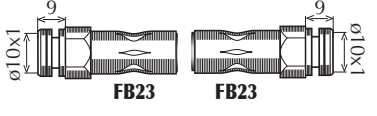
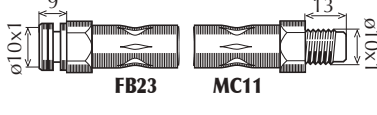
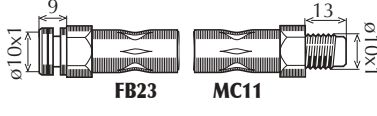
1.6ie (mod. 93)	03/93-08/99	<b>8403</b>	▼	390		82289850
1.6ie (mod. 93) (- ABS)	03/93-08/99	<b>8415</b>	▲	405		7655156
1.6ie (mod. 93) (- ABS)	03/93-08/99	<b>8417</b>	<>	240		7667806
1.6ie (mod. 93) (+ ABS) (intermedio)	03/93-08/99	<b>8486</b>	○	245		7670215
1.6ie (mod. 93) (+ ABS)	03/93-08/99	<b>8459</b>	<>	182		7586907
1.6 16V (mod. 93)	01/96-08/99	<b>8552</b>	<>	415		7674977

Legenda/Legend: ○ = Intermedio/Intermediate - ● = Interno/Inner - ▲ = Superiore/Upper - ▼ = Inferiore/Lower

**TUBI FLESSIBILI PER FRENO**

**L**

**o.e.**
**segue DELTA**
**segue 03/93-**

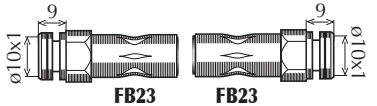
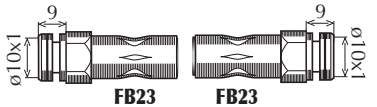
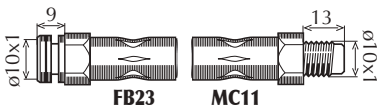
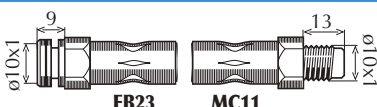
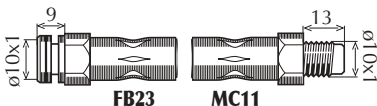
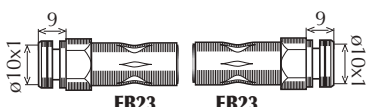
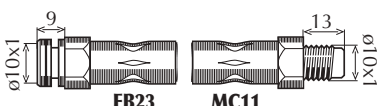
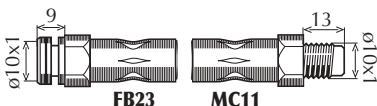
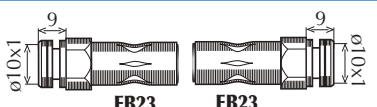
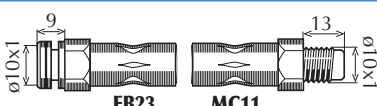
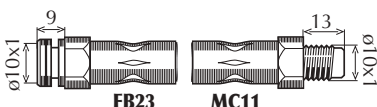
1.6 16V (mod. 93) (- ABS)	01/96-08/99	<b>8417</b>		<>	240		7667806
1.6 16V (mod. 93) (+ ABS) (intermedio)	01/96-08/99	<b>8486</b>		○	245		7670215
1.6 16V (mod. 93) (+ ABS)	01/96-08/99	<b>8459</b>		<>	182		7586907
1.8ie (mod. 93) (- ABS)	03/93-08/99	<b>8403</b>		▼	390		82289850
1.8ie (mod. 93) (- ABS)	03/93-08/99	<b>8415</b>		▲	405		7655156
1.8ie (mod. 93) (- ABS) (intermedio)	03/93-08/99	<b>8417</b>		○	240		7667806
1.8ie (mod. 93) (- ABS)	03/93-08/99	<b>8459</b>		<>	182		7586907
1.8ie (mod. 93) (+ ABS)	03/93-08/99	<b>8415</b>		<>	405		7655156
1.8ie (mod. 93) (+ ABS) (intermedio)	03/93-08/99	<b>8486</b>		○	245		7670215
1.8ie (mod. 93) (+ ABS)	03/93-08/99	<b>8459</b>		<>	182		7586907
1.8 16V 115 CV (mod. 93)	03/96-08/99	<b>8552</b>		<>	415		7674977



## TUBI FLESSIBILI PER FRENO







L

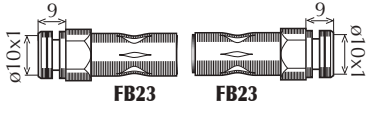
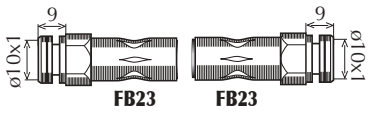
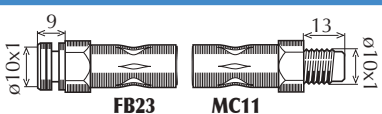
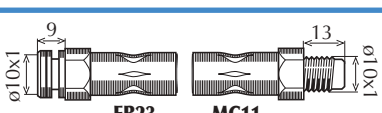

o.e.

### segue DELTA

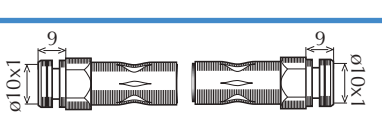
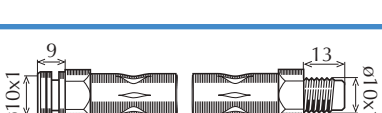
#### segue 03/93-

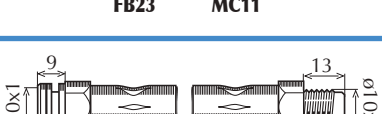
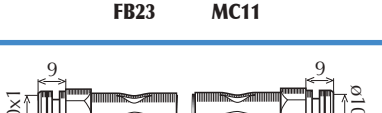
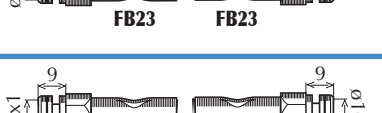
1.8 16V 115 CV (mod. 93) (- ABS) (intermedio)	03/96-08/99	<b>8417</b>		○	240		7667806
1.8 16V 115 CV (mod. 93) (+ ABS) (intermedio)	03/96-08/99	<b>8486</b>		○	245		7670215
1.8 16V 115 CV (mod. 93)	03/96-08/99	<b>8459</b>		<>	182		7586907
1.8 16V 132 CV (mod. 93)	03/96-08/99	<b>8553</b>	<>		435		46448592
1.8 16V 132 CV (mod. 93) (- ABS) (intermedio)	03/96-08/99	<b>8417</b>		○	240		7667806
1.8 16V 132 CV (mod. 93) (+ ABS) (intermedio)	03/96-08/99	<b>8486</b>		○	245		7670215
1.8 16V 132 CV (mod. 93)	03/96-08/99	<b>8459</b>		<>	182		7586907
1.9 TD (mod. 93)	-10/95	<b>8436</b>	<>		435		7729198
1.9 TD (mod. 93)	10/95-08/99	<b>8553</b>	<>		435		46448592
1.9 TD (mod. 93) (- ABS) (intermedio)	06/93-08/99	<b>8417</b>		○	240		7667806
1.9 TD (mod. 93) (+ ABS) (intermedio)	06/93-08/99	<b>8486</b>		○	245		7670215



Legenda/Legend: ○ = Intermedio/Intermediate - ● = Interno/Inner - ▲ = Superiore/Upper - ▼ = Inferiore/Lower

**TUBI FLESSIBILI PER FRENO**

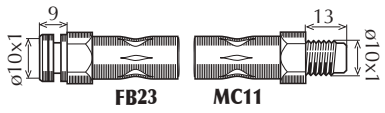
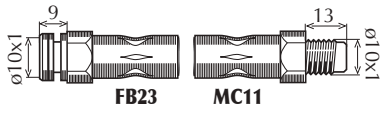
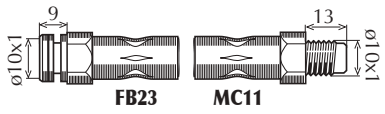
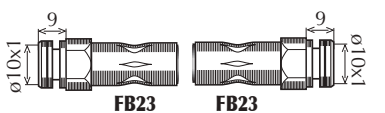
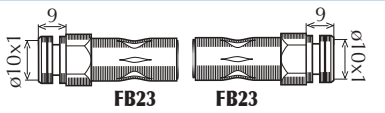
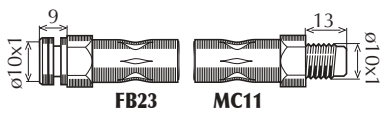
**o.e.**
**segue DELTA**
**segue 03/93-**

1.9 TD (mod. 93)	06/93-08/99	<b>8459</b>	<>	<>	182		7586907
2.0 16V Turbo	06/93-06/95	<b>8436</b>	<>	<>	435		7729198
2.0 16V Turbo	06/95-08/99	<b>8553</b>	<>	<>	435		46448592
2.0 16V Turbo (- ABS) (intermedio)	06/93-08/99	<b>8417</b>		○	240		7667806
2.0 16V Turbo (+ ABS) (intermedio)	06/93-08/99	<b>8486</b>		○	245		7670215
2.0 16V Turbo	06/93-08/99	<b>8459</b>	<>	<>	182		7586907

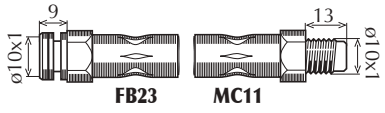
**DELTA (Mod. 2008)**

TT	09/08-	<b>8917</b>	<>	<>	435		46554126
TT	09/08-	<b>80335</b>	<>	<>	210		51783802

**FULVIA**

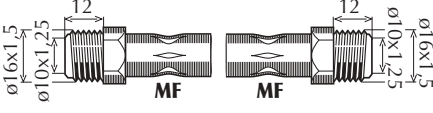
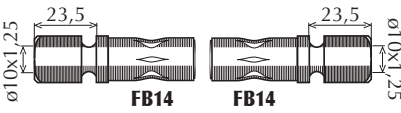
TT	-1969	<b>8059</b>	<>	<>	450		82191288
TT	1970-	<b>8271</b>	<>	<>	380		82277943

TUBI FLESSIBILI PER FRENO



L



o.e.

segue FULVIA

TT	1970-	8272	<>		430			82277944
TT	-1969	8060	<>		450			82167018
TT	1970-	8273	<>		430			82277945

KAPPA

TT	08/94-02	8574	<>		565			82483020
TT	08/94-02	8401	<>		407			82422142

LYBRA

TT	07/99-	8554	<>		435			46454003
TT	07/99-	8926	<>		330			46738559

MUSA

TT	10/04-	80184	<>		476			51767150
TT	01/04-	8265	<>		195			46542040
1.6 JTD (120 CV) (Alla pinza)	2008-	8611	<>		245			82442878

Legenda/Legend: ○ = Intermedio/Intermediate - ● = Interno/Inner - ▲ = Superiore/Upper - ▼ = Inferiore/Lower



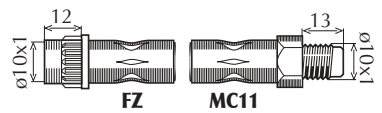
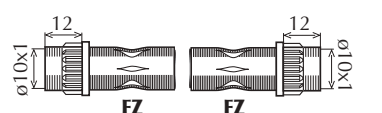

**TUBI FLESSIBILI PER FRENO**

**L**

**o.e.**
**PHEDRA**

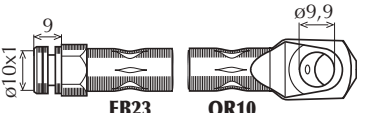
TT (- 3.0 V6)	09/02-	<b>80007</b>	<>		490		1484536080
TT	09/02-	<b>8573</b>	<>		275		480667

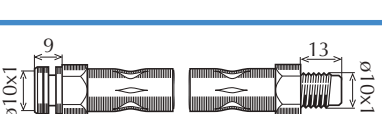
**PRISMA**

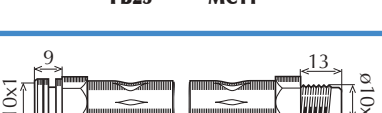
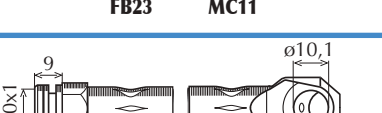
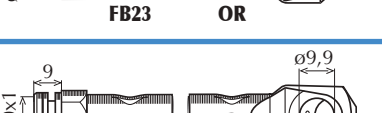
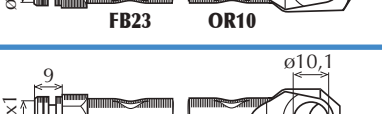
1.3, 1.5	01/83-02/92	<b>8372</b>	<>		460		82397551
1.3, 1.5	01/83-02/92	<b>8373</b>	<>		410		82392239
1.6	01/83-02/92	<b>8371</b>	<>		487		82393404
1.6	01/83-02/92	<b>8375</b>	<>		460		82393405
1.6 ie	05/86-02/92	<b>8432</b>	<>		482		82422139
1.6 ie	05/86-02/92	<b>8373</b>	<>		410		82392239
1.9 D, TD	05/84-02/92	<b>8372</b>	<>		460		82397551
1.9 D, TD	05/84-02/92	<b>8373</b>	<>		410		82392239

## TUBI FLESSIBILI PER FRENO



L



o.e.

### THEMA

-08/92							
TT (- ABS)	07/84-08/92	<b>8400</b>	<>		582		82422141
TT (+ ABS)	07/84-08/92	<b>8470</b>	<>		582		82422143
TT	07/84-08/92	<b>8401</b>		<>	407		82422142
09/92-07/94							
TT	08/92-07/94	<b>8572</b>	<>		560		82473716
TT	08/92-07/94	<b>8401</b>		<>	407		82422142

### THESIS

TT (- 3.0 V6)	07/02-	<b>80175</b>	<>		420		46808215
TT	07/02-	<b>80179</b>		<>	271		51711589

### Y10

1.0	03/85-10/85	<b>8381</b>	<>		410		7563848
1.0, 1.05 Touring, 1.1	11/85-03/89	<b>8357</b>	<>		361		5941315
1.0, 1.05 Touring, 1.1	04/89-12/95	<b>8430</b>	<>		357		7590581

Legenda/Legend: ○ = Intermedio/Intermediate - ● = Interno/Inner - ▲ = Superiore/Upper - ▼ = Inferiore/Lower



**TUBI FLESSIBILI PER FRENO**

**L**

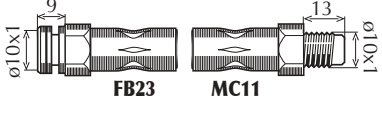
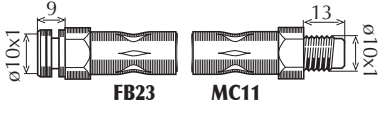
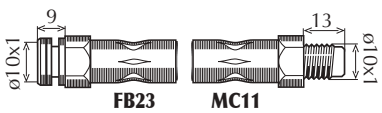
**o.e.**
**segue Y10**

1.0, 1.05 Touring, 1.1	03/85-03/89	<b>8382</b>	<>		210		7563845
1.0, 1.05 Touring, 1.1	04/89-12/95	<b>8489</b>	<>		210		7593353
1.05 Turbo, 1.3 GT, 1.3 ie	03/85-12/95	<b>8431</b>	<>		402		7590582

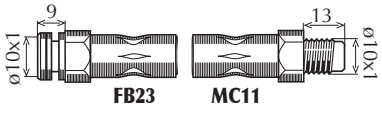
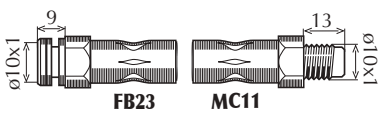
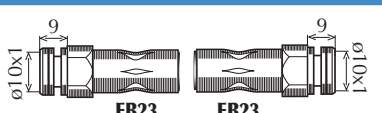
**Y**

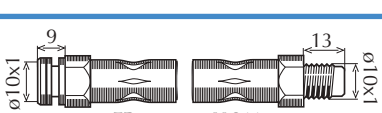
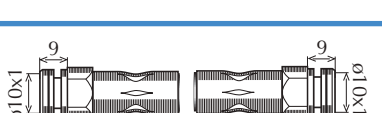
1.1, 1.2 8V	11/95-	<b>8481</b>	>		385		46423177
1.1, 1.2 8V	11/95-	<b>8482</b>	<		385		46423176
1.1, 1.2 8V	11/95-	<b>8427</b>	<>		217		7603330
1.2 16V, 1.4 1.2V	11/95-	<b>8483</b>	>		420		7735011
1.2 16V, 1.4 1.2V	11/95-	<b>8484</b>	<		410		7735010
1.2 16V, 1.4 1.2V	11/95-	<b>8427</b>	<>		217		7603330

**YPSILON (MOD. 2003)**

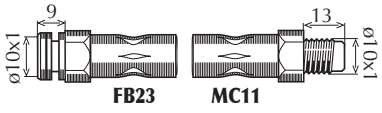
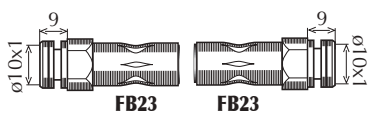
TT	10/03-	<b>80178</b>	<>		470		46845598
TT	10/03-	<b>8265</b>	<>		195		46834651

TUBI FLESSIBILI PER FRENO



L



o.e.

segue YPSILON (MOD. 2003)

Momo disign (Alla pinza)	2007-	8611	<>	245	<p>FB23 MC11</p>	82442878
--------------------------	-------	------	----	-----	------------------	----------

YPSILON (MOD. 2010)

TT	08/10-	80262	<>	385	<p>FB23 MC11</p>	51800680
TT	08/10-	80985	<>	175	<p>FB23 FB23</p>	51902262

ZETA

TT	94-05/97	8569	<>	515	<p>FZ MG1</p>	1479197080
TT	06/97-09/02	80159	<>	450	<p>FZ MC11</p>	1489794080
TT (intermedio)	94-09/02	8573	○	275	<p>FZ FZ</p>	1472157080
TT	94-09/02	8570	<>	325	<p>FZ MC11</p>	1472155080

## TUBI FLESSIBILI PER FRENO



L



o.e.

### DEFENDER

#### 90

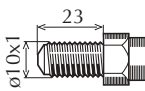
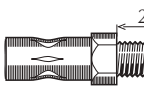
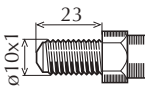
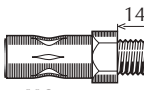
2.5, 3.5, 2.5 TD	01/90-	<b>80269</b>	<>		445	 MC22	 MC22	NRC7874
2.5, 3.5, 2.5 TD	01/90-	<b>80397</b>	<>		350	 MC22	 MC59	NRC9455

#### 110

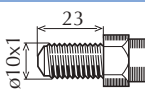
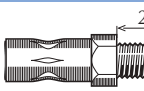
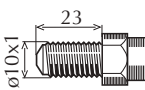
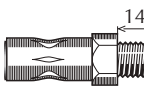
2.5, 3.5, 2.5 TD	01/90-	<b>80269</b>	<>		445	 MC22	 MC22	NRC7874
2.5, 3.5, 2.5 TD	01/90-	<b>80341</b>	<>		435	 MC22	 MC59	NTC3458

#### 130

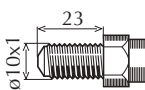
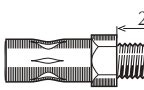
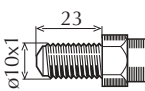
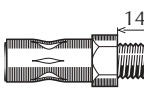
2.5 TD	01/90-	<b>80269</b>	<>		445	 MC22	 MC22	NRC7874
2.5 TD	01/90-	<b>80341</b>	<>		435	 MC22	 MC59	NTC3458

### DISCOVERY

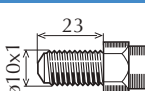
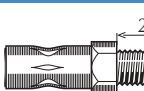
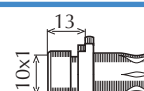
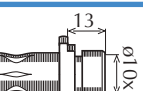
3.5, 2.5 TD	89-07/92	<b>8454</b>	<>		470	 MC22	 MC22	
3.5, 2.5 TD	01/93-	<b>80537</b>	<>		385	 FB26	 FB26	ANR3258

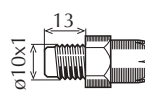
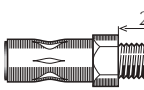
3.5, 2.5 TD	89-	<b>8456</b>	<>		435	 MC11	 MC22	
-------------	-----	-------------	----	--	-----	--	---	--



## TUBI FLESSIBILI PER FRENO



L



o.e.

### DISCOVERY II

2.5 TDI, 4.0	11/98-06/04	<b>80986</b>	▲		525		SHB101180
2.5 TDI, 4.0	11/98-06/04	<b>80987</b>	▼		525		SHB101190
2.5 TDI, 4.0	11/98-06/04	<b>80988</b>	▲		345		SHB101170
2.5 TDI, 4.0	11/98-06/04	<b>80989</b>	▼		350		SHB101200

### DISCOVERY III

2.7 TDV6, 4.4	07/04-	<b>80990</b>	▲				LR018107
2.7 TDV6, 4.4	07/04-	<b>80991</b>	▼				LR018110
2.7 TDV6, 4.4	07/04-	<b>80992</b>	▲▼		345		LR018111

Legenda/Legend: ○ = Intermedio/Intermediate - ● = Interno/Inner - ▲ = Superiore/Upper - ▼ = Inferiore/Lower

## TUBI FLESSIBILI PER FRENO



L



o.e.

### DISCOVERY IV

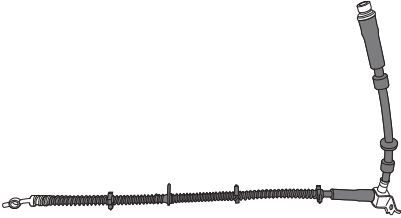
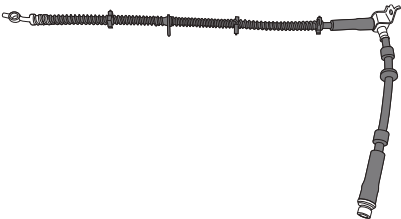
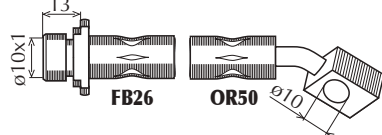
TT	07/04-	81052	<				LR020006
TT	07/04-	81053	>				LR020007
TT	07/04-	80992	<>		345		LR018111

### FREELANDER

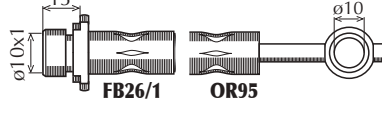
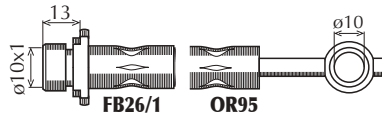
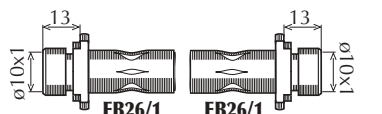
TT	02/98-CH:YA999999	80538	<>		445		SHB101000
TT	CH:2A393451->	80678	<>		448		SHB000591
TT	02/98-	80680	<>		280		SHB000601

### FREELANDER 2

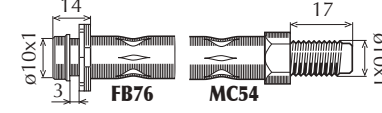
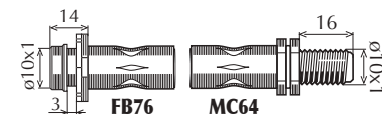
TT	10/06-	80697	<>		445		LR008148
TT	10/06-	80698	<>		520		LR008149

## TUBI FLESSIBILI PER FRENO



L



o.e.

### RANGE ROVER

(70->81)

TT	70-81	8453	<>		465	<p>MC4 MC4</p>	
TT	70-81	8455	<>		425	<p>MC4 MF6</p>	

(81->91)

TT	81-06/91	8454	<>		470	<p>MC22 MC22</p>	
TT	81-06/91	8456	<>		435	<p>MC11 MC22</p>	

### RANGE ROVER II

TT	1993-03/02	80537	<>		385	<p>FB26 FB26</p>	ANR3258
TT	1993-03/02	80993	<>		230	<p>FB26 OR207</p>	ANR3628

### RANGE ROVER III

TT	03/02-	80994	<>		510	<p>F6 MC55</p>	SHB000011
----	--------	-------	----	--	-----	----------------	-----------

### RANGE ROVER SPORT

TT	07/04-	80995	<				LR019329
----	--------	-------	---	--	--	--	----------

## TUBI FLESSIBILI PER FRENO



L



o.e.

### segue RANGE ROVER SPORT

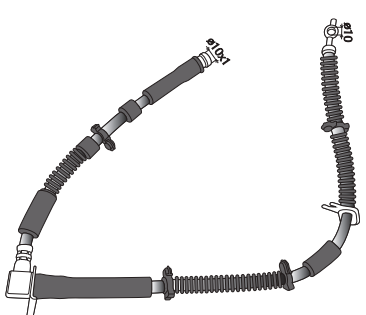
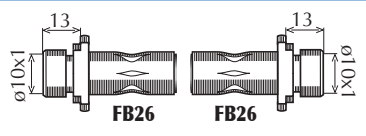
TT	07/04-	80996	>				LR018106
TT	07/04-	80997	<>	315			LR018112

## TUBI FLESSIBILI PER FRENO



L



o.e.

2

TT	04/03-	8914	<>		520	<p>FB69 MG1</p>	D43643980
TT	04/03-	80412	<>		330	<p>FB61 FB61</p>	D35043810B

2 (Mod.2007)

TT	10/07-	80799	<			<p>Il disegno non è disponibile The drawing is not available</p>	D65143990
TT	10/07-	80800	>			<p>Il disegno non è disponibile The drawing is not available</p>	D65143980
TT	10/07-	80801	<>			<p>Il disegno non è disponibile The drawing is not available</p>	D65143810

3

TT	10/03-	80639	<>		445	<p>FB42 MG13</p>	BP4K43980D
TT	10/03-	80539	<>		420	<p>FB42 MC55</p>	BP4L43980D

5

TT	02/05-	80639	<>		445	<p>FB42 MG13</p>	BP4K43980D
TT	02/05-	80802	<>			<p>Il disegno non è disponibile The drawing is not available</p>	C23643980A

## TUBI FLESSIBILI PER FRENO



L



o.e.

6

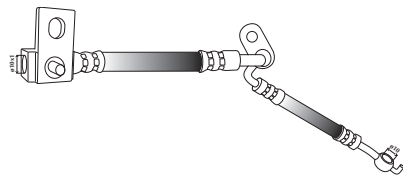
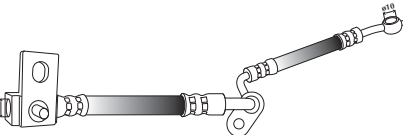
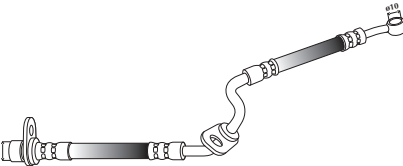
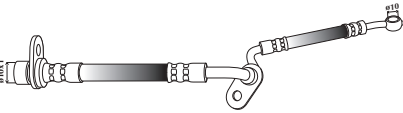
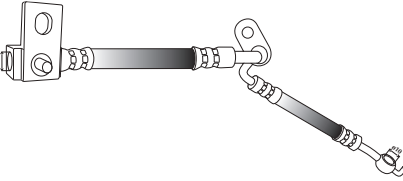
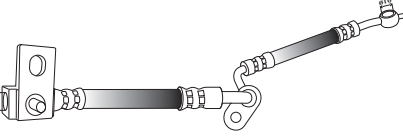
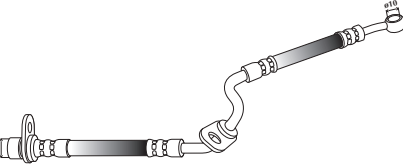
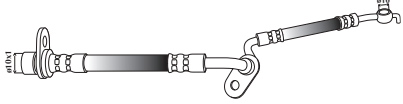
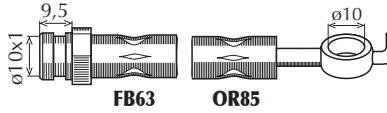
1.8	06/02-9/03	<b>80540</b>	▼		640		GJ6A43980B
1.8	06/02-9/03	<b>80541</b>	▲		640		GJ6A43990B
1.8	09/03-	<b>80542</b>	▼		640		GJ6A43980C
1.8	09/03-	<b>80543</b>	▲		640		GJ6A43990C
TT (- 1.8)	06/02-9/03	<b>80219</b>	▼		645		GJ6E43980B
TT (- 1.8)	06/02-9/03	<b>80218</b>	▲		645		GJ6E43990B
TT (- 1.8)	09/03-	<b>80221</b>	▼		645		GJ6E43980C
TT (- 1.8)	09/03-	<b>80220</b>	▲		645		GJ6E43990C
TT	06/02-	<b>80222</b>	<>		275	 <p>9,5 ø10x1 FB63 OR85 ø10</p>	GJ6A43810

## TUBI FLESSIBILI PER FRENO

**L**

**o.e.**

### 6 (Mod.2007)

TT	08/07-	<b>80803</b>	<			Il disegno non è disponibile The drawing is not available	GS1D43990A
TT	08/07-	<b>80804</b>	>			Il disegno non è disponibile The drawing is not available	GS1D43980A
TT	08/07-	<b>80805</b>	<>			Il disegno non è disponibile The drawing is not available	GS1D43810B

### 121

TT	03/96-	<b>8604</b>	>		415		1E0043810D
TT	03/96-	<b>8687</b>	<		415		1E0143810D
TT	03/96-	<b>8607</b>	<>		335		1E0043980

### 323 F

#### (BG) 89-07/94

1.3, 1.3 16V, 1.6, 1.6 16V, 1.8 16V, 1.7 D	89-07/94	<b>80037</b>	<>		435		B45543980B
1.3, 1.3 16V, 1.6, 1.6 16V, 1.8 16V, 1.7 D	89-07/94	<b>80038</b>	<>		281		B45543810A
1.3, 1.3 16V, 1.6, 1.6 16V, 1.8 16V, 1.7 D (Disco post)	89-07/94	<b>80545</b>	<>		425		B46143980C

#### (BA) 08/94-09/98

1.3 16V, 1.5 16V, 1.8, 1.6 TD	08/94-09/98	<b>80037</b>	<>		435		B45543980B
-------------------------------	-------------	--------------	----	--	-----	--	------------

## TUBI FLESSIBILI PER FRENO



L



o.e.

### segue 323 F

#### segue (BA) 08/94-09/98

1.3 16V,1.5 16V,1.8,1.6 TD	08/94-09/98	<b>80546</b>	<>	310		BC1D43810
----------------------------	-------------	--------------	----	-----	--	-----------

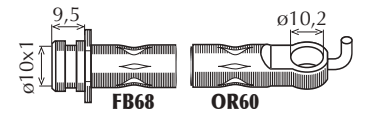
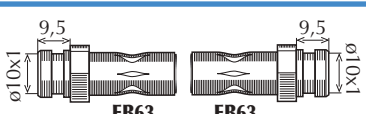

### 323 F- S (BJ) 98-

1.4,1.6,2.0,2.0 D,2.0 TD	98-	<b>80039</b>	<>	405		B25D43980A
1.4,1.6,2.0,2.0 D,2.0 TD	98-	<b>80040</b>	<>	280		GA7B43810

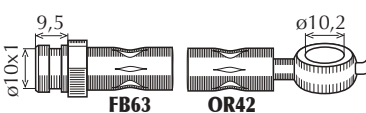
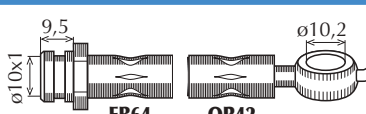
### 626 (GE) 92-97

TT	92-04/97	<b>80037</b>	<>	435		B45543980B
TT (- SW)	92-04/97	<b>80041</b>	<>	505		GJ2543980

### 626 (GF)(SW) 5/97-

1.9, 2.0, 1.9 DI	05/97-	<b>80042</b>	<>	420		C00143980
1.9, 2.0, 1.9 DI	05/97-	<b>80043</b>	<>	535		BK1T43980

### CX7

TT	11/06-	<b>80900</b>	<>		<div style="background-color: #e0e0e0; padding: 5px; text-align: center;">                     Il disegno non è disponibile                      The drawing is not available                 </div>	EG2343980A
TT	11/06-	<b>80901</b>	<>		<div style="background-color: #e0e0e0; padding: 5px; text-align: center;">                     Il disegno non è disponibile                      The drawing is not available                 </div>	EG2343810B



## TUBI FLESSIBILI PER FRENO



o.e.

### DEMIO

TT	8/98-	80547	<>		475		D06143980A
TT	8/98-	80411		▼	290		D06143810E
TT	8/98-	80548		▲	270		D06243810B

### MPV I

TT	03/95-09/99	80549	<>		545		LA0143980A
TT	03/95-09/99	80550		○	375		LB4043820B
TT	03/95-09/99	80551		▼	280		LB8243810A
TT	03/95-09/99	80552		▲	280		LB8243820A

### MPV II

TT	09/99-	80553	<>		445		LC6243980B
TT	09/99-09/03	80554	<>		345		LC6243810B
TT	10/03-	80555		▼	350		LE4443810B

Legenda/Legend: ○= Intermedio/Intermediate - ●= Interno/Inner - ▲= Superiore/Upper - ▼= Inferiore/Lower

## TUBI FLESSIBILI PER FRENO



L





o.e.

### segue MPV II

TT	10/03-	80556	<	350		LE4443820B
----	--------	-------	---	-----	--	------------

### MX3

1.6, 1.8	07.91-	80037	<>	435		B45543980B
----------	--------	-------	----	-----	--	------------

1.6, 1.8	07.91-	80557	<>	450		EA0143980A
----------	--------	-------	----	-----	--	------------

### PRIMACY

1.9	99-	80039	<>	405		B25D43980A
-----	-----	-------	----	-----	---	------------

1.9	98-	80040	<>	280		GA7B43810
-----	-----	-------	----	-----	--	-----------

## TUBI FLESSIBILI PER FRENO



L



o.e.

### ROADSTER

TT	04/03-	<b>80198</b>	< >		338	<p>FB23 MC11</p>	4162V001000000
----	--------	--------------	-----	--	-----	------------------	----------------

### City Coupe' (MC01)

TT	07/98-	<b>80198</b>	< >		338	<p>FB23 MC11</p>	4162V001000000
----	--------	--------------	-----	--	-----	------------------	----------------

TT	07/98-	<b>80558</b>	< >		365	<p>FB23 MC65</p>	4163V001000000
----	--------	--------------	-----	--	-----	------------------	----------------

### Fortwo Coupé (Mod.2007)

TT	01/07-	<b>80854</b>	< >		310	<p>FB23 MC11</p>	4514200048
----	--------	--------------	-----	--	-----	------------------	------------

TT	01/07-	<b>80855</b>	< >			<p>Il disegno non è disponibile The drawing is not available</p>	4514200148
----	--------	--------------	-----	--	--	--	------------

## TUBI FLESSIBILI PER FRENO



L





o.e.

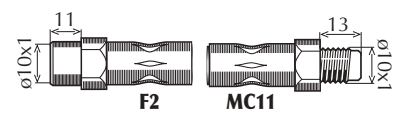
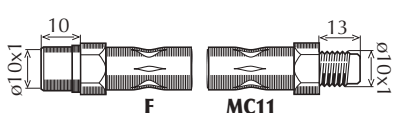

### 190 (W201)

TT	10/82-08/93	<b>8487</b>	<>		340		1234280635
TT	10/82-08/93	<b>8289</b>	<>		310		1234280135

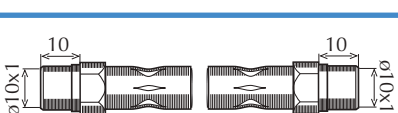
### 200 (W114-115)

TT	01/68-10/76	<b>8178</b>	<>		445		1234280535
TT (->CH:064095)	01/68-	<b>8254</b>	<>		265		0044282635
TT (CH:064095->)	-10/76	<b>8243</b>	<>		290		1264280135

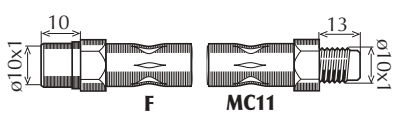
### 200 (W123)

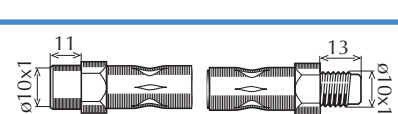
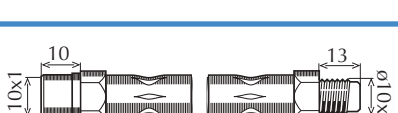
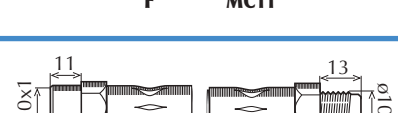
200 (->CH:126115)	01/76-	<b>8232</b>	<>		390		1234280235
200 (CH:126116->)	-12/85	<b>8487</b>	<>		340		1234280635
230 (->CH:158335)	01/76-	<b>8232</b>	<>		390		1234280235
230 (CH:158336->)	-12/85	<b>8487</b>	<>		340		1234280635
260, 280 (->CH:079228)	01/76-	<b>8232</b>	<>		390		1234280235
260, 280 (CH:079229->)	-12/85	<b>8487</b>	<>		340		1234280635

## TUBI FLESSIBILI PER FRENO



L



o.e.

### segue 200 (W123)

200D (->CH:179865)	01/76-	<b>8232</b>	<>		390		1234280235
200D (CH:179866->)	-12/85	<b>8487</b>	<>		340		1234280635
230D, 250D (->CH:150314)	01/76-	<b>8232</b>	<>		390		1234280235
230D, 250D (CH:150315->)	-12/85	<b>8487</b>	<>		340		1234280635
300D, 320D (->CH:165147)	01/76-	<b>8232</b>	<>		390		1234280235
300D, 320D (CH:165148->)	-12/85	<b>8487</b>	<>		340		1234280635
TT	01/76-12/85	<b>8289</b>	<>		310		1234280135

### 200 (W124)

TT	12/84-06/93	<b>8487</b>	<>		340		1234280635
TT	12/84-06/93	<b>8289</b>	<>		310		1234280135

### CLASSE A (W168)

TT	07/97-08/04	<b>8927</b>	<>		310		1684280335
TT (Tamburo Post.)	07/97-08/04	<b>8928</b>	<>		365		1684280235

Legenda/Legend: ○= Intermedio/Intermediate - ●= Interno/Inner - ▲= Superiore/Upper - ▼= Inferiore/Lower

## TUBI FLESSIBILI PER FRENO



o.e.

### segue CLASSE A (W168)

TT (Disco Post.)	07/97-08/04	<b>80193</b>	<>	257		1684280635
------------------	-------------	--------------	----	-----	--	------------

### CLASSE A (W169)

TT	09/04-	<b>80194</b>	<>	496		1694280035
----	--------	--------------	----	-----	--	------------

TT	09/04-	<b>80193</b>	<>	257		1684280635
----	--------	--------------	----	-----	--	------------

### CLASSE B (W245)

TT	03/05-	<b>80194</b>	<>	496		1694280035
----	--------	--------------	----	-----	---	------------

TT	03/05-	<b>80193</b>	<>	257		1684280635
----	--------	--------------	----	-----	--	------------

### CLASSE B (W246)

TT	11/11-	<b>81054</b>	<>		Il disegno non è disponibile The drawing is not available	2464200248
----	--------	--------------	----	--	--	------------

TT	11/11-	<b>81055</b>	<>		Il disegno non è disponibile The drawing is not available	2464200148
----	--------	--------------	----	--	--	------------

### CLASSE C (W202)

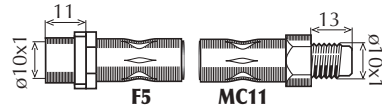
TT	03/93-08/95	<b>8068</b>	<>	505		2024200148
----	-------------	-------------	----	-----	--	------------

TT	09/95-03/01	<b>8011</b>	<>	415		2024280735
----	-------------	-------------	----	-----	--	------------

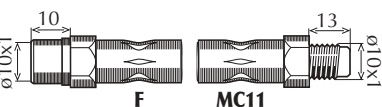
TT	03/93-08/95	<b>8289</b>	<>	310		1234280135
----	-------------	-------------	----	-----	--	------------

## TUBI FLESSIBILI PER FRENO



L



o.e.

### segue CLASSE C (W202)

TT	09/95-03/01	<b>80236</b>	<>		315		2104280035
----	-------------	--------------	----	--	-----	--	------------

### CLASSE C (W203)

TT	05/00-	<b>8011</b>	<>		415		2024280735
----	--------	-------------	----	--	-----	--	------------

TT	05/00-	<b>80236</b>	<>		315		2104280035
----	--------	--------------	----	--	-----	--	------------

### CLASSE C (W204)

TT	01/07-	<b>8011</b>	<>		415		2024280735
----	--------	-------------	----	--	-----	--	------------

TT	01/07-	<b>80806</b>	<>		330		2044201048
----	--------	--------------	----	--	-----	--	------------

### CLASSE CLK (C208)

TT	06/97-06/02	<b>8011</b>	<>		415		2024280735
----	-------------	-------------	----	--	-----	--	------------

TT	06/97-06/02	<b>80236</b>	<>		315		2104280035
----	-------------	--------------	----	--	-----	--	------------

### CLASSE CLK (C209)

TT	06/02-	<b>8011</b>	<>		415		2024280735
----	--------	-------------	----	--	-----	--	------------

TT	06/02-	<b>80236</b>	<>		315		2104280035
----	--------	--------------	----	--	-----	--	------------

## TUBI FLESSIBILI PER FRENO





L





o.e.

### CLASSE CLS (C219)

TT	10/04-	<b>80196</b>	<>		406		2204200048
TT	10/04-	<b>80195</b>	<>		283		2114200548

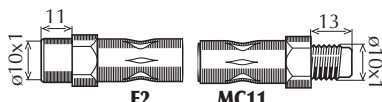

### CLASSE E (W124)

TT	07/93-06/95	<b>8487</b>	<>		340		1234280635
TT	07/93-06/95	<b>8289</b>	<>		310		1234280135



### CLASSE E (W210)

TT	06/95-02	<b>8011</b>	<>		415		2024280735
TT	06/95-02	<b>80236</b>	<>		315		2104280035

### CLASSE E (W211)

TT	03/02-	<b>80196</b>	<>		406		2204200048
TT	03/02-	<b>80195</b>	<>		283		2114200548

### CLASSE E (W212)

TT	01/09-	<b>80807</b>	<>		430		2124280035
TT	01/09-	<b>80808</b>	<>		380		2124200448



## TUBI FLESSIBILI PER FRENO





L



o.e.

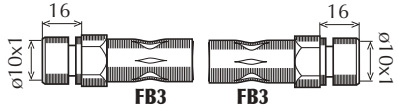

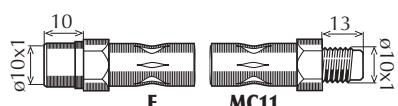
### CLASSE G (W461)

TT	04/92-	<b>80240</b>	<>		535		4614200748
TT (intermedio)	04/92-	<b>80299</b>		○	485		4604285135
TT	04/92-	<b>8232</b>		<>	390		1234280235

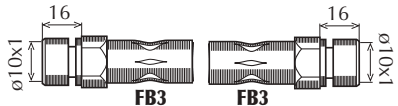
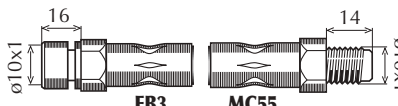
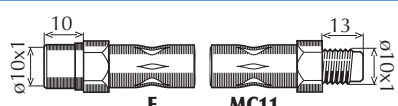

### CLASSE G (W463)

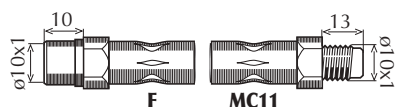
TT	09/94-	<b>80240</b>	<>		535		4614200748
TT (intermedio)	09/94-	<b>80299</b>		○	485		4604285135
TT	09/94-	<b>8232</b>		<>	390		1234280235

### CLASSE GLK (X204)

TT	01/07-	<b>80809</b>	<>		515		2044200748
TT	01/07-	<b>80806</b>	<>		330		2044201048

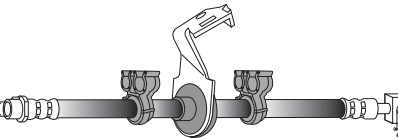
### CLASSE M (W163)

TT	03/98-06/05	<b>80559</b>		▼			1634202548
TT	03/98-06/05	<b>80560</b>		▲	540		1634202048

Legenda/Legend: ○= Intermedio/Intermediate - ●= Interno/Inner - ▲= Superiore/Upper - ▼= Inferiore/Lower

## TUBI FLESSIBILI PER FRENO



L



o.e.

### segue CLASSE M (W163)

TT	03/98-06/05	<b>80192</b>	<>	328		1634201348
----	-------------	--------------	----	-----	--	------------

### CLASSE M (W164)

TT	07/05-	<b>80998</b>	<>	575		1644200348
----	--------	--------------	----	-----	--	------------

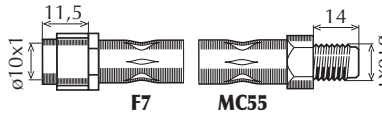
TT	07/05-	<b>80999</b>	<>	635		1644200548
----	--------	--------------	----	-----	--	------------

### CLASSE S (W116)

TT	08/72-07/80	<b>8178</b>	<>	445		1234280535
----	-------------	-------------	----	-----	---	------------

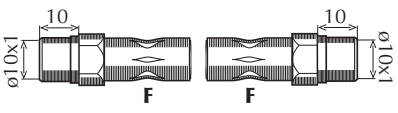
TT	08/72-03/73	<b>8243</b>	<>	290		1264280135
----	-------------	-------------	----	-----	--	------------

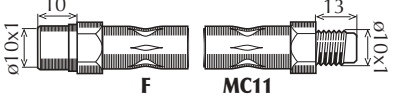
TT	04/73-07/80	<b>8289</b>	<>	310		1264280335
----	-------------	-------------	----	-----	--	------------

### CLASSE S (W126)

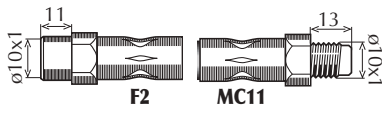
TT	10/79-06/91	<b>8487</b>	<>	340		1234280635
----	-------------	-------------	----	-----	--	------------

TT (- 500/560)	10/79-06/91	<b>8289</b>	<>	310		1264280335
----------------	-------------	-------------	----	-----	--	------------

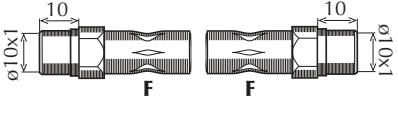
500, 560	10/79-06/91	<b>8243</b>	<>	290		1264280135
----------	-------------	-------------	----	-----	--	------------

## TUBI FLESSIBILI PER FRENO



L



o.e.

### CLASSE S (W140)

TT	03/93-02/99	<b>80282</b>	<>		560		1404200048
TT	03/93-06/93	<b>8289</b>	<>		310		1264280335
TT	07/93-02/99	<b>80236</b>	<>		315		2104280035

### CLASSE S (W220)

TT	11/98-08/05	<b>80196</b>	<>		406		2204200048
TT	11/98-08/05	<b>80236</b>	<>		315		2104280035

### CLASSE S (W221)

TT	09/05-	<b>81000</b>	<>		485		2214200548
TT	09/05-	<b>81001</b>	<>		380		2214200248

### CLASSE SL (R107)

TT	05/71-08/85	<b>8178</b>	<>		445		1234280535
TT	09/85-07/89	<b>8487</b>	<>		340		1234280635
TT	05/71-02/80	<b>8289</b>	<>		310		1264280335

Legenda/Legend: ○= Intermedio/Intermediate - ●= Interno/Inner - ▲= Superiore/Upper - ▼= Inferiore/Lower

## TUBI FLESSIBILI PER FRENO



L



o.e.

### segue CLASSE SL (R107)

TT	03/80-07/89	8243	<>	290	 	1264280135
----	-------------	------	----	-----	--	------------

### CLASSE SL (R129)

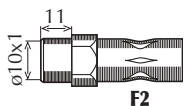
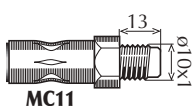
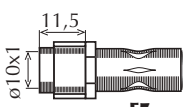
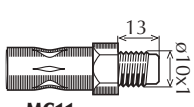
TT	03/89-10/01	8487	<>	340	 	1234280635
TT	03/89-10/01	80236	<>	315	 	2104280035

### CLASSE SLK (R170)

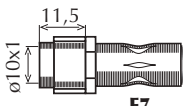
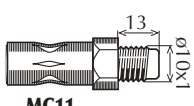
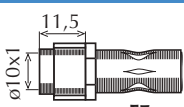
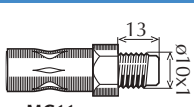
TT	04/96-	8011	<>	415	 	2024280735
TT	04/96-	80236	<>	315	 	2104280035

### CLASSE V

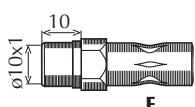
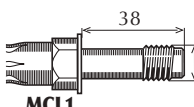
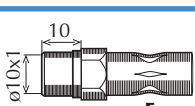
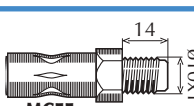
TT	03/97-	8929	<>	545	 	6384280835
TT	03/97-	8930	<>	525	 	6384281035

### VANEO

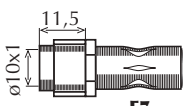
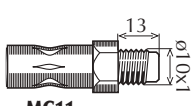
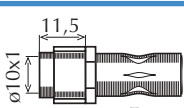
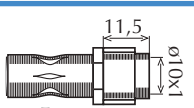
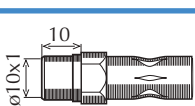
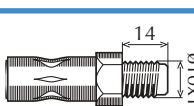
TT	02/02-	80197	<>	322	 	4144280035
TT (intermedio dx)	02/02-	80253	○	375	 	4144280135
TT (intermedio sx)	02/02-	8928	○	365	 	1684280235

## TUBI FLESSIBILI PER FRENO



L



o.e.

### segue Vaneo

TT	02/02-	<b>80193</b>	<>	257		1684280635
----	--------	--------------	----	-----	--	------------

### MERCEDES COMMERCIALI

#### 207 D - 208 D - 209 D - 210 D - 307 D - 308 D - 309 D - 310 D

TT	77-	<b>8013</b>	<>	495		0014289535
----	-----	-------------	----	-----	--	------------

TT	77-	<b>8178</b>	<>	445		0004286635
----	-----	-------------	----	-----	--	------------

#### 407 D - 408 D - 409 D - 410 D

TT	80-	<b>8013</b>	<>	495		0014289535
----	-----	-------------	----	-----	--	------------

TT	80-	<b>8178</b>	<>	445		0004286635
----	-----	-------------	----	-----	--	------------

### MB 100 D

TT	09/87-02/96	<b>8014</b>	<>	370		6314280035
----	-------------	-------------	----	-----	--	------------

TT	09/87-02/96	<b>80338</b>	<>	380		6314280335
----	-------------	--------------	----	-----	--	------------

### SPRINTER (901/902/903)



TT (- ABS)	02/95-	<b>80235</b>	<>	535		9014289135
------------	--------	--------------	----	-----	--	------------

TT (+ ABS)	02/95-	<b>8931</b>	<>	410		9014280435
------------	--------	-------------	----	-----	--	------------

**TUBI FLESSIBILI PER FRENO**

**L**

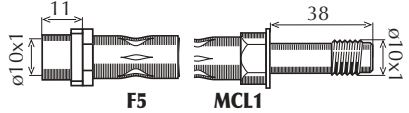
**o.e.**
**segue SPRINTER (901/902/903)**

TT (- ABS)	02/95-	<b>80245</b>	<>	438		9014280835
TT (+ ABS)	02/95-	<b>8931</b>	<>	410		9014280435

**SPRINTER (904)**

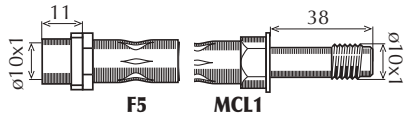
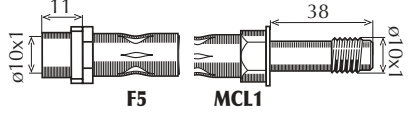
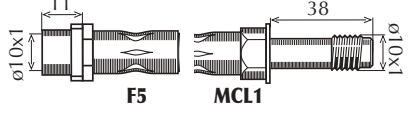
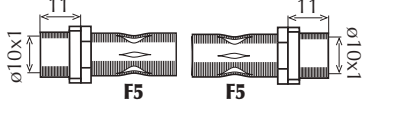
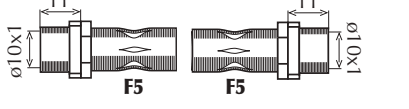
TT (- ABS)	02/95-	<b>80235</b>	<>	535		9014289135
TT (+ ABS)	02/95-	<b>8931</b>	<>	410		9014280435
TT (- ABS)	02/95-	<b>80245</b>	<>	438		9014280835
TT (+ ABS)	02/95-	<b>80242</b>	<>	390		9044280535
TT (+ ABS) (alla pinza)	02/95-	<b>80249</b>	<>	265		9044280435

**SPRINTER (906)**

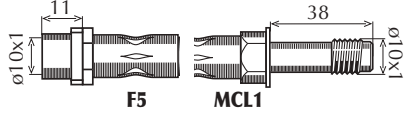
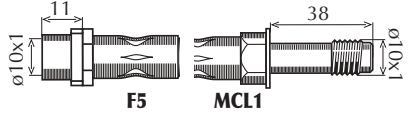
TT	06/06-	<b>80245</b>	<>	438		9064280535
TT	06/06-	<b>80245</b>	<>	438		9064280535

**VIANO**

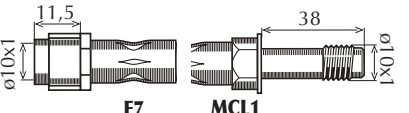
TT	09/03-	<b>80251</b>	<>	550		6394280835
----	--------	--------------	----	-----	--	------------

## TUBI FLESSIBILI PER FRENO



L



o.e.

### segue VIANO

TT	09/03-	<b>80250</b>	<>	358	<p>F7 MC11</p>	6394280435
----	--------	--------------	----	-----	----------------	------------

### VITO (638)

TT	03/97-	<b>8929</b>	<>	545	<p>F MC55</p>	6384280835
----	--------	-------------	----	-----	---------------	------------

TT	03/97-	<b>8930</b>	<>	525	<p>F MC55</p>	6384281035
----	--------	-------------	----	-----	---------------	------------

### VITO (639)

TT	09/03-	<b>80251</b>	<>	550	<p>F7 MCL1</p>	6394280835
----	--------	--------------	----	-----	----------------	------------

TT	09/03-	<b>80250</b>	<>	358	<p>F7 MC11</p>	6394280435
----	--------	--------------	----	-----	----------------	------------

**TUBI FLESSIBILI PER FRENO**

**L**

**o.e.**
**ASX**

TT	02/10	<b>80812</b>	<			Il disegno non è disponibile The drawing is not available	4650A645
TT	02/10	<b>80813</b>	>			Il disegno non è disponibile The drawing is not available	4650A646
TT	02/10	<b>80814</b>	<>			Il disegno non è disponibile The drawing is not available	4650A083

**CARISMA**

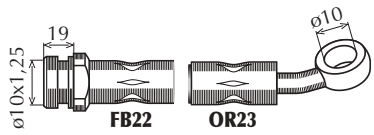
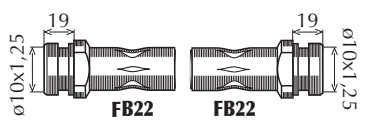
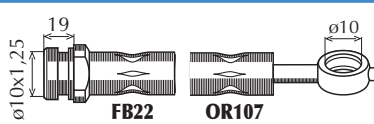
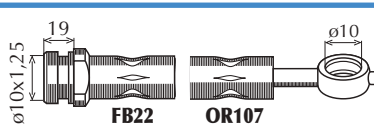
TT	07/95-	<b>8694</b>	<>		474		MB950308
TT (Tamburo Post.)	07/95-	<b>80414</b>	<>		230		MR910915
TT (Disco Post.)	07/95-04/99	<b>80561</b>	<>		425		MB950627
TT (Disco Post.)	05/99-	<b>80562</b>	<>		430		MM862413

**COLT I-II**

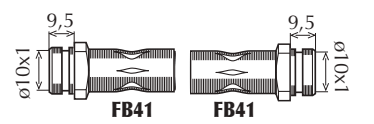
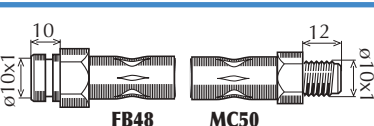
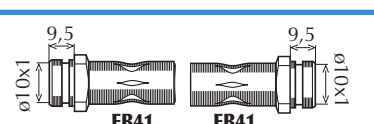
TT	12/78-04/88	<b>80044</b>	<>		318		MB238161
TT (alla pinza)	12/78-04/88	<b>80045</b>	<>		214		MB239151
TT	12/78-01/84	<b>80046</b>	<>		264		MB238160



## TUBI FLESSIBILI PER FRENO

**L**

**o.e.**

### COLT III (C5 A)

TT	04/88-05/92	<b>80044</b>	< >		318		MB238161
TT (alla pinza)	04/88-05/92	<b>80045</b>	< >		214		MB239151
TT	04/88-05/92	<b>80047</b>	< >		260		MB238163

### COLT IV (CA A)

TT	05/92-04/96	<b>80391</b>	< >		430		MR129799
TT	05/92-04/96	<b>80369</b>	< >		235		MB857567

### COLT V (CJ A)

TT	04/96-07/05	<b>80389</b>	< >		450		MR129882
TT	04/96-07/05	<b>80369</b>	< >		235		MB857567

### COLT VI

TT (freno a disco)	06/04-	<b>80357</b>	< >		490		4605A071
TT (freno a disco)	06/04-	<b>80563</b>	< >		485		MR955329
TT (freno a tamburo)	06/04-	<b>80811</b>	< >		290		MR955330

**TUBI FLESSIBILI PER FRENO**

**L**

**o.e.**
**COLT VII**

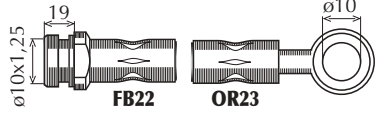
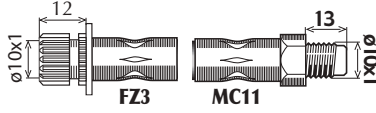
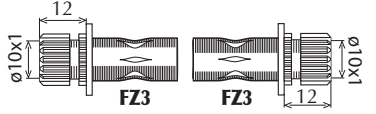
TT (freno a disco)	09/08-	<b>80357</b>	<>		490		4605A071
TT (freno a disco)	09/08-	<b>80563</b>	<>		485		MR955329
TT (freno a tamburo)	09/08-	<b>80811</b>	<>		290		MR955330
TT (Tamburo Post.)	09/08-	<b>81056</b>	<>			Il disegno non è disponibile The drawing is not available	4605B136
TT (Disco Post.)	09/08-	<b>81057</b>	<>			Il disegno non è disponibile The drawing is not available	4605B135

**COLT CZC**

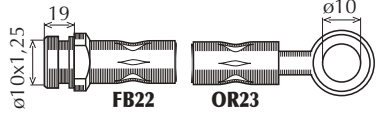
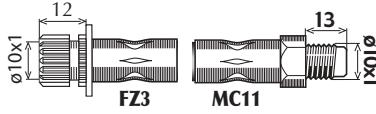
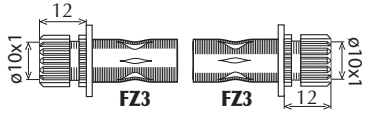
TT (freno a disco)	05/06-	<b>80357</b>	<>		490		4605A071
TT (freno a disco)	05/06-	<b>80563</b>	<>		485		MR955329
TT (freno a tamburo)	05/06-	<b>80811</b>	<>		290		MR955330

**CORDIA (A21 A)**

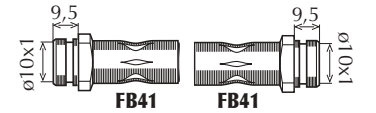
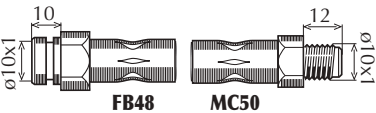
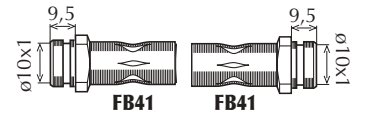
TT	09/82-12/86	<b>80044</b>	<>		318		MB238161
TT (alla pinza)	09/82-12/86	<b>80045</b>	<>		214		MB239151
TT	09/82-12/86	<b>80046</b>	<>		264		MB238160

## TUBI FLESSIBILI PER FRENO



L



o.e.

### ECLIPSE I (D2 A)

TT	04/91-11/95	80045	<>		214		MB239151
TT	04/91-11/95	80360	<>		255		MR129750

### GALANT II (A16 )

TT (alla pinza)	09/80-05/84	80045	<>		214		MB239151
TT	09/80-05/84	80044	<>		318		MB238161

### GALANT III (E1 A )

TT	09/82-12/87	80044	<>		318		MB238161
TT (alla pinza)	09/82-12/87	80045	<>		214		MB239151
TT	09/82-12/87	80047	<>		260		MB238163
TT (alla pinza)	09/82-12/87	80360	<>		255		MR129750

### GALANT IV (E3 A )

TT	11/87-10/92	80044	<>		318		MB238161
TT (- 4x4) (alla pinza)	11/87-10/92	80045	<>		214		MB239151

# TUBI FLESSIBILI PER FRENO



L



o.e.

## segue GALANT IV (E3 A )

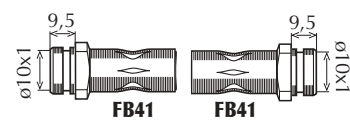
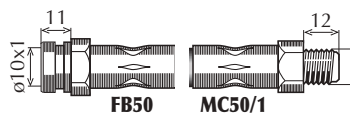
TT (- 4x4)	11/87-10/92	<b>80048</b>	<>	290		MB500452
TT (- 4x4) (alla pinza)	11/87-10/92	<b>80360</b>	<>	255		MR129750

## GALANT V (E5 A )

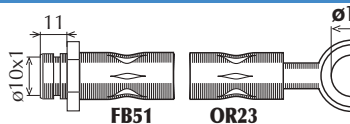
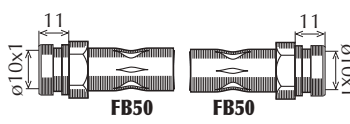
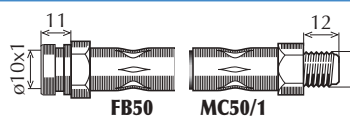
TT	11/92-08/96	<b>80442</b>	<>	550		MR129844
TT (Tamburo Post.)	11/92-08/96	<b>80589</b>	<>	265		MMR129796
TT (Disco Post.)	11/92-08/96	<b>80593</b>	<>	265		MR129751

## GALANT VI (EA )

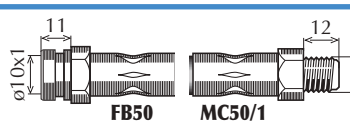
TT	09/96-	<b>80606</b>	<>	580		MMR334054
TT (Tamburo Post.)	09/96-	<b>80360</b>	<>	255		MR129750

## GRANDIS

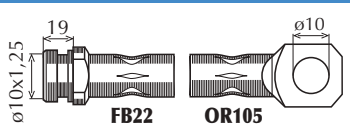
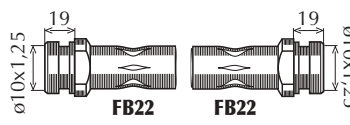
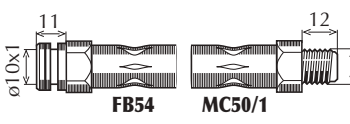
TT	04/04-	<b>80564</b>	<>	505		MR955461
TT (intermedio)	04/04-	<b>80565</b>	○	405		MR955467
TT	04/04-	<b>80351</b>	<>	270		MR955468

## TUBI FLESSIBILI PER FRENO



L



o.e.

### L200

#### L200 (K T)

2.5 D	11.86-08.96	80044	<>		318		MB238161
2.5 TD, 2.5 TD 4WD, 2.6 4WD	11.86-08.96	80049	<>		220		MB857552
TT (4WD) (alla pinza)	11.86-1990	80045	<>		214		MB239151
TT (4WD) (alla pinza)	1990-08.96	80350	<>		195		MB857535
TT	11.86-08.96	80350	<>	<>	195		MB857535

#### L200 (K6 T)

TT (Esterno)	06/96-	80048	<>		290		MB500452
TT (Interno)	06/96-	80045	<>		214		MB239151
TT	06/96-	80328	<>	<>	360		MR129795

#### L 300 (L0\_)

TT	04/83-04/94	80046	<>		264		MB238160
TT (alla pinza)	04/83-04/94	80049	<>		220		MB857552

Legenda/Legend: ○= Intermedio/Intermediate - ●= Interno/Inner - ▲= Superiore/Upper - ▼= Inferiore/Lower

**TUBI FLESSIBILI PER FRENO**

**o.e.**
**segue L 300 (L0\_)**

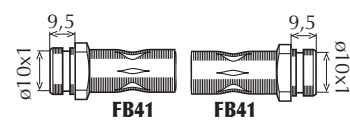
TT	04/83-04/94	<b>80050</b>	<>		380	 <b>FB41</b> <b>FB41</b>	MB699986
----	-------------	--------------	----	--	-----	---	----------

**L 300 (P0\_)**

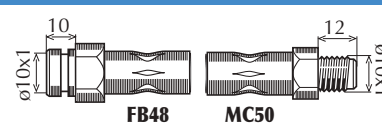
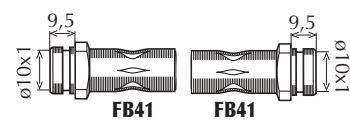
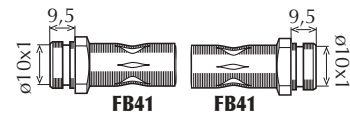
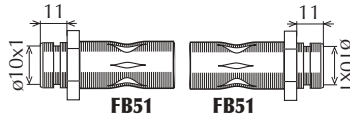
TT	11/86-12/94	<b>80045</b>	<>		214	 <b>FB48</b> <b>MC50</b>	MB239151
TT 4WD (alla pinza)	11/86-12/94	<b>80566</b>	<>		210	 <b>FB41</b> <b>FB41</b>	MB500748
TT	11/86-12/94	<b>80050</b>	<>		380	 <b>FB41</b> <b>FB41</b>	MB699986
TT 4WD (alla pinza)	11/86-12/94	<b>80372</b>	<>		380	 <b>FB51</b> <b>FB51</b>	MB058595

**L 300 (P1\_T)**

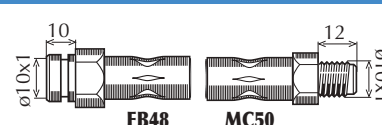
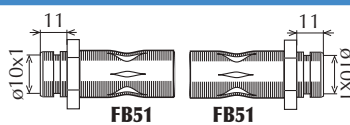
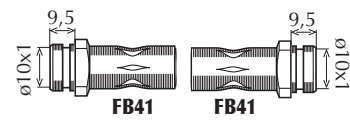
TT (Esterno)	07/94-	<b>80045</b>	<>		214	 <b>FB48</b> <b>MC50</b>	MB239151
TT (Interno)	07/94-	<b>80375</b>	<>		295	 <b>FB51</b> <b>FB51</b>	MR129720
TT	07/94-	<b>80050</b>	<>		380	 <b>FB41</b> <b>FB41</b>	MB699986

**LANCER II (A 17) - III (C1 A, C6 A)**

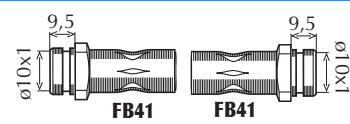
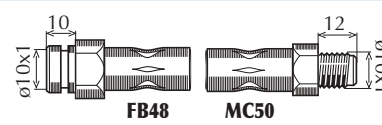
TT	03/83-09/86	<b>80044</b>	<>		318	 <b>FB41</b> <b>FB41</b>	MB238161
TT (alla pinza)	03/83-09/86	<b>80045</b>	<>		214	 <b>FB48</b> <b>MC50</b>	MB239151

## TUBI FLESSIBILI PER FRENO





L



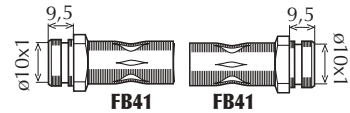

o.e.

### LANCER III SW (C1 V, C3 V)

TT	09/85-06/92	80044	<>		318		MB238161
TT (alla pinza)	09/85-06/92	80045	<>		214		MB239151
TT	09/85-06/92	80046	<>		264		MB238160

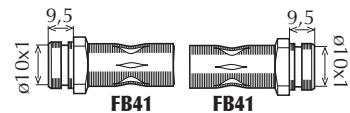
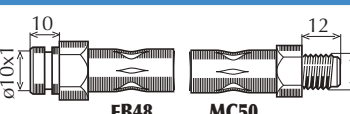
### LANCER IV (C6 A, C7 A)

TT	04/88-12/93	80044	<>		318		MB238161
TT (alla pinza)	04/88-12/93	80045	<>		214		MB239151
TT	04/88-12/93	80047	<>		260		MB238163

### LANCER V (CB A\_W, CD A\_W)

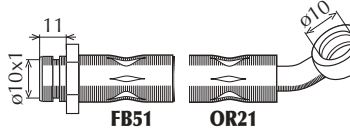
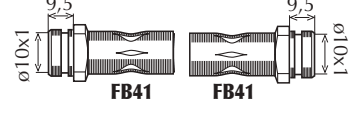
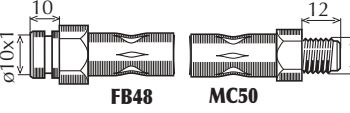
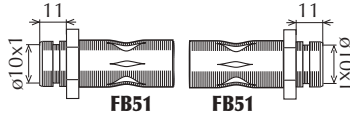
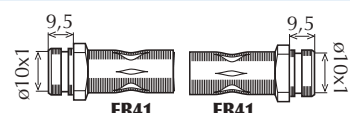
TT 2WD	04/92-10/03	80391	<>		430		MR129799
TT 4WD	04/92-10/03	80044	<>		318		MB238161
TT	04/92-10/03	80045	<>		214		MB239151
TT 2WD	04/92-10/03	80369	<>		235		MB857567
TT 4WD	04/92-10/03	80044	<>		318		MB238161

Legenda/Legend: ○= Intermedio/Intermediate - ●= Interno/Inner - ▲= Superiore/Upper - ▼= Inferiore/Lower



**TUBI FLESSIBILI PER FRENO**

**L**

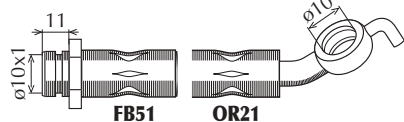
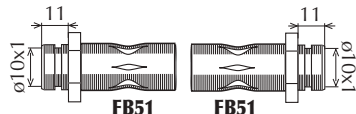
**o.e.**
**LANCER VI**

1.3 12V	05/96-	<b>80389</b>	<>		450		MR129882
1.3 12V	05/96-	<b>80369</b>	<>		235		MB857567

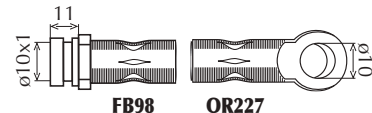
**LANCER VII (CY A\_W)**

1.3, 1.6, 2.0	08/03-	<b>80924</b>	<>		555		MR407889
1.3, 1.6, 2.0	08/03-	<b>80925</b>	<>		230		MR493450

**LANCER VIII (CY Z\_A)**

TT	01/08-	<b>80812</b>	<			<p>Il disegno non è disponibile The drawing is not available</p>	4650A645
TT	01/08-	<b>80813</b>	>			<p>Il disegno non è disponibile The drawing is not available</p>	4650A646
TT	01/08-	<b>80814</b>	<>			<p>Il disegno non è disponibile The drawing is not available</p>	4650A083

**OUTLANDER I**

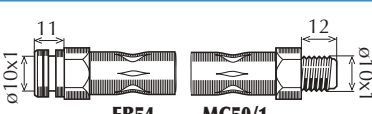
TT	05/03-	<b>80924</b>	<>		555		MR407889
TT	05/03-	<b>80925</b>	<>		230		MR493450



## TUBI FLESSIBILI PER FRENO



L



o.e.

### OUTLANDER II

TT	02/07-	80663	▲		630		4650A529
TT	02/07-	80664	▼		630		4650A530
TT	02/07-	80665	<>		305		4650A245

### PAJERO I (L04 G)

TT	11.88-11.90	80049	<>		220		MB857552
TT (alla pinza)	12/82-11.90	80051	<>		238		MB316287
TT	12/82-11.90	80052	<>		364		MB150761

### PAJERO II (V2\_W, V3\_W, V4\_W)

TT (Esterno)	12/90-04/00	80374	<>		185		MR129770
TT (Interno)	12/90-04/00	80343	<>		250		MR129749
TT V3_W (centrale)	07/96-04/00	80394	○		425		MR249392
TT V2_W, V4_W	12/90-04/00	80047	<>		260		MB238163
TT V3_W	12/90-06/96	80047	<>		260		MB238163

Legenda/Legend: ○= Intermedio/Intermediate - ●= Interno/Inner - ▲= Superiore/Upper - ▼= Inferiore/Lower

**TUBI FLESSIBILI PER FRENO**

**L**

**o.e.**
**segue PAJERO II (V2\_W, V3\_W, V4\_W)**

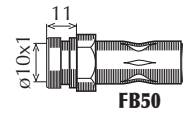
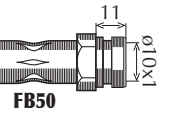
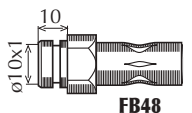
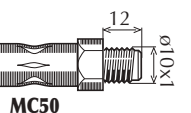
TT V3_W	07/96-04/00	<b>80328</b>	<>	360	 <b>FB50</b>	 <b>FB50</b>	MR129795
TT (alla pinza)	12/90-04/00	<b>80045</b>	<>	214	 <b>FB48</b>	 <b>MC50</b>	MB239151

**PAJERO III (V60, V70)**

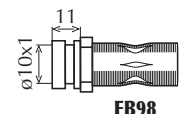
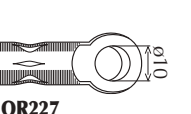
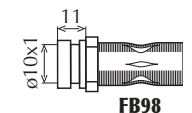
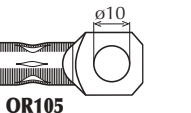
TT	04.00-	<b>80681</b>	<>		 <b>FB98</b>	 <b>OR227</b>	MR407225
TT	04.00-	<b>80682</b>	<>	555	 <b>FB98</b>	 <b>OR105</b>	MR407251

**SAPPORO III (E16A)**

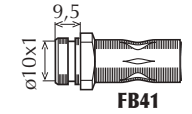
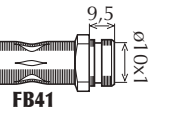
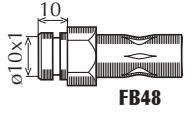
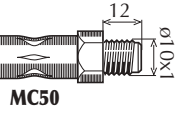
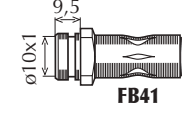
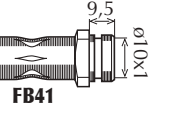
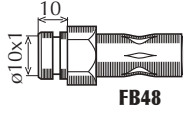
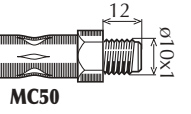
2.4	06/87-08/90	<b>80044</b>	<>	318	 <b>FB41</b>	 <b>FB41</b>	MB238161
2.4 (alla pinza)	06/87-08/90	<b>80045</b>	<>	214	 <b>FB48</b>	 <b>MC50</b>	MB239151
2.4	06/87-08/90	<b>80047</b>	<>	260	 <b>FB41</b>	 <b>FB41</b>	MB238163
2.4 (alla pinza)	06/87-08/90	<b>80045</b>	<>	214	 <b>FB48</b>	 <b>MC50</b>	MB239151

**SIGMA (F16A)**

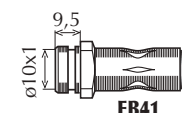
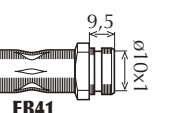
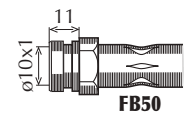
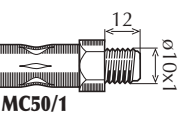
3.0	12/90-1993	<b>80044</b>	<>	318	 <b>FB41</b>	 <b>FB41</b>	MB238161
3.0	12/90-1993	<b>80360</b>	<>	255	 <b>FB50</b>	 <b>MC50/1</b>	MR129750

## TUBI FLESSIBILI PER FRENO

**L**

**o.e.**

### SPACE GEAR

TT	12/95-	<b>80363</b>	<>		335		MR129721
TT 4WD	12/95-	<b>80368</b>	<>		215		MR129771
TT	12/95-	<b>80366</b>		>	330		MR129788
TT	12/95-	<b>80567</b>		<	355		MR129793

### SPACE RUNNER (N1, N2)

TT	10.91-08.99	<b>80044</b>	<>		318		MB238161
TT (alla pinza)	10.91-08.99	<b>80045</b>	<>		214		MB239151
1.8, 1.8 4x4, 2.0 TD	10.91-08.99	<b>80046</b>		<>	264		MB238160

### SPACE RUNNER (N6)

TT	09/99-	<b>80568</b>	<>		525		MN116821
TT	09/99-	<b>80569</b>		<>	220		MR289286
TT (alla pinza)	09/99-	<b>80352</b>		<>	240		MR289287

Legenda/Legend: ○= Intermedio/Intermediate - ●= Interno/Inner - ▲= Superiore/Upper - ▼= Inferiore/Lower



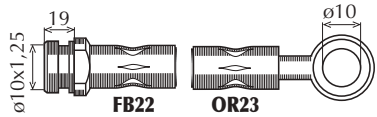
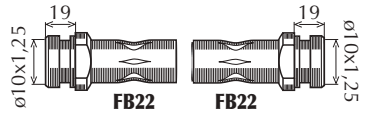
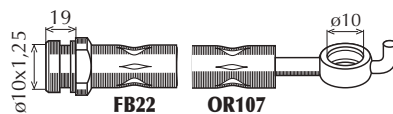

**TUBI FLESSIBILI PER FRENO**

**L**

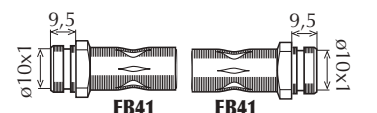

**o.e.**
**SPACE STAR**

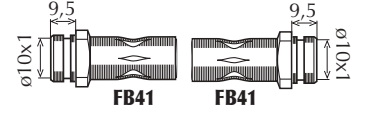
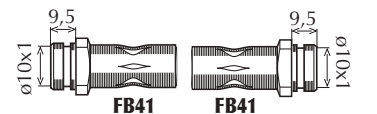
TT	06/98-	<b>8694</b>	<>		474	 <b>FB22</b> <b>OR23</b>	MB950308
TT (Tamburo Post.)	06/98-	<b>80414</b>	<>		230	 <b>FB22</b> <b>FB22</b>	MR910915
TT (Disco Post.)	02/01-	<b>80562</b>	<>		430	 <b>FB22</b> <b>OR107</b>	MM862413

**SPACE WAGON (DO W)**

TT (- 4x4)	06/86-04/91	<b>80044</b>	<>		318	 <b>FB41</b> <b>FB41</b>	MB238161
TT (- 4x4) (alla pinza)	06/86-04/91	<b>80045</b>	<>		214	 <b>FB48</b> <b>MC50</b>	MB239151
TT 4x4	06/86-04/91	<b>80051</b>	<>		238	 <b>FB41</b> <b>FB41</b>	MB316287
TT (- 4x4)	06/86-04/91	<b>80046</b>	<>		264	 <b>FB41</b> <b>FB41</b>	MB238160
TT 4x4	06/86-04/91	<b>80369</b>	<>		235	 <b>FB51</b> <b>FB51</b>	MB857567

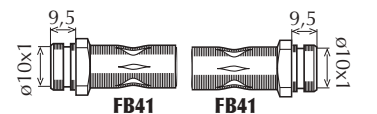
**SPACE WAGON (N3, N4)**

TT	05/91-10/98	<b>80044</b>	<>		318	 <b>FB41</b> <b>FB41</b>	MB238161
TT (alla pinza)	05/91-10/98	<b>80045</b>	<>		214	 <b>FB48</b> <b>MC50</b>	MB239151
TT (Tamburo Post.)	05/91-10/98	<b>80046</b>	<>		264	 <b>FB41</b> <b>FB41</b>	MB238160

## TUBI FLESSIBILI PER FRENO



L



o.e.

### segue SPACE WAGON (N3, N4)

TT (Disco Post.)	05/91-10/98	80346	<>	240		MR129755
------------------	-------------	-------	----	-----	--	----------

### SPACE WAGON (N5)

TT	05/91-10/98	80568	<>	525		MN116821
TT	05/91-10/98	80569	<>	220		MR289286
TT (alla pinza)	05/91-10/98	80352	<>	240		MR289287

### STARION / ECLIPSE

2.0 Turbo, 2.5 Turbo (alla pinza)	06.82-06.90	80045	<>	214		MB239151
2.0 Turbo, 2.5 Turbo	06.82-06.90	80046	<>	264		MB238160
2.0 Turbo, 2.5 Turbo (alla pinza)	06.82-06.90	80360	<>	255		MR129750

### TREDIA

1.4, 1.6, 1.8 (- Turbo & 4x4) (alla pinza)	09/82-10/87	80045	<>	214		MB239151
1.4, 1.6, 1.8 (- Turbo & 4x4)	09/82-10/87	80046	<>	264		MB238160
1.6, 1.8 Turbo	09/82-07/86	80044	<>	318		MB238161

Legenda/Legend: ○= Intermedio/Intermediate - ●= Interno/Inner - ▲= Superiore/Upper - ▼= Inferiore/Lower

TUBI FLESSIBILI PER FRENO



L



o.e.

segue TREDIA

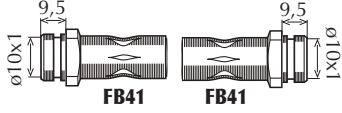
1.8 Turbo	09/82-07/86	80051	< >	238		MB316287
-----------	-------------	-------	-----	-----	--	----------

## TUBI FLESSIBILI PER FRENO

**L**

**o.e.**

### 100 NX

1.6, 1.6 SR, 2.0 GTI (Imp.Hitachi)	10/90-10/94	<b>80053</b>	< >		510		4621050Y12
1.6, 1.6 SR, 2.0 GTI (Imp.Nicirin)	10/90-10/94	<b>80054</b>	< >		510		4621050Y17
1.6, 1.6 SR, 2.0 GTI	10/90-10/94	<b>80080</b>	< >		260		4620489911

### ALMERA (N15)

1.4, 1.6, 2.0 D	09/95-	<b>80055</b>	< >		573		462100M300
1.4, 1.6, 2.0 D (Imp.Hitachi)	09/95-	<b>80056</b>	>		490		462100M001
1.4, 1.6, 2.0 D (Imp.Hitachi)	09/95-	<b>80057</b>	<		490		462100M007
1.4, 1.6, 2.0 D	09/95-	<b>80058</b>	< >		430		4621401A19

### ALMERA TINO

TT	08/00-	<b>80570</b>	>		500		462104U200
TT	08/00-	<b>80571</b>	<		500		462104U205
TT	08/00-	<b>80572</b>	>		610		462144U010

Legenda/Legend: ○= Intermedio/Intermediate - ●= Interno/Inner - ▲= Superiore/Upper - ▼= Inferiore/Lower

## TUBI FLESSIBILI PER FRENO



L



o.e.

### segue ALMERA TINO

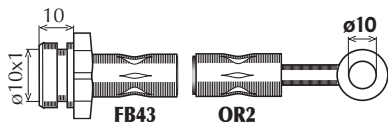
TT	08/00-	80273	▲	615		462144U011
----	--------	-------	---	-----	--	------------

### BLUEBIRD (T12)

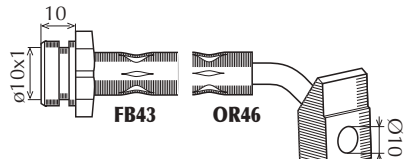
TT	1986-1990	80059	▼	410		4621001E11
----	-----------	-------	---	-----	--	------------

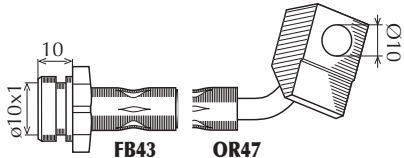
TT	1986-1990	80060	▲	410		4621001E12
----	-----------	-------	---	-----	--	------------

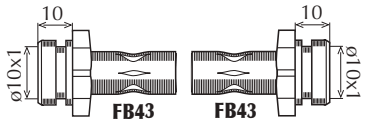
TT	1986-1990	80063	◀▶	310		4621401E00
----	-----------	-------	----	-----	---	------------

### BLUEBIRD (U11) WAGON (WU11)

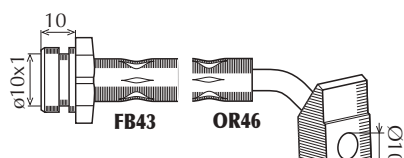
1.8, 1.8 Turbo, 2.0, 2.0 D	11/83-10/85	80059	▼	410		4621001E11
-------------------------------	-------------	-------	---	-----	--	------------

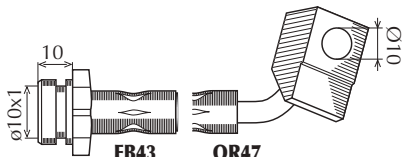
1.8, 1.8 Turbo, 2.0, 2.0 D	11/83-10/85	80060	▲	410		4621001E12
-------------------------------	-------------	-------	---	-----	--	------------

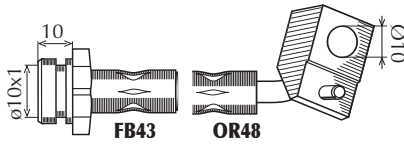
1.8, 1.8 Turbo, 2.0, 2.0 D	11/85-	80061	▼	395		4621011E11
-------------------------------	--------	-------	---	-----	--	------------

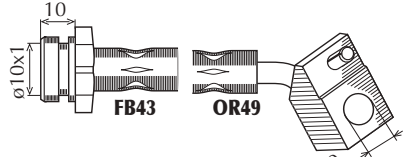
1.8, 1.8 Turbo, 2.0, 2.0 D	11/85-	80062	▲	395		4621011E12
-------------------------------	--------	-------	---	-----	--	------------

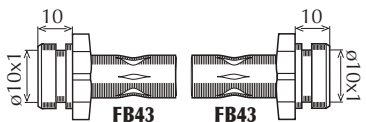
1.8, 1.8 Turbo, 2.0, 2.0 D	11/83-	80063	◀▶	310		4621401E00
-------------------------------	--------	-------	----	-----	--	------------



## TUBI FLESSIBILI PER FRENO



L



o.e.

### CUBE (Z12)

TT	03/10-	80815	▲		610		46210EM01B
TT	03/10-	80816	▼		610		46210EM01A
TT	03/10-	80817	▲		220		46210EM01E
TT	03/10-	80818	▼		225		46210EM01D

### KING CAB (D21)

TT 2WD	04/92-02/98	80082	▼		405		4621001G00
TT 2WD	04/92-02/98	80083	▲		400		4621101G00
TT 4WD	03/86-02/98	80084	▼		430		4621031G11
TT 4WD	03/86-02/98	80085	▲		345		4621131G11
TT 4WD (intermedio)	03/86-02/98	80272	○		538		4621032G10
TT 2WD	04/92-02/98	80387	◀▶		450		4621101A45
TT 4WD	03/86-02/98	80396	◀▶		495		4621101A60

Legenda/Legend: ○= Intermedio/Intermediate - ●= Interno/Inner - ▲= Superiore/Upper - ▼= Inferiore/Lower

## TUBI FLESSIBILI PER FRENO



L



o.e.

### JUKE

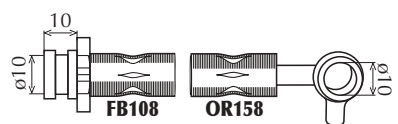
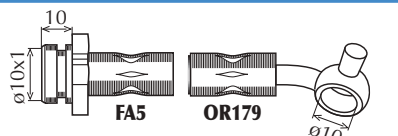
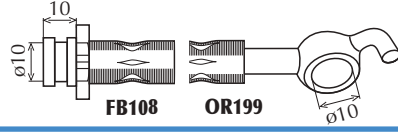
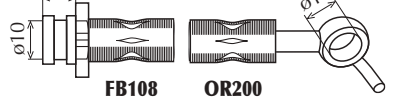
TT	06/10-	<b>80931</b>	◁		645	 <p>FB108 OR158</p>	462111KK0A
TT	06/10-	<b>80932</b>	▷		650	 <p>FA5 OR179</p>	462101KK0A
TT	06/10-	<b>80933</b>		◁	210	 <p>FB108 OR199</p>	462101KA0C
TT	06/10-	<b>80934</b>		▷	210	 <p>FB108 OR200</p>	462101KA0B

### KUBISTAR

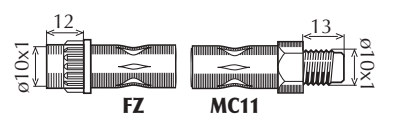
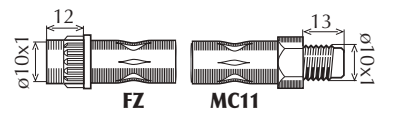
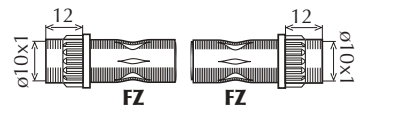
TT	03/98-	<b>8942</b>	◁ ▷		360	 <p>FZ MC11</p>	4620100Q0E
TT	03/98-	<b>8942</b>		◁	360	 <p>FZ MC11</p>	4620100Q0E
TT	03/98-	<b>8944</b>		▷	215	 <p>FZ FZ</p>	4621100QAA

### MICRA (K10)

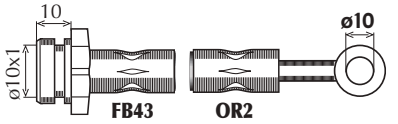
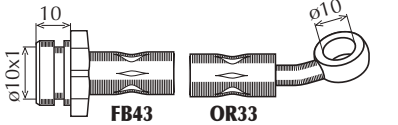
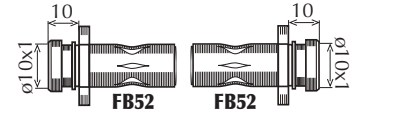
TT	12/82-03/89	<b>80064</b>		▷	555	 <p>FB43 OR2</p>	4621001B10
TT	04/89-07/92	<b>80065</b>		◁	550	 <p>FB43 OR33</p>	4621028B00
TT	12/82-07/92	<b>80066</b>		◁ ▷	293	 <p>FB52 FB52</p>	4621489914

## TUBI FLESSIBILI PER FRENO



L



o.e.

### MICRA (K11)

TT (- ABS)	08/92-	8993	<>		475		462105F002
TT (+ ABS)	08/92-	8995	<>		483		462105F006
TT (- ABS)	08/92-	8994	<>	<>	222		462145F000
TT (+ ABS)	08/92-	8996	<>	<>	234		462105F201

### MICRA (K12)

TT	01/03-	80573	>		615		46210AX601
TT	01/03-	80574	<		615		46210AX606
TT	01/03-	80575	<>	<>	305		46214AX600

### MICRA (K13)

TT	05/10-	80935	<		575		462111HJOB
TT	05/10-	80936	>		575	<b>FB92 OR252</b>	462101HJOB
TT	05/10-	80937	<>	<>	300		462101HJ5B

## TUBI FLESSIBILI PER FRENO



L



o.e.

### NAVARA (D40)

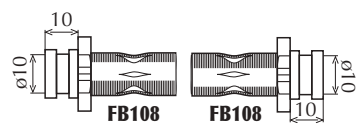
TT	10/04-	80926	<>	415		46210EB02A
----	--------	-------	----	-----	--	------------

### NOTE

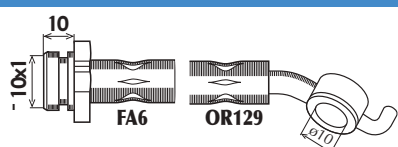
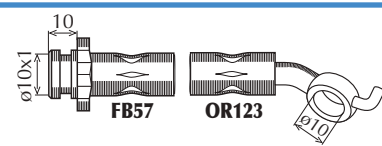
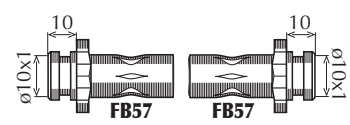
TT	03/06-	80573	▼	615		46210AX601
TT	03/06-	80574	▲	615		46210AX606
TT	03/06-	80575	<>	305		46214AX600

### PATHFINDER (R51)

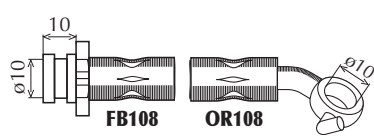
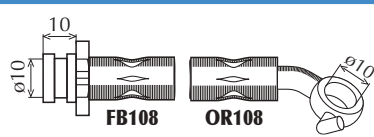
TT	01/05-	80685	▲	345		46211EB01A
TT	01/05-	80686	▼	345		46210EB01A

## TUBI FLESSIBILI PER FRENO



L



o.e.

### PATROL GR (Y60)

2.8 TD, 4.2	09/88-06/97	80071	▼		392		4621020J00
2.8 TD, 4.2	09/88-06/97	80072	▲		263		4621001J11
2.8 TD, 4.2 (intermedio)	09/88-06/97	80073		◀▶	225		4621002J10

### PATROL HARDTOP (K160)

2.8, 3.2 D, 3.2 TD	11/79-08/88	80074	▼		355		46201R8200
2.8, 3.2 D, 3.2 TD	11/79-08/88	80075	▲		413		46204C6000
2.8, 3.2 D, 3.2 TD	11/79-08/88	80076		◀▶	462		

### PATROL STATION WAGON (W160)

2.8, 3.2 D, 3.2 TD	11/79-08/88	80074	▼		355		46201R8200
2.8, 3.2 D, 3.2 TD	11/79-08/88	80075	▲		413		46204C6000

## TUBI FLESSIBILI PER FRENO



L



o.e.

### PICK UP (720)

#### 1.8, 2.3 D

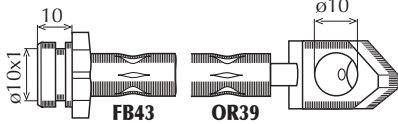
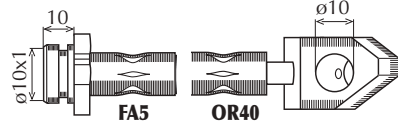
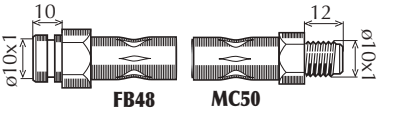
TT	01/83-03/86	80077	>		370		4621109W01
TT	01/83-03/86	80078	<		360		4621009W01
TT	01/83-03/86	80079	<>		438		4621179944

#### 2.2 4WD, 2.5 D 4WD

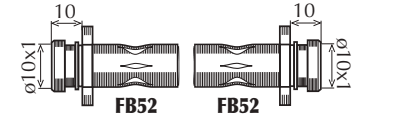
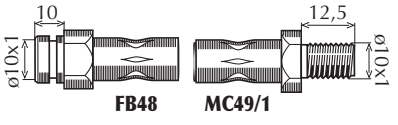
TT	04/83-03/86	80080	<>		260		4620489911
TT	04/83-03/86	80081	<>		559		4621179966

### PIXO (UA0)

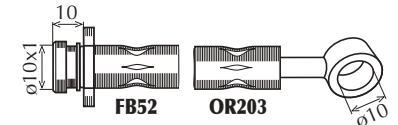
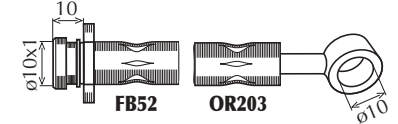
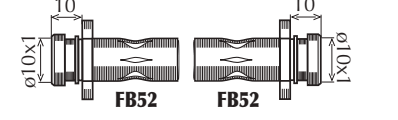
TT	03/09-	80823	<		465		462014A00E
TT	03/09-	80824	>		465		462014A00D
TT	03/09-	80825	<>		255		462114A00B

### PRAIRIE (M11)

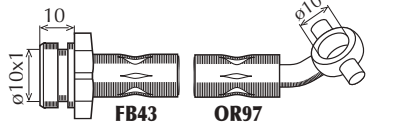
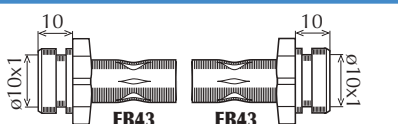
2.0, 2.0 4WD, 2.4, 2.4 4WD	10/88-07/94	80086	<>		505		4621030R10
2.0, 2.4	10/88-07/94	80087	<>		300		4621479915

## TUBI FLESSIBILI PER FRENO



L



o.e.

### segue PRAIRIE (M11)

2.0 4WD, 2.4 4WD	10/88-07/94	<b>80098</b>	<>	292		4621061A00
------------------	-------------	--------------	----	-----	--	------------

### PRIMERA (P10)

TT	06/90-09/94	<b>80088</b>	>	190/265		4621090J00
TT	06/90-09/94	<b>80089</b>	<	190/265		4621190J00
TT	10/94-06/96	<b>80576</b>	>	425		462102J008
TT	10/94-06/96	<b>80577</b>	<	425		462102J007
TT	06/90-06/96	<b>80090</b>	<>	310		4621490J00

### PRIMERA SW (W10)

TT	06/90-03/98	<b>80578</b>	<>	520		4621051E10
TT (Tamburo Post.)	06/90-03/98	<b>80100</b>	<>	325		4621401A17
TT (Disco Post.)	06/90-03/98	<b>80579</b>	<>	175		4621082N10

## TUBI FLESSIBILI PER FRENO



L



o.e.

### PRIMERA (P11)

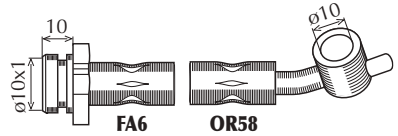
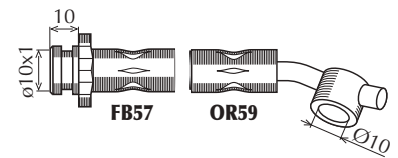
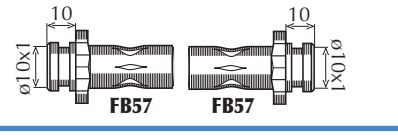
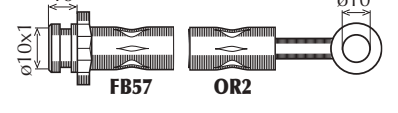
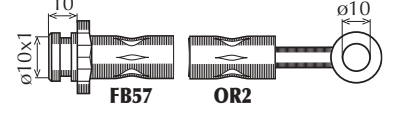
TT	07/96-	<b>80091</b>	▼		421		462102F001
TT	07/96-	<b>80092</b>	▲		421		462102F002
TT (Tamburo Post.)	07/96-	<b>80239</b>	◀▶		350		462142F001
TT (Disco Post.)	07/96-	<b>80093</b>	▼		600		462102F205
TT (Disco Post.)	07/96-	<b>80094</b>	▲		594		462102F206

### QASHQAI (J10, JJ10)

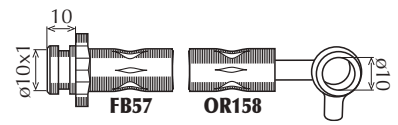
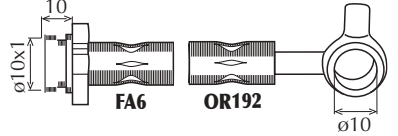
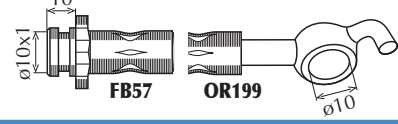
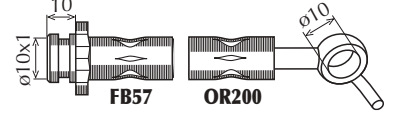
TT	01/05-	<b>80819</b>	▲		635		46210JD005
TT	01/05-	<b>80820</b>	▼		635		46210JD000
TT	01/05-	<b>80821</b>	▲		255		46210JD620
TT	01/05-	<b>80822</b>	▼		255		46210JD610

### SERENA

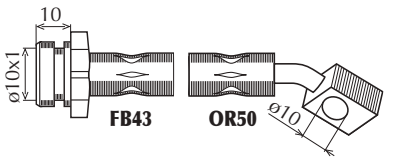
TT	11/92-	<b>80095</b>	◀▶		533		462109C501
----	--------	--------------	----	--	-----	--	------------



## TUBI FLESSIBILI PER FRENO



L



o.e.

### segue SERENA

TT (- ABS)	11/92-	<b>80096</b>	<>	300		462109C015
TT (+ ABS)	11/92-	<b>80268</b>	<>	270		462149C115

### SUNNY II (N13) Coupé (B12)

TT	06/86-06/91	<b>80097</b>	<>	520		4621060A10
TT (Tamburo)	06/86-06/91	<b>80098</b>	<>	292		4621061A00
TT (Pinza)	06/86-06/91	<b>80099</b>	<>	442		4621053A01

### SUNNY III (N14)

#### Liftback

1.4, 1.6, 2.0 D	10/90-05/95	<b>80054</b>	>	510		4621050Y07
1.4, 1.6, 2.0 D	10/90-05/95	<b>80053</b>	<	510		4621050Y12
1.4,1.6,2.0 D (+ ABS)	10/90-05/95	<b>80098</b>	<>	292		4621061A00
1.4, 1.6, 2.0 D (Imp.Hitachi)	10/90-05/95	<b>80080</b>	<>	260		4620489911

Legenda/Legend: ○= Intermedio/Intermediate - ●= Interno/Inner - ▲= Superiore/Upper - ▼= Inferiore/Lower

## TUBI FLESSIBILI PER FRENO



L



o.e.

### Hatchback

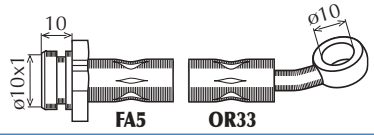
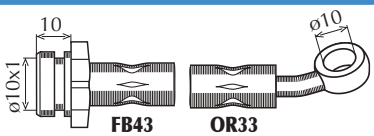
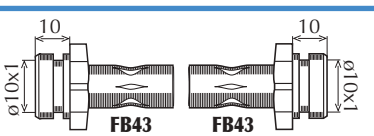
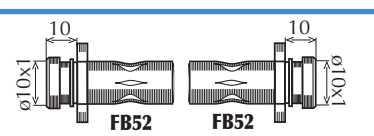
1.4, 1.6, 2.0 GTI, 2.0 4x4, 2.0 D	10/90-05/95	<b>80054</b>	▼		510		4621050Y07
1.4, 1.6, 2.0 GTI, 2.0 4x4, 2.0 D	10/90-05/95	<b>80053</b>	▲		510		4621050Y12
1.4, 1.6, 2.0 GTI, 2.0 4x4, 2.0 D (+ ABS)	10/90-05/95	<b>80098</b>		◀▶	292		4621061A00
1.4, 1.6, 2.0 GTI, 2.0 4x4, 2.0 D (Imp.Nichirin)	10/90-05/95	<b>80080</b>		◀▶	260		4620489911

### SUNNY (Y10)

#### VAN

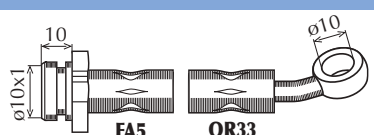
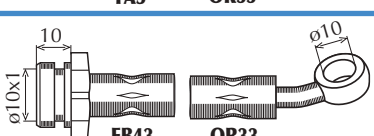
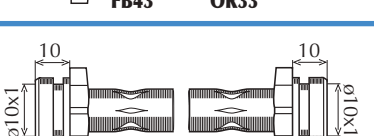
1.6, 1.7 D	05/92-04/96	<b>80054</b>	▼		510		4621050Y07
1.6, 1.7 D	05/92-04/96	<b>80053</b>	▲		510		4621050Y12
1.6, 1.7 D	05/92-04/96	<b>80100</b>		◀▶	325		4621401A17

#### SW

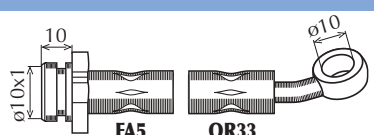
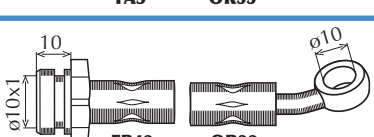
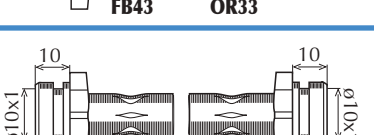
1.6, 1.6 4WD, 2.0 D	06/91-	<b>80054</b>	▼		510		4621050Y07
1.6, 1.6 4WD, 2.0 D	06/91-	<b>80053</b>	▲		510		4621050Y12
1.6, 1.6 4WD, 2.0 D	06/91-	<b>80100</b>		◀▶	325		4621401A17

## TUBI FLESSIBILI PER FRENO



L



o.e.

### TERRANO (WD21)

2.4 4WD, 2.7 TD 4WD, 3.0 4WD	10/87-02/93	<b>80084</b>	▼		430		4621050Y07
2.4 4WD, 2.7 TD 4WD, 3.0 4WD	10/87-02/93	<b>80085</b>	▲		345		4621050Y12
2.4 4WD, 2.7 TD 4WD (Imp. Nichirin)	10/87-02/93	<b>80101</b>	<>		410		4621101A41

### TERRANO II (R20)

2.4 4WD, 2.7 TD 4WD, 2.7 Tdi 4WD	02/93-	<b>80084</b>	▼		430		4621050Y07
2.4 4WD, 2.7 TD 4WD, 2.7 Tdi 4WD	02/93-	<b>80085</b>	▲		345		4621050Y12
2.4 4WD, 2.7 TD 4WD, 2.7 Tdi 4WD	02/93-	<b>80102</b>	<>		462		462110F015

### URVAN Bus (E23)

2.0, 2.3 D	12/82-11/88	<b>80074</b>	▼		355		46201R8200
------------	-------------	--------------	---	--	-----	--	------------

### VANETTE BUS (C22)

TT	10/86-12/89	<b>80103</b>	▼		465		46211G5110
TT	10/86-12/89	<b>80104</b>	▲		465	grande	46210G5110
TT	01/90-12/95	<b>80105</b>	▼		470		46210Y9501

Legenda/Legend: ○= Intermedio/Intermediate - ●= Interno/Inner - ▲= Superiore/Upper - ▼= Inferiore/Lower

## TUBI FLESSIBILI PER FRENO



L



o.e.

### segue VANETTE BUS (C22)

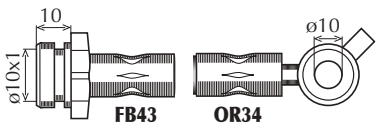
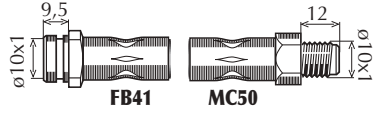
TT	01/90-12/95	<b>80106</b>	◁		470		46211Y9600
TT	10/86-12/95	<b>80107</b>	◁▷		420		46201Y9502

### X-TRAIL I (T30)

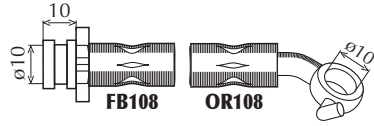
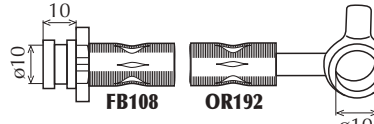
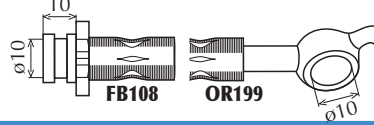
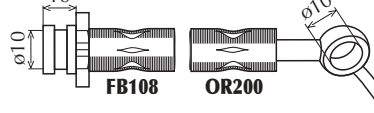
TT	06/07-	<b>80927</b>	◁		515		462108H30B
TT	06/07-	<b>80928</b>	▷		515		462108H30A
TT	06/07-	<b>80929</b>	◁		495		462108H51B
TT	06/07-	<b>80930</b>	▷		495		462108H51A

### X-TRAIL II (T31)

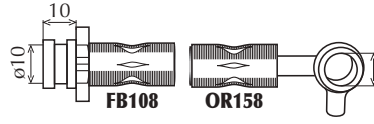
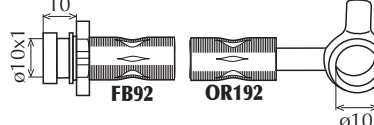
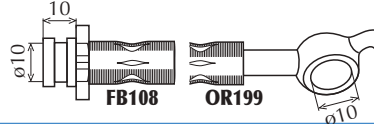
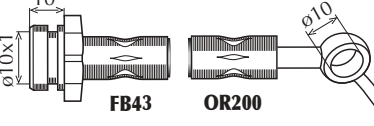
TT	06/07-	<b>80687</b>	◁		635		46210JG01B
TT	06/07-	<b>80688</b>	▷		640		46210JG01A
TT	06/07-	<b>80689</b>	◁		255		46210JG013
TT	06/07-	<b>80690</b>	▷		255		46210JG012

## TUBI FLESSIBILI PER FRENO



L



o.e.

### NISSAN COMMERCIALI CABSTAR (F22)

TT	12/81-9/92	<b>80074</b>	<>		355		46201R8200
----	------------	--------------	----	--	-----	--	------------

### INTERSTAR

TT	09/03-08/06	<b>80206</b>	<>		582		46201-00QAH
TT (Disco Post.) (Inferiore)	07/98-08/03	<b>80587</b>			535		46201-00QAD
TT (Disco Post.) (Superiore)	07/98-08/03	<b>80588</b>			510		46201-00QAC
TT (centrale)	07/98-08/06	<b>80208</b>		○	433		46204-00QAA
TT (Disco Post.)	07/98-08/06	<b>80211</b>	<>		355		46201-00QAE

### PRIMASTAR

TT	03/01-	<b>80200</b>	<>		415		4624200QAA
TT	03/01-	<b>80201</b>	<>		230		4621300QAA
TT (alla pinza)	03/01-	<b>80252</b>	<>		250		4621300QAC

## TUBI FLESSIBILI PER FRENO



L



o.e.

### TRADE

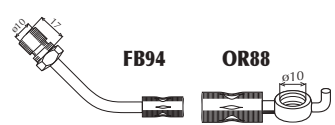
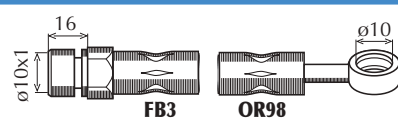
2.3 D, 3.0 TDiC	06/01-10/01	<b>80636</b>	< >				46210F3600
3.0 TDiC (Autobus)	06/01-10/01	<b>80638</b>	< >		440		46210F3600

### VANETTE VAN (C22)

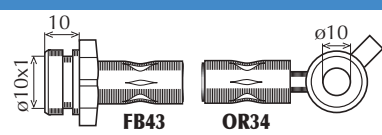
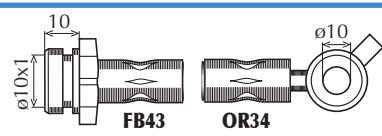
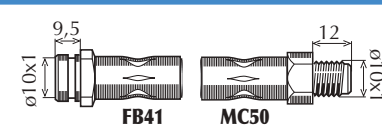
2.0 D	07/91-01/95	<b>80105</b>	▼		470		46210Y9501
2.0 D	07/91-01/95	<b>80106</b>	▲		470		46211Y9600
2.0 D	07/91-01/95	<b>80107</b>	< >		420		46201Y9502

## TUBI FLESSIBILI PER FRENO



L



o.e.

### AGILA

TT	09/00-	8932	<>		440		4700362
TT	09/00-	8933	<>		305		4701124

### AGILA (Mod. 2007)

TT	09/07-	80826	<>		525		4709839
TT	09/07-	80827		▲	330		4709848
TT	09/07-	80828		▼	325		4709847

### ANTARA

TT	06/06-	80659		▲	485		4808600
TT	06/06-	80660		▼	485		4808601
TT	06/06-	80661		▼	500		4804781
TT	06/06-	80662		▲	500		4804782

Legenda/Legend: ○= Intermedio/Intermediate - ●= Interno/Inner - ▲= Superiore/Upper - ▼= Inferiore/Lower

# TUBI FLESSIBILI PER FRENO



L



o.e.

## ASCONA A

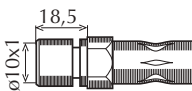
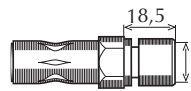
TT	10/70-02/75	8214	<>		385	 FB12	 FB12	562467
----	-------------	------	----	--	-----	--	---	--------

## ASCONA B

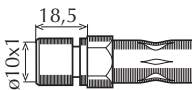
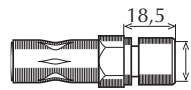
TT	10/74-07/81	8213	<>		410	 FB12	 FB12	562472
----	-------------	------	----	--	-----	--	---	--------

TT (Pinza flottante)	09/78-07/81	8545	<>		310	 FB3/1	 OR1	562345
----------------------	-------------	------	----	--	-----	---	--	--------

## ASCONA C

### (08/81->07/85)

TT	08/81-07/85	8543	<>		350	 FB25	 OR1	562325
----	-------------	------	----	--	-----	--	--	--------

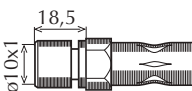
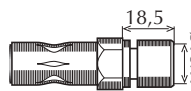
TT	08/81-07/85	8223	<>		195	 FB12	 FB12	562321
----	-------------	------	----	--	-----	--	---	--------

### (08/85->08/88)

TT	08/85-08/88	8545	<>		310	 FB3/1	 OR1	562345
----	-------------	------	----	--	-----	---	--	--------

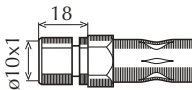
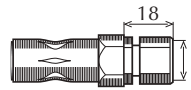
TT	08/85-08/88	8541	<>		195	 FB3/1	 FB3/1	562346
----	-------------	------	----	--	-----	---	--	--------

## ASTRA F

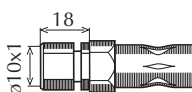
TT	09/91-09/98	8545	<>		310	 FB3/1	 OR1	562345
----	-------------	------	----	--	-----	---	--	--------

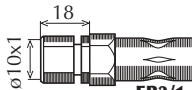
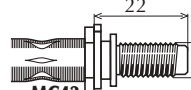
TT Berlina	09/91-09/98	8614	<>		235	 FB3/1	 MC43	562359
------------	-------------	------	----	--	-----	---	---	--------

TT SW	09/91-09/98	8541	<>		195	 FB3/1	 FB3/1	562346
-------	-------------	------	----	--	-----	---	--	--------



## TUBI FLESSIBILI PER FRENO



L



o.e.

### ASTRA G

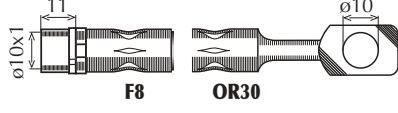
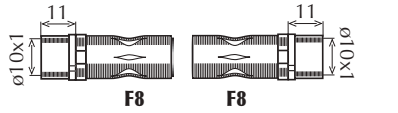
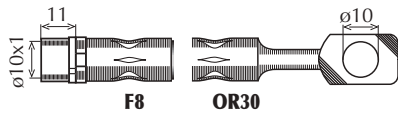
TT	02/98-	<b>8934</b>	<>		396		562377
1.2 16V, 1.4 16V, 1.6 16V, 1.7 TD, 1.7 DTI	02/98-	<b>8935</b>	<>		207		5562078
1.8 16V, 2.0 16V, 2.0 DTI (82, 101 CV)	02/98-	<b>8936</b>	<>		224		5562079

### ASTRA H

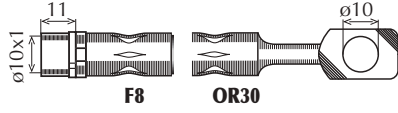
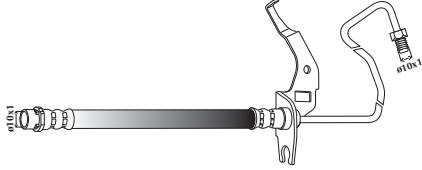
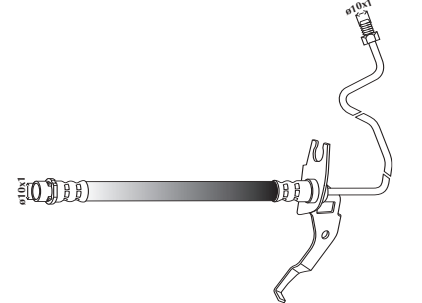
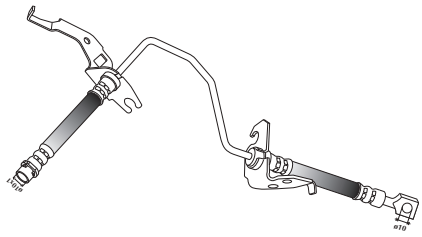
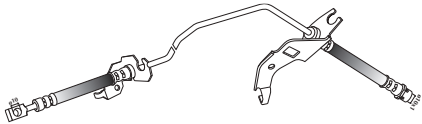
TT	03/04-	<b>80277</b>	<>		440		5562260
TT (Tamburo Post.)	03/04-	<b>80580</b>		▼			5562250
TT (Tamburo Post.)	03/04-	<b>80581</b>		▲			5562249
TT (Disco Post.)	03/04-	<b>80582</b>		▼			5562248
TT (Disco Post.)	03/04-	<b>80583</b>		▲			5562247

Legenda/Legend: ○= Intermedio/Intermediate - ●= Interno/Inner - ▲= Superiore/Upper - ▼= Inferiore/Lower

# TUBI FLESSIBILI PER FRENO



L





o.e.

## segue ASTRA H

TT (alla pinza)	07/05-	8936	<>	224		5562079
-----------------	--------	------	----	-----	--	---------

## ASTRA J

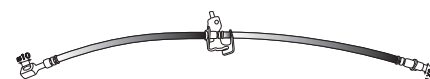
TT	12/09-	80832	<>	415		564016
TT	12/09-	80833	<			562130
TT	12/09-	80834	>			562131

## CALIBRA

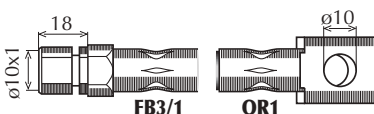
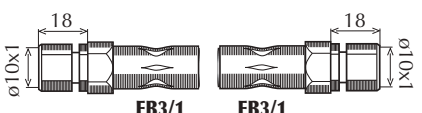
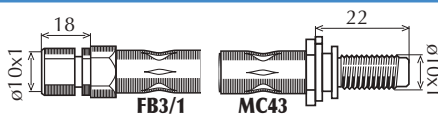
TT	10/89-07/97	8545	<>	310		562345
TT	10/89-07/92	8541	<>	195		562346
TT	08/92-07/97	8614	<>	235		562352

## CORSA A

### (09/82->07/85)

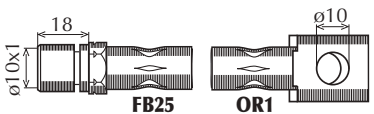
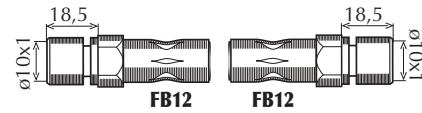
TT	09/82-07/85	8542	<>	280		562328
TT	09/82-07/85	8223	<>	195		562321

### (08/85->03/93)

TT	08/85-03/93	8540	<>	305		562343
----	-------------	------	----	-----	--	--------

## TUBI FLESSIBILI PER FRENO



L



o.e.

### segue CORSA A

segue (08/85->03/93)

TT	08/85-03/93	8541	<>	195	<p>FB3/1    FB3/1</p>	562346
----	-------------	------	----	-----	-----------------------	--------

### CORSA B

TT	03/93-09/00	8615	<>	340	<p>FB3/1    OR19</p>	562095
TT	03/93-09/00	8541	<>	195	<p>FB3/1    FB3/1</p>	562346

### CORSA C

TT	09/00-	8937	<>	310	<p>F8    OR50</p>	5562230
TT	09/00-	8938	<>	220	<p>F8    F8</p>	562302

### CORSA D

TT	07/06-	80188	<>	425	<p>FB23    MC11</p>	562275
TT (Tamburo Post.)	07/06-	80580	▼			5562250
TT (Tamburo Post.)	07/06-	80581	▲			5562249

Legenda/Legend: ○= Intermedio/Intermediate - ●= Interno/Inner - ▲= Superiore/Upper - ▼= Inferiore/Lower

# TUBI FLESSIBILI PER FRENO



L



o.e.

## segue CORSA D

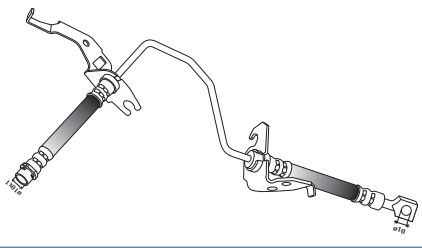
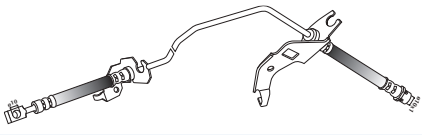
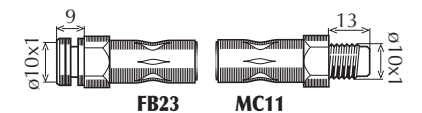
TT (Disco Post.)	07/06-	80582		▼			5562248
TT (Disco Post.)	07/06-	80583		▲			5562247
TT (alla pinza)	07/06-	80186		◀▶	162		562274

## FRONTERA A

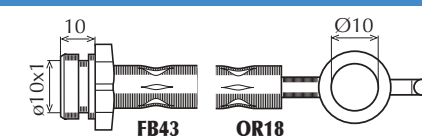
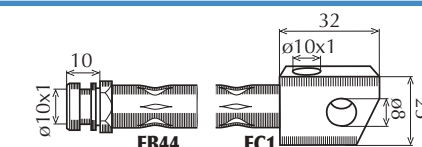
TT	03/92-10/98	8617		◀▶	435		562304
TT	03/92-10/98	8618		◀▶	468		562307

## FRONTERA B

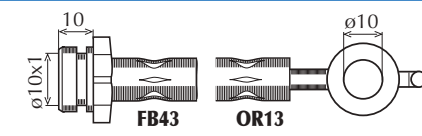
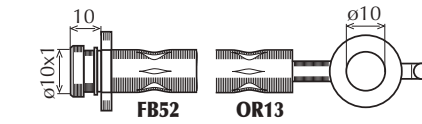
TT	10/98-	80237		◀▶	435		562339
TT	10/98-	80260		◀▶	193		562378

## INSIGNIA

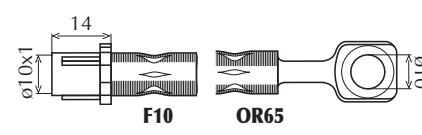
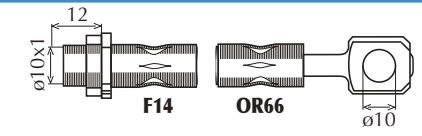
TT (Ruote 16")	07/08-	80829		◀▶	505		562129
TT (Ruote 18")	07/08-	80830		◀▶	490		562128

## TUBI FLESSIBILI PER FRENO



L



o.e.

### segue INSIGNIA

TT	07/08-	80831	<>	375	<p>F10 OR36</p>	562147
----	--------	-------	----	-----	-----------------	--------

### KADETT B

TT	09/65-07/73	8210	<>	230	<p>FB12 MC49/1</p>	562466
----	-------------	------	----	-----	--------------------	--------

### KADETT C

TT (Freno a tamburo)	08/73-07/79	8211	<>	360	<p>FB12 MC49/1</p>	562453
----------------------	-------------	------	----	-----	--------------------	--------

TT (Freno a disco)	08/73-07/79	8220	<>	370	<p>FB12 FB12</p>	562306
--------------------	-------------	------	----	-----	------------------	--------

### KADETT D

TT	08/79-07/84	8543	<>	350	<p>FB25 OR1</p>	562325
----	-------------	------	----	-----	-----------------	--------

TT	08/79-07/84	8223	<>	195	<p>FB12 FB12</p>	562321
----	-------------	------	----	-----	------------------	--------

### KADETT E

(08/84->07/85)

TT	08/84-07/85	8543	>	350	<p>FB25 OR1</p>	562325
----	-------------	------	---	-----	-----------------	--------

TT	08/84-07/85	8544	>	340	<p>FC OR1</p>	562336
----	-------------	------	---	-----	---------------	--------

TT	08/84-07/85	8223	<>	195	<p>FB12 FB12</p>	562321
----	-------------	------	----	-----	------------------	--------

# TUBI FLESSIBILI PER FRENO



L



o.e.

## segue KADETT E

(09/85->09/91)

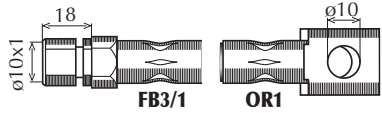
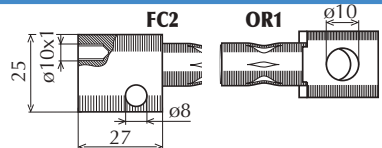
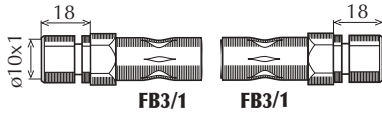
TT	09/85-09/91	8545	▼		310		562345
TT	09/85-09/91	8549	▲		325		562344
TT	09/85-09/91	8541	<>		195		562346

## MERIVA

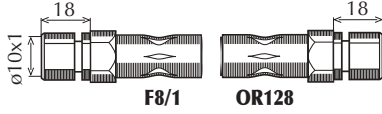
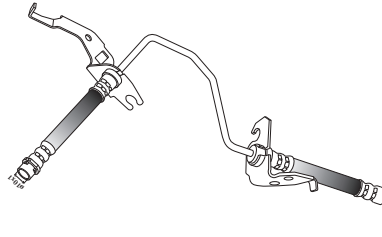
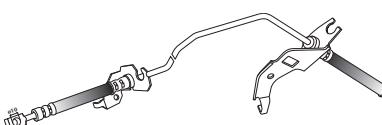
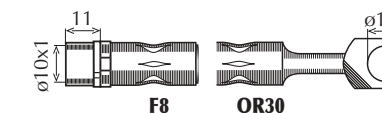
TT	05/03-	80584	<>		330		5562245
TT	05/03-	80582	▼				5562248
TT	05/03-	80583	▲				5562247
TT (alla pinza)	05/03-	8936	<>		224		5562079

## MERIVA B

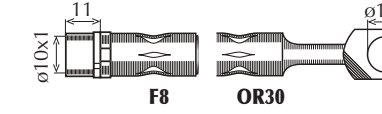
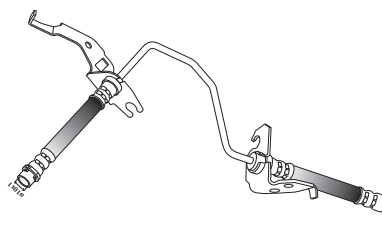
TT	03/10-	80277	<>		440		562161
TT	03/10-	80582	▼				5562248

## TUBI FLESSIBILI PER FRENO



L



o.e.

### segue MERIVA B

TT	03/10-	80583	<				5562247
----	--------	-------	---	--	--	--	---------

### OMEGA B

TT	03/94-07/03	80334	<>		440		562042
TT	03/94-07/03	8541	<>		195		562346

### REKORD D

TT	01/72-08/77	8218	<>		455		562447
TT	01/72-08/77	8219	<>		320		562446

### REKORD E

TT	08/77-09/86	8221	<>		330		562314
----	-------------	------	----	--	-----	--	--------

### SIGNUM

TT	05/03-	80340	<>		425		5562203
TT	05/03-	80342	<>		330		5562204

### SINTRA

TT	11/96-04/99	80585	<>		400		562369
----	-------------	-------	----	--	-----	--	--------

Legenda/Legend: ○= Intermedio/Intermediate - ●= Interno/Inner - ▲= Superiore/Upper - ▼= Inferiore/Lower

# TUBI FLESSIBILI PER FRENO



L



o.e.

## segue SINTRA

TT	11/96-04/99	80586	<>	185	normale	562374
----	-------------	-------	----	-----	---------	--------

## TIGRA

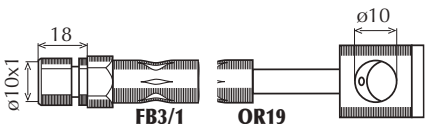
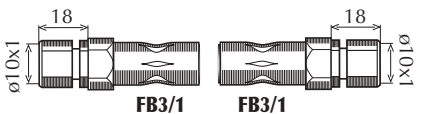
TT	07/94-	8615	<>	340	 FB3/1 OR19	562095
TT	07/94-	8541	<>	195	 FB3/1 FB3/1	562346

## TIGRA TWIN TOP

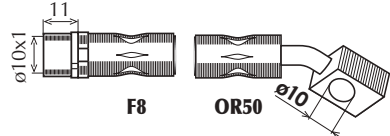
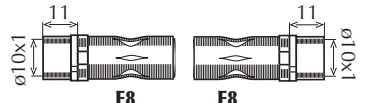
TT	07/04-	8937	<>	310	 F8 OR50	5562230
TT	07/04-	8938	<>	220	 F8 F8	562302

## VECTRA A

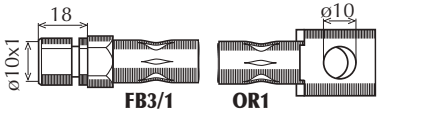
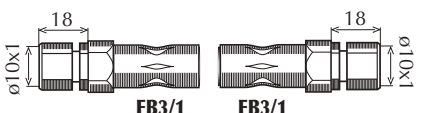
TT	09/88-11/95	8545	<>	310	 FB3/1 OR1	562345
TT	09/88-11/95	8541	<>	195	 FB3/1 FB3/1	562346

## VECTRA B

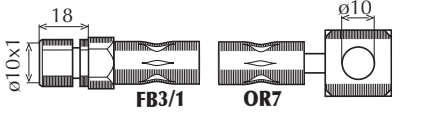
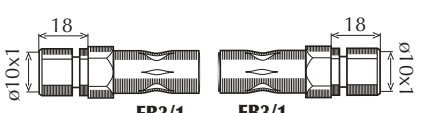
TT	10/95-	8619	<>	410	 FB3/1 OR7	562373
TT	10/95-	8541	<>	195	 FB3/1 FB3/1	562346



## TUBI FLESSIBILI PER FRENO



L



o.e.

### VECTRA C

TT	08/02-	80340	<>		425		5562203
TT	08/02-	80342	<>		330		5562204

### ZAFIRA

TT	04/99-	8934	<>		396		562377
TT	04/99-	8936	<>		224		5562079

### ZAFIRA II

TT	07/05-	80277	<>		440		5562260
TT	07/05-	80582		▼			5562248
TT	07/05-	80583		▲			5562247
TT (alla pinza)	07/05-	8936	<>		224		5562079

# TUBI FLESSIBILI PER FRENO



L



o.e.

## OPEL COMMERCIALI COMBO

(07/94->10/01)

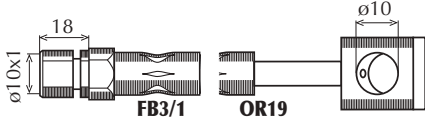
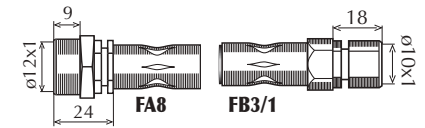
TT	07/94-10/01	8615	<>		340		562095
TT	07/94-10/01	80333	<>		410		562357

(10/01->)

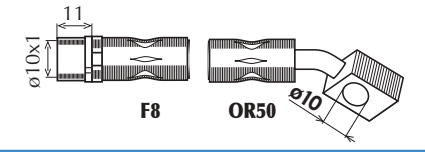
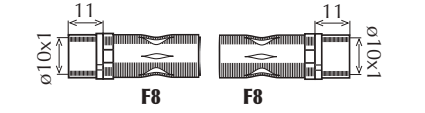
TT	10/01-	8937	<>		310		5562230
TT	10/01-	8935	<>		207		5562078

## KADETT E - KOMBI

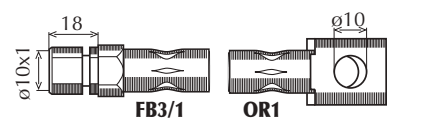
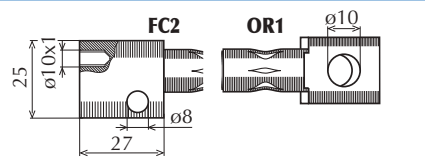
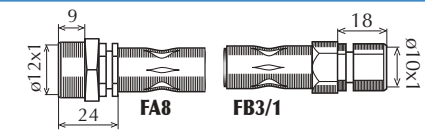
TT	09/85-91	8545	>		310		562345
TT	09/85-91	8549	<		325		562344
TT	09/85-91	80333	<>		410		562357

## MOVANO

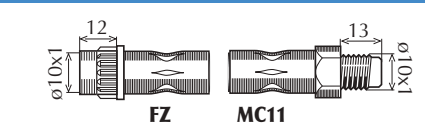
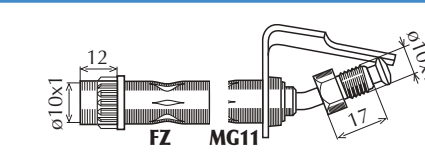
TT	09/03-08/06	80206	<>		582		4415698
TT (Tamburo Post.) (Inferiore)	07/98-08/03	80385	<>		615		4500131

## TUBI FLESSIBILI PER FRENO



L



o.e.

### segue MOVANO

TT (Tamburo Post.) (Superiore)	07/98-08/03	<b>80384</b>	< >		570		4500132
TT (Disco Post.) (Inferiore)	07/98-08/03	<b>80587</b>			535		4403643
TT (Disco Post.) (Superiore)	07/98-08/03	<b>80588</b>			510		4403645
TT (centrale)	07/98-08/06	<b>80208</b>	○		433		4500133
TT (Maxi)	07/98-08/06	<b>80207</b>	< >		270		
TT (Disco Post.)	07/98-08/06	<b>80211</b>	< >		355		4403662

### VIVARO

TT	08/01-	<b>80200</b>	< >		415		4416297
TT	08/01-	<b>80201</b>	< >		230		4409165
TT (alla pinza)	08/01-	<b>80252</b>	< >		250		4412727

Legenda/Legend: ○= Intermedio/Intermediate - ●= Interno/Inner - ▲= Superiore/Upper - ▼= Inferiore/Lower

## TUBI FLESSIBILI PER FRENO



o.e.

### 104

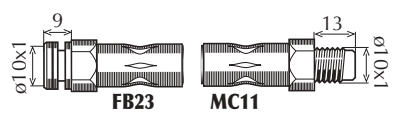
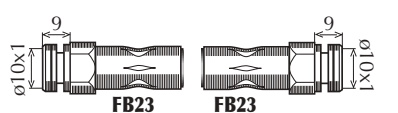
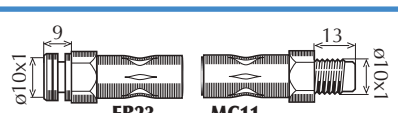
TT	07/75-83	8383	<>		370		480620
TT	07/75-83	8384	>		277		481623
TT	07/75-83	8385	<		297		481621

### 106

#### (09/92->02/96)

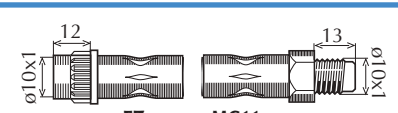
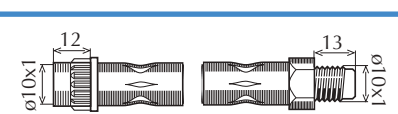
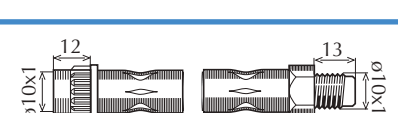
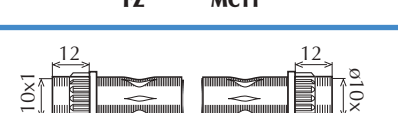
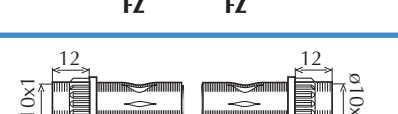
1.0, 1.1	09/92-02/96	8620	<>		355		480655
1.3, 1.6	09/92-03/95	8515	<>		315		480656
1.3, 1.6	03/95-02/96	8570	<>		325		480681
1.4, 1.3 D, 1.5 D	09/92-02/96	8515	<>		315		480656
TT	09/92-02/96	8516	>		220		480675
TT	09/92-02/96	8518	<		220		480661

#### (02/96->)

TT (Mod 96) Tamburo a 3-4 fori (-CH:O 07664)	03/96-	8570	<>		325		480681
--	--------	------	----	--	-----	--	--------

## TUBI FLESSIBILI PER FRENO



L



o.e.

### segue 106

#### segue (02/96->)

TT (Mod 96) Tamburo a 3-4 fori (CH:O 07664-)		<b>8515</b>	<>		315		480656
TT (Mod 96) Tamburo a 3 fori	03/96-	<b>8516</b>		▼	220		480675
TT (Mod 96) Tamburo a 3 fori	03/96-	<b>8518</b>		▲	220		480661
TT (Mod 96) T amburo a 4 fori	03/96-	<b>8518</b>		<>	220		480661

### 107

TT	06/05-	<b>80438</b>		▼	510		4806E2
TT	06/05-	<b>80439</b>		▲	510		4806E1
TT	06/05-	<b>80373</b>		<>	255		4806F6

### 204

TT	-08/75	<b>8325</b>		<>	375		480613
TT	-08/75	<b>8326</b>		<>	292		481609
TT	09/75-	<b>8383</b>		<>	370		480620

## TUBI FLESSIBILI PER FRENO



L









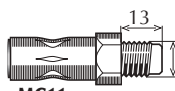
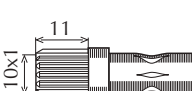
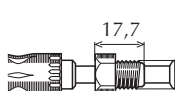

o.e.

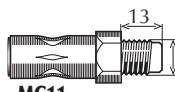
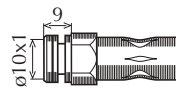
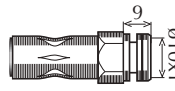

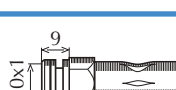

### segue 204

TT	09/75-	<b>8406</b>	<>	280	 	481624
----	--------	-------------	----	-----	--	--------

### 205

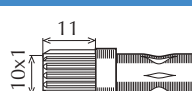
TT	02/83-10/87	<b>8528</b>	<>	350	 	480629
TT (- 1.9 GTI, 1.9 D)	11/87-96	<b>8534</b>	<>	460	 	480646
- 1.9 GTI, 1.9 D	11//87-96	<b>8528</b>	<>	350	 	480629
TT (- 1.6 Gti)	02/83-96	<b>8530</b>	<>	275	 	480653
1.6 Gti	12/84-10/87	<b>8530</b>	>	275	 	480653
1.6 Gti	12/84-10/87	<b>8532</b>	<	258	 	480632
1.9 Gti (alla pinza)	12/84-10/87	<b>80002</b>	<>	177	 	480652

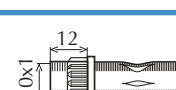
### 206

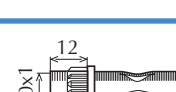
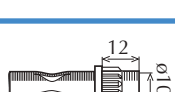
TT	09/98-	<b>8622</b>	<>	325	 	480692
TT	09/98-	<b>8516</b>	>	220	 	480694
TT	09/98-	<b>8501</b>	<	270	 	480693

## TUBI FLESSIBILI PER FRENO



L



o.e.

### 207

TT	02/06-	80349	<>		530		4806G1
TT	02/06-	80319	<>		220		4806G2

### 208

TT	03/12-	80741	<>		525		4806K7
TT	03/12-	80319	<>		220		4806G2

### 304

TT	-07/75	8325	<>		375		480613
TT	-07/75	8326	<>		292		481609
TT	07/75-80	8383	<>		370		480620
TT	07/75-80	8406	<>		280		481624

### 305

TT	07/82-90	8394	<>		367		480626
TT	07/82-90	8395	<>		233		481625

Legenda/Legend: ○ = Intermedio/Intermediate - ● = Interno/Inner - ▲ = Superiore/Upper - ▼ = Inferiore/Lower

## TUBI FLESSIBILI PER FRENO



L



o.e.



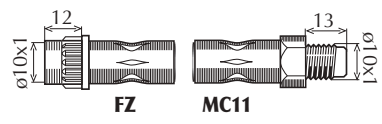
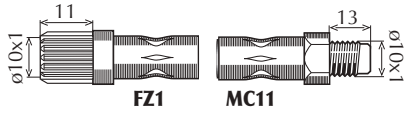
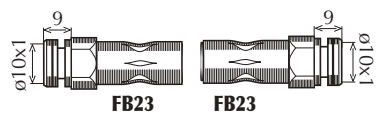
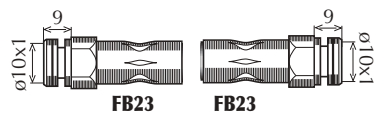

### 306

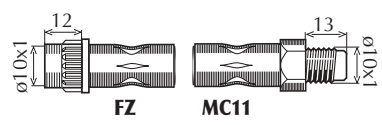
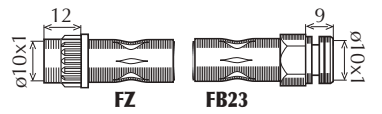
TT (Dischi pieni)	02/93-	<b>8625</b>	<>		535	 <p>FZ MC11</p>	480626
TT (Dischi ventilati)	02/93-	<b>8627</b>	<>		545	 <p>FZ1 MC11</p>	480663
TT	09/93-	<b>8626</b>		▼	265	 <p>FB23 FB23</p>	480664
TT	09/93-	<b>8548</b>		▲	230	 <p>FB23 FB23</p>	480665

### 308

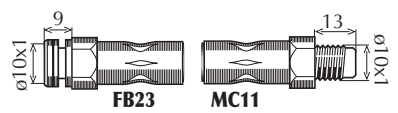
TT	09/07-	<b>80835</b>	<>		465	 <p>FZ MC11</p>	4806K1
TT	09/07-	<b>8941</b>		<>	210	 <p>FZ FB23</p>	4806A1

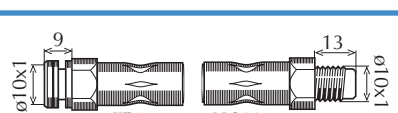
### 309

TT (Dischi pieni)	09/85-12/93	<b>8531</b>	<>		350	 <p>FB23 MC11</p>	480637
TT (Dischi pieni)	09/85-12/93	<b>8530</b>		▼	275	 <p>FB23 FB23</p>	481629
TT (Dischi pieni)	09/85-12/93	<b>8532</b>		▲	350	 <p>FB23 MC11</p>	480632
TT (Dischi ventilati)	09/85-12/93	<b>8529</b>	<>		435	 <p>FB23 MC11</p>	480631
TT (Dischi ventilati)	09/85-12/93	<b>8530</b>		<>	275	 <p>FB23 FB23</p>	481629



## TUBI FLESSIBILI PER FRENO



L



o.e.

### segue 309

TT (Dischi Ant/Post)	09/85-12/93	<b>8531</b>	<>		350		480637
TT (Dischi Ant/Post)	09/85-12/93	<b>8530</b>	<>		275		481629
1.9 Gti (alla pinza)	09/85-12/93	<b>80002</b>	<>		177		480652

### 404

TT	-75	<b>8245</b>	<>		340		480612
TT	-75	<b>8245</b>	>		340		480612
TT	-75	<b>8503</b>	>		470		481607

### 405

TT (-CH: 8043879)	06/87-	<b>8533</b>	<>		510		480639
TT (CH: 8043880-)	-10/96	<b>8534</b>	<>		460		480642
TT	06/87-10/96	<b>8535</b>	<>		215		480640
TT (alla pinza)	06/87-10/96	<b>8536</b>	<>		435		480641

Legenda/Legend: ○ = Intermedio/Intermediate - ● = Interno/Inner - ▲ = Superiore/Upper - ▼ = Inferiore/Lower

## TUBI FLESSIBILI PER FRENO



L



o.e.

### 406

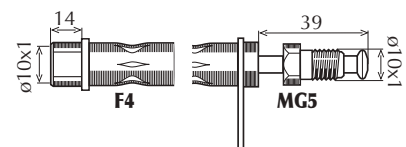
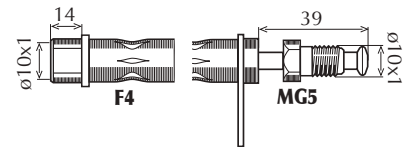
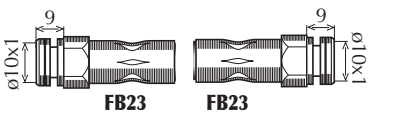
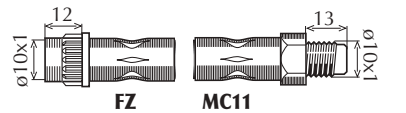
TT	10/95-10/04	<b>8628</b>	▼		575		480680
TT	10/95-10/04	<b>8629</b>	▲		575		480679
TT (Tamburo Post.)	10/95-10/04	<b>8630</b>	◀▶		305		480678
TT (Disco Post.)	10/95-10/04	<b>80205</b>	◀▶		562		4806A3

### 407

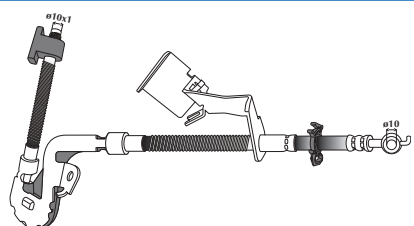
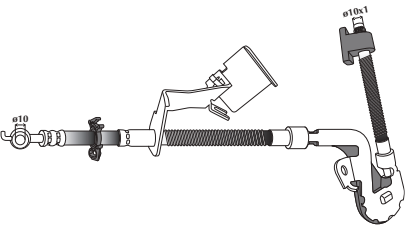
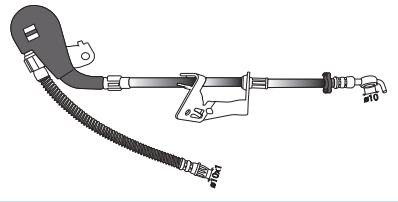
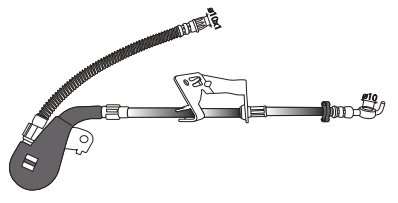
TT	05/04-	<b>80224</b>	▼				4806E5
TT	05/04-	<b>80223</b>	▲				4806E6
TT (+ ESP)	CH: 11126->	<b>80952</b>	▼				4806J4
TT (+ ESP)	CH: 11126->	<b>80953</b>	▲				4806J3

## TUBI FLESSIBILI PER FRENO



L



o.e.

### segue 407

TT	05/04-	80226	▼			4806E8
TT	05/04-	80225	▲			4806E7

### 504

(->08/75)

TT	-8/75	8245	<>	340		480612
TT	-8/75	8245	<>	340		480612
TT (alla pinza)	-8/75	8505	<>	247		481611

(09/75->86)

TT	09/75-86	8383	<>	370		480620
TT	09/75-86	8504	<>	401		480621
TT (alla pinza)	09/75-86	8506	<>	326		481620

### 505

TT (- 2.2 Turbo, 2.8)	82-92	8504	<>	401		480621
2.2 Turbo, 2.8	86-92	8529	<>	435		480631

Legenda/Legend: ○ = Intermedio/Intermediate - ● = Interno/Inner - ▲ = Superiore/Upper - ▼ = Inferiore/Lower

## TUBI FLESSIBILI PER FRENO



L



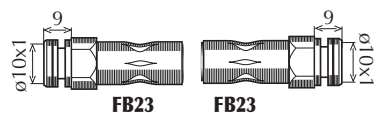
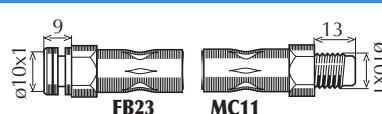

o.e.

### segue 505

TT Berlina	80-92	<b>8506</b>	<>	326		481620
TT SW	82-92	<b>8383</b>	<>	370		480620

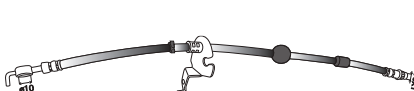
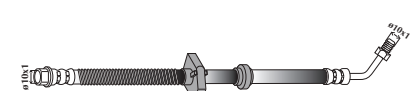
### 508

TT	11/10-	<b>81002</b>	▼			4806N3
TT	11/10-	<b>81003</b>	▲			4806N2
TT	11/10-	<b>80226</b>	▼			4806K3
TT	11/10-	<b>80225</b>	▲			4806K2

### 605

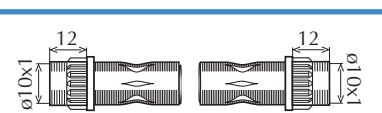
TT	10/89-01	<b>8939</b>	<>	565		480658
TT	10/89-01	<b>8535</b>	<>	215		480647

### 607

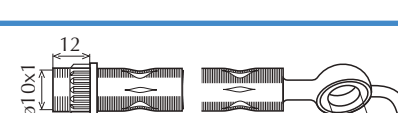
TT	02/00-07/04	<b>80203</b>	<>	600		480695
TT	08/04-	<b>80840</b>	<>	555		4806F4

## TUBI FLESSIBILI PER FRENO



L



o.e.

### segue 607

TT	02/00-07/04	<b>80204</b>	<>	228		480645
TT	08/04-	<b>80841</b>	<>	495		4806F5

### 806

TT	06/94-	<b>8569</b>	<>	515		480682
TT (intermedio)	06/94-	<b>8573</b>	○	275		480667
TT	06/94-	<b>8570</b>	<>	325		480668

### 807

TT (- 3.0 V6)	08/02-	<b>80007</b>	<>	490		1484536080
TT	08/02-	<b>8573</b>	<>	275		480667

### 1007

TT	04/05	<b>8485</b>	<>	465		480685
TT	04/05	<b>80004</b>	<>	205		4806C0

## TUBI FLESSIBILI PER FRENO



L



o.e.

### 3008

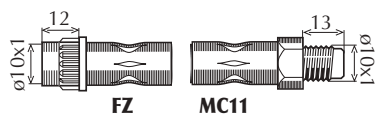
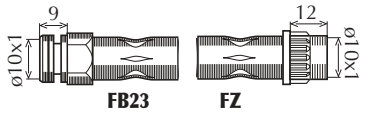
TT	06/09-	80835	<>		465	 <p>FZ MC11</p>	4806K1
TT	06/09-	8941	<>		210	 <p>FB23 FZ</p>	4806A1

### 4007

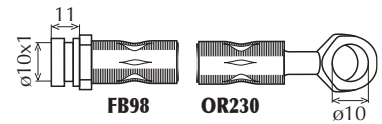
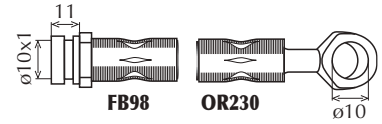
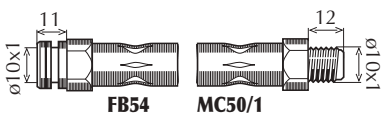
TT	02/07-	80663	<		630	 <p>FB98 OR230</p>	4806H8
TT	02/07-	80664	>		630	 <p>FB98 OR230</p>	4806H9
TT	02/07-	80665	<>		305	 <p>FB54 MC50/1</p>	4806J0

### 5008

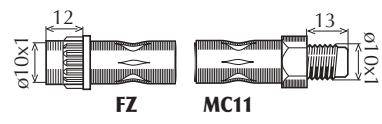
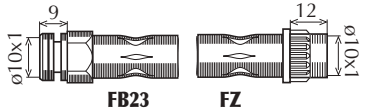
TT	09/09-	80835	<>		465	 <p>FZ MC11</p>	4806K1
TT	09/09-	8941	<>		210	 <p>FB23 FZ</p>	4806A1

## TUBI FLESSIBILI PER FRENO



o.e.

### BIPPER

TT	01/08-	80745	<>		430		4806J9
TT	01/08-	80842	<>		200		4806K0

### RANCH / PARTNER

TT	07/96-	8485	<>		465		480685
TT	07/96-CH:09533	8561	<>		255		480686
TT	CH:09534-	80227	<>		260		4806E3

### RANCH / PARTNER (Mod.2008)

TT	04/08-	80440	<>		445		4806G4
----	--------	-------	----	--	-----	--	--------

### PEUGEOT COMMERCIALI

#### 205 VAN

TT	09/83-	8528	<>		350		480629
TT	09/83-	8406	>		280		481624
TT	09/83-	8530	>		275		480653

## TUBI FLESSIBILI PER FRENO



L



o.e.

### 504 Pick Up

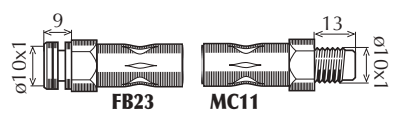
TT	09/75-	8383	<>		370	 <p>FB23 MC11</p>	480620
----	--------	------	----	--	-----	---	--------

### BOXER

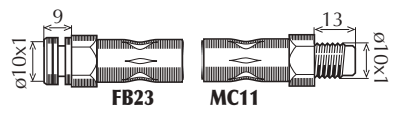
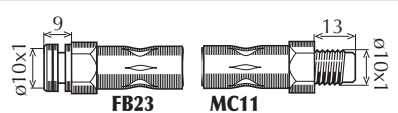
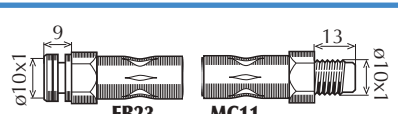
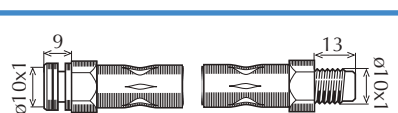
TT	02/94-	8571	<>		490	 <p>FB23 MC11</p>	480671
TT (-ABS)	02/94-	8531	<>	<>	350	 <p>FB23 MC11</p>	480672
TT (+ABS)	02/94-	8517	>	>	360	 <p>FB23 MC11</p>	480673
TT (+ABS)	02/94-	8425	<	<	335	 <p>FB23 MC11</p>	481636

### BOXER (Mod. 2002)

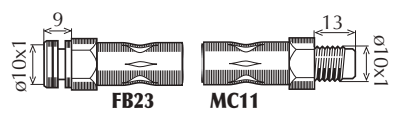
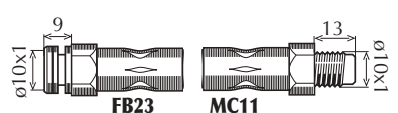
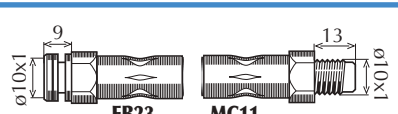
TT	11/01->	80183	<>		500	 <p>FB23 MC11</p>	4806F2
TT (centrale)	11/01->	80177		○	382	 <p>FB23 MC11</p>	4806C8
TT	11/01->	8459	<>	<>	182	 <p>FB23 MC11</p>	4806C4

### BOXER (Mod. 2006)

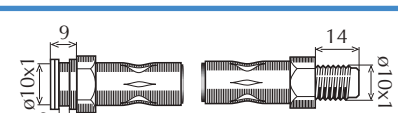
TT	07/06-	80243	<>		515	 <p>FB23 MC11</p>	ND
TT	07/06-	80284	<>	<>	440	 <p>FB79 MC55</p>	ND



## TUBI FLESSIBILI PER FRENO



o.e.

### segue BOXER (Mod. 2006)

TT (Carreggiata maggiorata)	07/06-	80285	<>	515		ND
--------------------------------	--------	-------	----	-----	--	----

### EXPERT

TT	02/96-	8569	<>	515		480682
TT (Intermedio)	02/96-	8573	○	275		480667
TT	02/96-	8570	<>	325		480668

### EXPERT (Mod. 2007)

TT	01/07-	80748	<>	510		4806H0
TT	01/07-	80749	<>	265		4806H5

### J5



TT ->CH:171999	10/81->	8365	<>	388		480624
TT (Superiore) CH:172000->	->94	8411	<>	460		480635
TT (Inferiore) CH:172000->	->94	8410	<>	460		480636
TT	10/81->94	8354	<>	284		481627

Legenda/Legend: ○ = Intermedio/Intermediate - ● = Interno/Inner - ▲ = Superiore/Upper - ▼ = Inferiore/Lower

**TUBI FLESSIBILI PER FRENO**

**L**

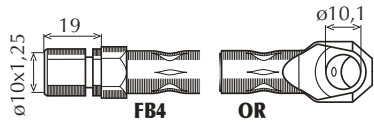
**o.e.**
**125 P - Polonez**

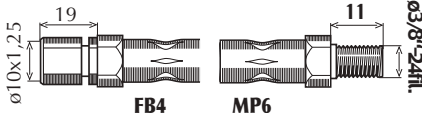
TT		<b>8281</b>	<>		370		4234920
TT (Intermedio)		<b>8019</b>		○	295		4234922
TT		<b>8083</b>	<>		175		4234923

**126 P**

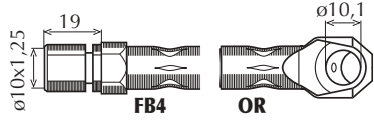
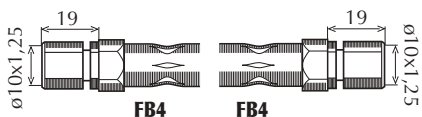
TT		<b>8144</b>	<>		285		4167826
TT		<b>8143</b>	<>		240		4167824

## TUBI FLESSIBILI PER FRENO



**o.e.**

### 914

TT	1970-1976	<b>8241</b>	<>		300		211611775A
TT	1970-1976	<b>8240</b>	<>		236		211611775B

### 924

2.0 Turbo, 2.5 S	11/78-	<b>80590</b>	<>		445		477611071B
2.0, 2.0 Turbo, 2.5 S	08/75-	<b>80591</b>	<>		225		477611775

### 944

2.5, 2.5 Turbo	06/81-	<b>80590</b>	<>		445		477611071B
2.5, 2.5 Turbo	06/81-	<b>80591</b>	<>		225		477611775

### 911 (996)

2.5, 2.5 Turbo	06/97-	<b>80592</b>	<>		320		99635513901
2.5, 2.5 Turbo	06/97-	<b>80592</b>	<>		320		99635513901

### 911 (997)

2.5, 2.5 Turbo	07/04-	<b>80592</b>	<>		320		99635513901
2.5, 2.5 Turbo	07/04-	<b>80592</b>	<>		320		99635513901

Legenda/Legend: ○ = Intermedio/Intermediate - ● = Interno/Inner - ▲ = Superiore/Upper - ▼ = Inferiore/Lower

## TUBI FLESSIBILI PER FRENO



L



o.e.

### 928 S

TT	08/77-	<b>8049</b>	<>	280		211611775C
----	--------	-------------	----	-----	--	------------

### BOXSTER (986)

TT	09/96-	<b>80592</b>	<>	320		99635513901
----	--------	--------------	----	-----	--	-------------

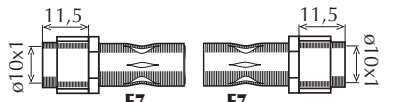
TT	09/96-	<b>80592</b>	<>	320		99635513901
----	--------	--------------	----	-----	--	-------------

### BOXSTER

TT	11/04-	<b>80592</b>	<>	320		99635513901
----	--------	--------------	----	-----	---	-------------

### CAYENNE (955)

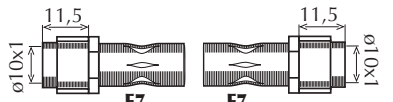
TT	09/02-	<b>80169</b>	<>	542		7L0611701A
----	--------	--------------	----	-----	--	------------

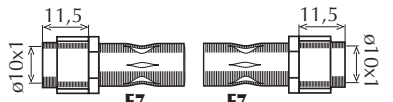
TT	09/02-	<b>80170</b>	<>	426		7L0611776
----	--------	--------------	----	-----	--	-----------

### CAYMAN

S 3.4	11/05-	<b>80592</b>	<>	320		99635513901
-------	--------	--------------	----	-----	--	-------------

## TUBI FLESSIBILI PER FRENO



L



o.e.

### CLIO I

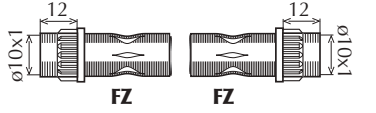
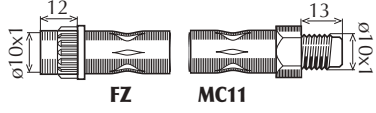
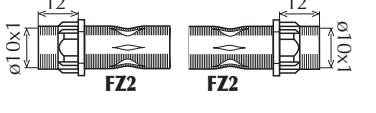
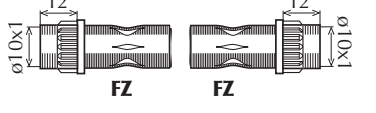
TT (- ABS)	01/91-09/98	8445	<>		267		7700804356
TT (-16V) (- ABS)	01/91-09/98	8446	<>		285		7700804814
TT (+ ABS)	01/91-09/98	8496	<>		270		7704003887
TT (-16V) (+ ABS)	01/91-09/98	8637	<>		190		7700416273
1.8 16V, 2.0 16V	01/91-09/98	8635	<>		245		7704001951

### CLIO II

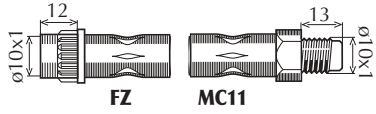
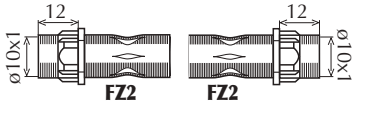
TT	09/98-	8636	<>		345		7700423975
1.2, 1.4, 1.4 16V, 1.6, 1.6 16V, 1.9 D	09/98-	8637	<>		190		7700416273

### CLIO III

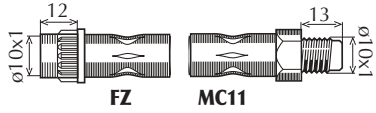
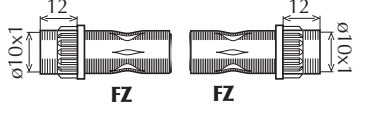
TT	06/05-	80212	<>		480		8200129954
TT	06/05-	80214	<>		213		8200249251

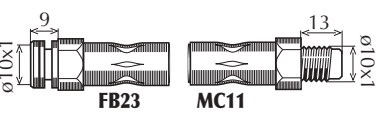

### ESPACE I

TT	85-12/90	8390	<>		405		7701349336
----	----------	------	----	--	-----	--	------------

**TUBI FLESSIBILI PER FRENO**

**L**

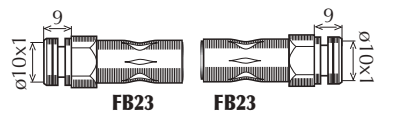
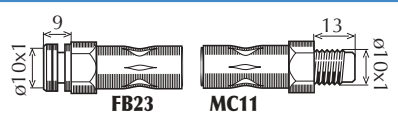
**o.e.**
**segue SPACE I**

TT (- ABS)	85-12/90	<b>8391</b>	<>	370		7704001932
TT (+ ABS)	85-12/90	<b>8392</b>	<>	315		7704001939
2.0, 2.2 Quadra	88-12/90	<b>8333</b>	<>	266		7701348912

**SPACE II**

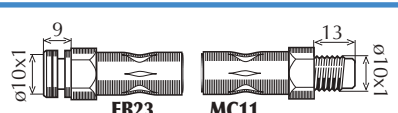
TT	01/91-10/96	<b>8992</b>	<>	420		7700845510
TT	01/91-10/96	<b>8392</b>	<>	315		7704001939

**SPACE III**

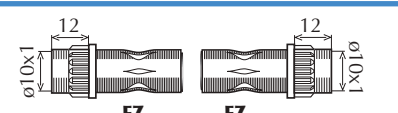
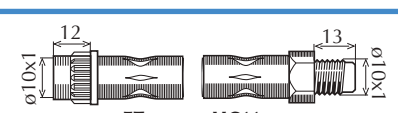
TT	11/96-10/02	<b>80257</b>	<>	540		6025310456
TT (centrale)	11/96-10/02	<b>80747</b>	○	210		6025307607
TT	11/96-10/02	<b>8494</b>	<>	290		6025307608

**SPACE IV**

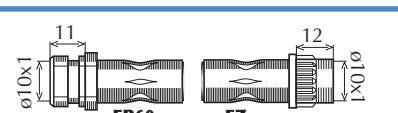
TT	11/02-	<b>80009</b>	<>	410		7701050070
TT	11/02-	<b>80010</b>	<>	210		7701050073

## TUBI FLESSIBILI PER FRENO



L



o.e.

### FUEGO

TT	80-86	8390	<>		405		7700423975
TT (intermedio)	80-86	8392		○	315		7701349337
TT	80-86	8391		<>	370		7704001932

### KANGOO

TT	03/98-	8943		▲	360		7700312022
TT	03/98-	8944		▼	215		7700304969
TT	03/98-	8942		▲	360		7700313596

### KANGOO (Mod.2008)

TT	02/08-	80746		<>	515		462107573R
TT	02/08-	80747		<>	210		8200572102

### KOLEOS

TT	09/08-	80687		▲	635		46210JG01B
TT	09/08-	80688		▼	640		46210JG01A

Legenda/Legend: ○ = Intermedio/Intermediate - ● = Interno/Inner - ▲ = Superiore/Upper - ▼ = Inferiore/Lower

**TUBI FLESSIBILI PER FRENO**

**L**

**o.e.**
**segue KOLEOS**

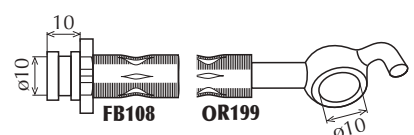
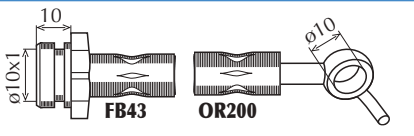
TT	09/08-	<b>80689</b>	◁	255		46210JG013
TT	09/08-	<b>80690</b>	▷	255		46210JG012

**LAGUNA I**

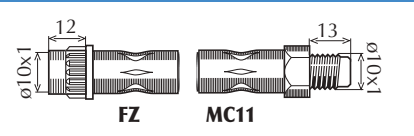
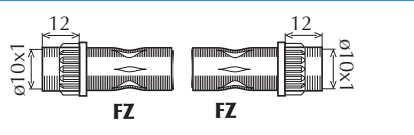
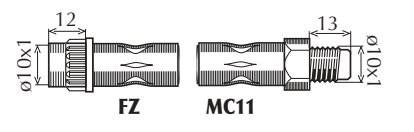
TT	11/93-03/01	<b>8631</b>	↔	480		7700834731
TT (- ABS)	11/93-03/01	<b>8444</b>	↔	305		7704003905
TT (+ ABS)	11/93-03/01	<b>8632</b>	↔	180		7704002443

**LAGUNA II**

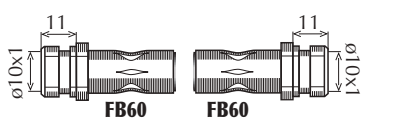
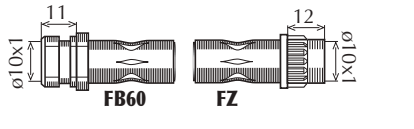
TT	03/01-	<b>80009</b>	↔	410		7701050070
TT	03/01-	<b>80010</b>	↔	210		7701050073

**LAGUNA III**

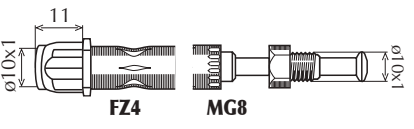
TT	10/07-	<b>80843</b>	↔	470		462100001R
----	--------	--------------	---	-----	--	------------

**MEGANE**

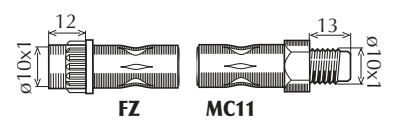
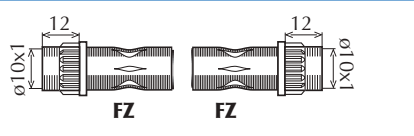
TT	01/96-	<b>8633</b>	↔	420		7700840390
TT	01/96-	<b>8495</b>	↔	280		7700834863



## TUBI FLESSIBILI PER FRENO



L



o.e.

### MEGANE II

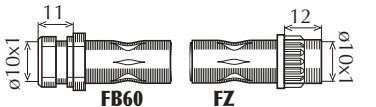
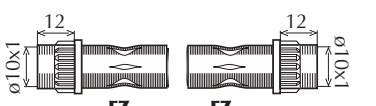
TT	11/02-	80213	<>		457		8200333851
TT	11/02-09/05	80309	<>		210		8200256166
TT	10/05-	80747	<>		210		8200572102

### MEGANE III

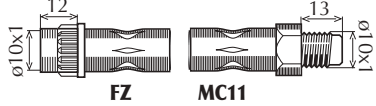
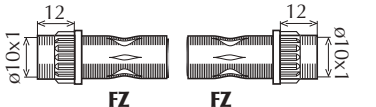
TT	11/08-	80846	<>		455		462100006R
TT	11/08-	80938	<>		160		462106659R

### MEGANE SCENIC

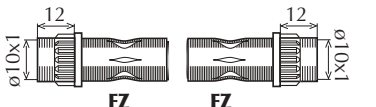
TT	01/96-	8633	<>		420		7700840390
TT	01/96-	8495	<>		280		7700834863

### MEGANE SCENIC II - GRAND SCENIC

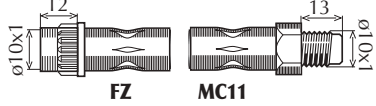
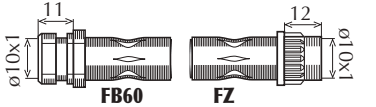
TT	06/03-	80213	<>		457		8200333851
TT	06/03-	80309	<>		210		8200256166

### MEGANE SCENIC III

TT	02/09-	80846	<>		455		462100006R
----	--------	-------	----	--	-----	--	------------

Legenda/Legend: ○ = Intermedio/Intermediate - ● = Interno/Inner - ▲ = Superiore/Upper - ▼ = Inferiore/Lower

## TUBI FLESSIBILI PER FRENO



L





o.e.



### segue MEGANE SCENIC III

TT	02/09-	80938	<>	160		462106659R
----	--------	-------	----	-----	--	------------



### MODUS

TT	12/04->	80212	<>	480		8200129954
TT	12/04->	80214	<>	213		8200249251

### R4

TT	-7/82	8096	<>	500		7701454835
TT	8/82-	8309	<>	460		7701348800
TT		8097	<>	270		7704001957

### R5

TT	07/71-06/82	8096	<>	500		7701454835
TT	07/82-85	8309	<>	460		7701348800
TT	07/71-85	8097	<>	270		7704001957

### R5 Super

TT	85-	8443	<>	330		7704003913
----	-----	------	----	-----	--	------------

## TUBI FLESSIBILI PER FRENO



L



o.e.

### segue R5 Super

TT (- GT, GTE, Turbo)	85-	<b>8444</b>	▼	305		7704003905
TT (- GT, GTE, Turbo)	85-	<b>8501</b>	<	270		7704003549
GT, GTE, Turbo	85-	<b>8501</b>	<>	270		7704003549

### R9 - R11

TT	81-90	<b>8500</b>	<>	375		7704001954
R9-R11 1.1, 1.2, 1.6 D	81-88	<b>8501</b>	<>	270		7704003549
R9 1.4 (L422, L42C) R11 (B/C/S372, B/C 37C)	81-88	<b>8501</b>	<>	270		7704003549
R9 1.4 (L423, L42R) R11 (B/C/S373, B/C 37R)	83-88	<b>8603</b>	<>	325		7704003764
1.4 Turbo / TT	84-90	<b>8446</b>	<>	285		7700804814
R9 1.7 (L423) (L42F ->CH:D00000525), (L426 ->CH:H00005600)		<b>8603</b>	<>	325		7704003764
R9 1.7 (L42N/E) (L42F CH:D00000526-), (L426 ->CH:H00005601-)		<b>8446</b>	<>	285		7700804814
R11 1.7 (B/C 37F/D/N, 376)		<b>8603</b>	<>	325		7704003764

Legenda/Legend: ○ = Intermedio/Intermediate - ● = Interno/Inner - ▲ = Superiore/Upper - ▼ = Inferiore/Lower

**TUBI FLESSIBILI PER FRENO**

**L**

**o.e.**
**segue R9 - R11**

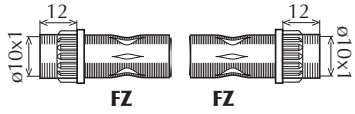
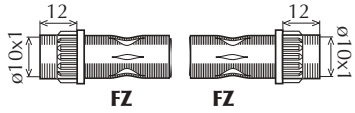
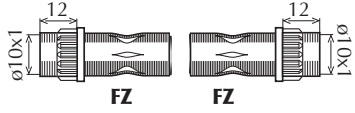
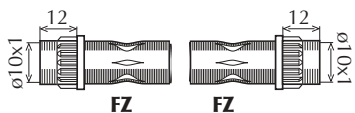
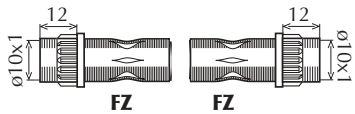
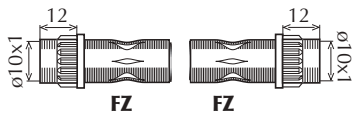
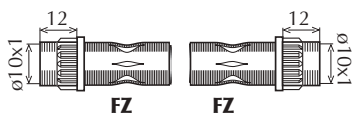
R11 1.7 (B/C 37F/D/N)	-12/88	<b>8501</b>	<>	270		7704003549
R11 1.7 (B/C 376 -CH:H00017726 /CH:00006418)	10/83-	<b>8603</b>	<>	325		7704003764
R11 1.7 (B/C 37F CH:H00017727-)	-12/87	<b>8446</b>	<>	285		7700804814
R11 1.7 (B/C 37F CH:00006419-)	-12/87	<b>8501</b>	<>	270		7704003549
R11 1.7 (B/C 37F -CH:D00000644 /CH:00000509)	10/84-	<b>8603</b>	<>	325		7704003764
R11 1.7 (B/C 37F CH:D00000645-)	-12/88	<b>8446</b>	<>	285		7700804814
R11 1.7 (B/C 37F CH:00000510-)	-12/88	<b>8501</b>	<>	270		7704003549

**R12**

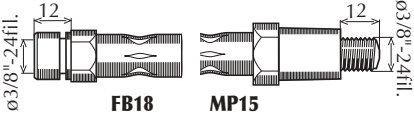
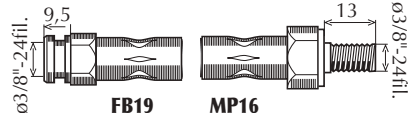
1.3	08/72-08/80	<b>8323</b>	<>	345		7701454063
1.3	08/72-08/80	<b>8324</b>	<>	325		7701452077

**R14**

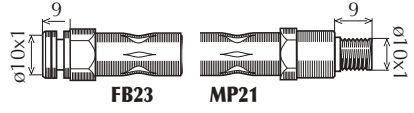
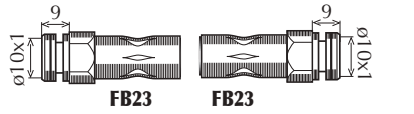
TT (CH:570871-)	77-08/83	<b>8332</b>	<>	320		7701349111
TT (CH:570871-)	77-08/83	<b>8333</b>	<>	266		7701348912

## TUBI FLESSIBILI PER FRENO



L



o.e.

### R15

1.3	03/72-10/80	8323	<>		345	<p>12 12 3/8" x 24 fil.</p> <p><b>FB18</b>    <b>MP15</b></p>	7701454063
1.3	03/72-10/80	8324	<>		325	<p>9.5 13 3/8" x 24 fil.</p> <p><b>FB19</b>    <b>MP16</b></p>	7701452077

### R16

1.5, 1.6	07/71-08/80	8323	<>		345	<p>12 12 3/8" x 24 fil.</p> <p><b>FB18</b>    <b>MP15</b></p>	7701454063
----------	-------------	------	----	--	-----	---	------------

### R17

1.6	03/72-07/77	8323	<>		345	<p>12 12 3/8" x 24 fil.</p> <p><b>FB18</b>    <b>MP15</b></p>	7701454063
1.6	03/72-07/77	8324	<>		325	<p>9.5 13 3/8" x 24 fil.</p> <p><b>FB19</b>    <b>MP16</b></p>	7701452077

### R18

#### 1.4, 1.6 GTL

TT	04/78-82	8332	<>		320	<p>9 10x1 10x1</p> <p><b>FB23</b>    <b>MP21</b></p>	7701349111
TT	82-86	8390	<>		405	<p>9 13 10x1 10x1</p> <p><b>FB23</b>    <b>MC11</b></p>	7701349336
TT	04/78-86	8392	<>		315	<p>9 13 10x1 10x1</p> <p><b>FB23</b>    <b>MC11</b></p>	7701349337

#### 1.6 GTS



TT	-86	8389	<>		290	<p>9 13 10x1 10x1</p> <p><b>FB23</b>    <b>MC11</b></p>	7701349127
TT	-86	8392	<>		315	<p>9 13 10x1 10x1</p> <p><b>FB23</b>    <b>MC11</b></p>	7701349337

Legenda/Legend: ○ = Intermedio/Intermediate - ● = Interno/Inner - ▲ = Superiore/Upper - ▼ = Inferiore/Lower

**TUBI FLESSIBILI PER FRENO**

**L**

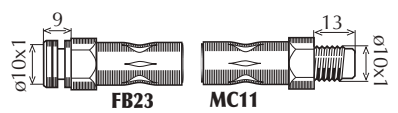
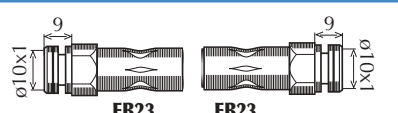
**o.e.**
**segue R18**
**2.0 Berlina**

TT	04/78-86	<b>8390</b>	<>		290	 <b>FB23</b> <b>MC11</b>	7701349336
TT	04/78-86	<b>8391</b>		▼	370	 <b>FB23</b> <b>FB23</b>	7701349338
TT	04/78-86	<b>8392</b>		▲	315	 <b>FB23</b> <b>MC11</b>	7701349337

**2.0 SW**

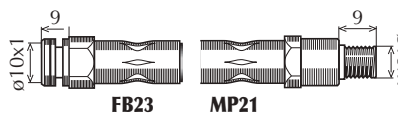
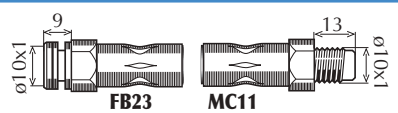
TT	04/78-86	<b>8332</b>	<>		320	 <b>FB23</b> <b>MP21</b>	7701349111
TT	04/78-86	<b>8392</b>		<>	315	 <b>FB23</b> <b>MC11</b>	7701349337

**2.1 D-TD**

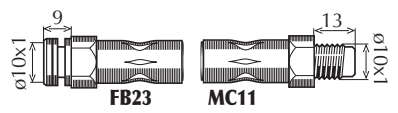
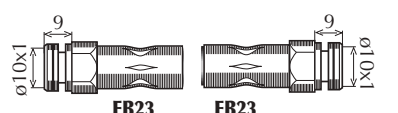
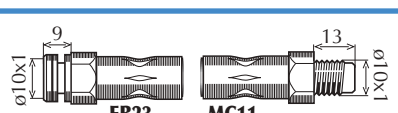
TT	04/78-86	<b>8390</b>	<>		290	 <b>FB23</b> <b>MC11</b>	7701349336
TT	04/78-86	<b>8391</b>		▼	370	 <b>FB23</b> <b>FB23</b>	7701349338
TT	04/78-86	<b>8392</b>		▲	315	 <b>FB23</b> <b>MC11</b>	7701349337

**R19**

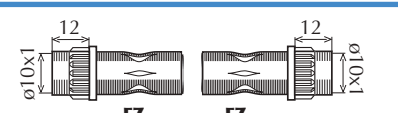
TT	89-12/95	<b>8494</b>	<>		290	 <b>FZ</b> <b>MC11</b>	7704003958
TT (- ABS) (Tamburo Post)	89-12/95	<b>8501</b>		<>	270	 <b>FZ</b> <b>FZ</b>	7704003549

## TUBI FLESSIBILI PER FRENO



L



o.e.

### segue R19

TT (- ABS) (Disco Post)	89-12/95	<b>8495</b>	<>	280		7704003961
TT (+ ABS)	-92	<b>8637</b>	<>	190		7700416273
TT (+ ABS)	92-12/95	<b>8635</b>	<>	245		7704001951

### R20

TT	77-83	<b>8390</b>	<>	405		7701349336
TT	77-83	<b>8404</b>	<>	250		7701348207

### R21

#### 1.7, 1.9 D

TT	86-95	<b>8496</b>	<>	270		7704003887
TT (- ABS)	86-95	<b>8444</b>	<>	305		7704003905
TT (+ ABS)	86-95	<b>8497</b>	<>	350		7704003955

#### 1.7, 1.9 D NEVADA

TT	86-95	<b>8496</b>	<>	270		7704003887
TT (- ABS)	86-95	<b>8635</b>	<>	245		7704001951

Legenda/Legend: ○ = Intermedio/Intermediate - ● = Interno/Inner - ▲ = Superiore/Upper - ▼ = Inferiore/Lower

**TUBI FLESSIBILI PER FRENO**

**o.e.**
**segue R21**
**segue 1.7, 1.9 D NEVADA**

TT (+ ABS)	86-95	<b>8494</b>	<>	290		7704003958
------------	-------	-------------	----	-----	--	------------

**2.0, 2.1 D-TD**

TT	86-95	<b>8497</b>	<>	350		7704003955
----	-------	-------------	----	-----	--	------------

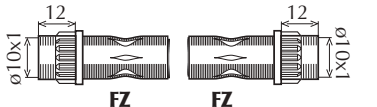
TT (- ABS)	86-95	<b>8444</b>	<>	305		7704003905
------------	-------	-------------	----	-----	--	------------

TT (+ ABS)	86-95	<b>8640</b>	<>	310		7700832611
------------	-------	-------------	----	-----	---	------------

**2.0, 2.1 D-TD NEVADA**

TT	86-95	<b>8497</b>	<>	350		7704003955
----	-------	-------------	----	-----	--	------------

TT (- ABS)	86-95	<b>8635</b>	<>	245		7704001951
------------	-------	-------------	----	-----	--	------------

TT (+ ABS)	86-95	<b>8494</b>	<>	290		7704003958
------------	-------	-------------	----	-----	--	------------

**R25**

TT	84-93	<b>8641</b>	<>	430		7701204831
----	-------	-------------	----	-----	--	------------

TT	84-93	<b>8501</b>	<>	270		7704003549
----	-------	-------------	----	-----	--	------------

TT (+ ABS) (alla pinza)	84-93	<b>8632</b>	<>	180		7704002443
-------------------------	-------	-------------	----	-----	--	------------



## TUBI FLESSIBILI PER FRENO



L



o.e.

### SAFRANE I

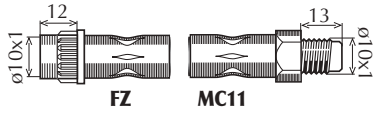
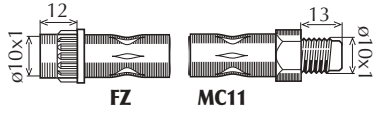
TT	05/92->0796	8638	<>		315		7701204590
TT (+ ABS)	05/92->0796	8639	<>		410		7700811705
3.0 V6 4x4	05/92->0796	8443	<>		330		7704003913

### SAFRANE II

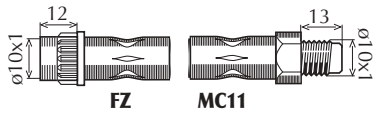
TT	08/96-12/96	8638	<>		315		7701204590
TT	08/96-12/96	8639	<>		410		7700811705

### TWINGO I

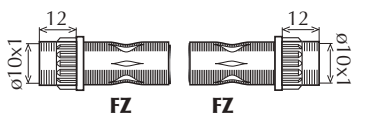
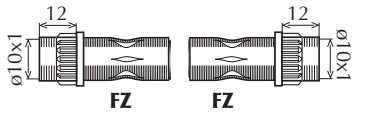
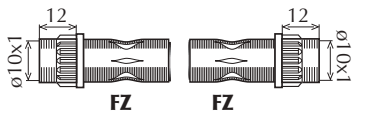
TT	03/93-	8497	<>		350		7704003955
TT	03/93-04/96	8501	<>		270		7704003549
TT (- ABS)	05/96-	80747	<>		210		7704003957
TT (+ ABS)	03/93-	8576	<>		235		7700834990

### TWINGO II

TT	03/07-	8636	<>		345		7700423975
----	--------	------	----	--	-----	--	------------

**TUBI FLESSIBILI PER FRENO**

**L**

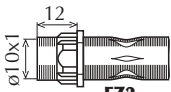

**o.e.**
**segue TWINGO II**

TT	03/07-	<b>8637</b>	<>		190	 	7700416273
----	--------	-------------	----	--	-----	--	------------

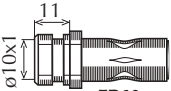
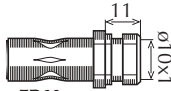
**VELSATIS**

TT	06/02-	<b>80009</b>	<>		410	 	7701050070
----	--------	--------------	----	--	-----	--	------------

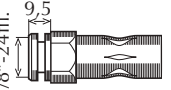
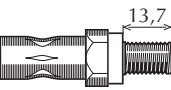
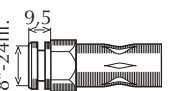
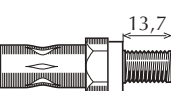
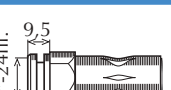

**RENAULT COMMERCIALI**
**R4 Furgonette**

TT	-07/82	<b>8096</b>	<>		500	 	7701454835
TT	08/82-	<b>8309</b>	<>		460	 	7701348800
TT		<b>8097</b>	<>		270	 	7704001957

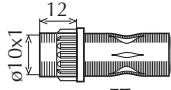
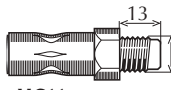
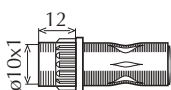
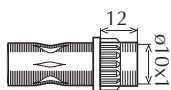
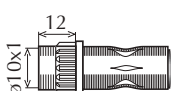
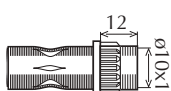
**EXPRESS**

TT	86-	<b>8443</b>	<>		330	 	7704003913
TT (- Carico maggiorato)	86-	<b>8501</b>	<>		270	 	7704003549
TT Carico maggiorato	86-	<b>8444</b>	<>		305	 	7704003905

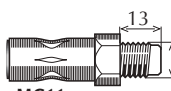
**MASTER**

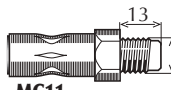
2.0, 2.4 D, 2.5 D, 2.5 TD (T28-T30-T35)	80-98	<b>8946</b>	<>		500	 	5000388495
2.0, 2.4 D, 2.5 D, 2.5 TD (T28-T30-T35)	80-98	<b>8947</b>	<>		345	 	5000388496

## TUBI FLESSIBILI PER FRENO



L



o.e.

### MASTER II-III

TT	09/03-08/06	<b>80206</b>	<>		582		5010422007
TT (Tamburo Post.) (Inferiore)	07/98-08/03	<b>80385</b>	<>		615		7700302379
TT (Tamburo Post.) (Superiore)	07/98-08/03	<b>80384</b>	<>		570		7700302380
TT (Disco Post.) (Inferiore)	07/98-08/03	<b>80587</b>			535		8200057462
TT (Disco Post.) (Superiore)	07/98-08/03	<b>80588</b>			510		8200057460
TT (centrale)	07/98-08/06	<b>80208</b>		○	433		7700309823
TT (Maxi)	07/98-08/06	<b>80207</b>	<>		270		5010422009
TT (Disco Post.)	07/98-08/06	<b>80211</b>	<>		355		8200086894

### MASTER IV

TT	02/10-	<b>81004</b>	<>		405		8200735345
TT	02/10-	<b>81005</b>	<>		620		8200735348

Legenda/Legend: ○ = Intermedio/Intermediate - ● = Interno/Inner - ▲ = Superiore/Upper - ▼ = Inferiore/Lower

## TUBI FLESSIBILI PER FRENO





L



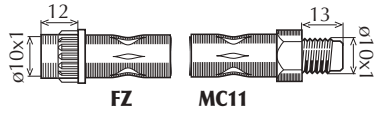
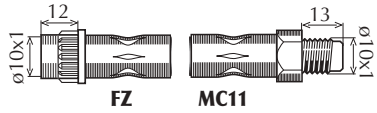

o.e.

### TRAFIC

TT (Serie P)	80-	<b>8497</b>	<>		350	 <p>FZ MC11</p>	7704003955
TT (Serie T)	80-	<b>8498</b>	<>		345	 <p>FZ MC11</p>	7704001953
TT	80-	<b>8499</b>	<>		410	 <p>FZ MC11</p>	7704001955

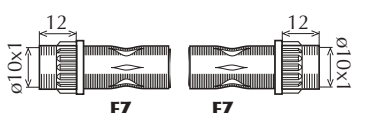
### TRAFIC II

TT	03/01	<b>80200</b>	<>		415	 <p>FZ MC11</p>	8200003478
TT	03/01	<b>80201</b>	<>		230	 <p>FZ FZ</p>	8200003480
TT (alla pinza)	08/01-	<b>80252</b>	<>		250	 <p>FZ MC11</p>	8200003481

## TUBI FLESSIBILI PER FRENO



L



o.e.

### MAESTRO

TT	83-93	8474	<>		325	<p>MC11 MC22</p>	GBH192
----	-------	------	----	--	-----	------------------	--------

### METRO

TT	80-90	8396	<>		300	<p>MC11 MC22</p>	GBH246
TT	80-90	8472		>	205	<p>MC22 MC22</p>	GBH247
TT	80-90	8473		<	195	<p>MC11 MC22</p>	GBH248

### MINI

TT	69-	8145	<>		330	<p>MF6 MP6</p>	
TT	69-	8131		>>	208	<p>MC4 MC4</p>	

### MONTEGO

TT	84-95	8474	<>		325	<p>MC11 MC22</p>	GBH192
TT	84-95	8475		<>	254	<p>FB3 FB3</p>	GBH193

### Serie 100

TT	09/90-12/98	8948	>			<p>Il disegno non è disponibile The drawing is not available</p>	GBH254
TT	09/90-12/98	8949	<			<p>Il disegno non è disponibile The drawing is not available</p>	GBH255

## TUBI FLESSIBILI PER FRENO



### Serie 100



TT	09/90-12/98	8472	<>	205	 MC22 MC22	GBH247
----	-------------	------	----	-----	---	--------

### Serie 200

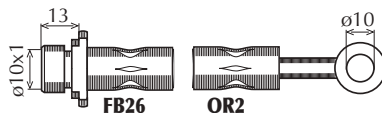
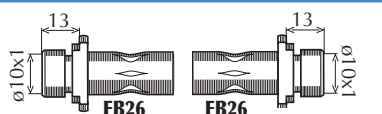

#### 213, 216 (84->90)

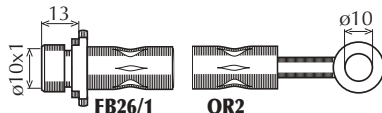
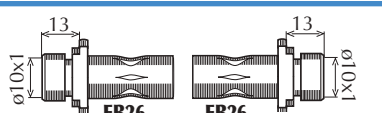
213, 216	84-90	8476	<>	480	 FB26 OR2	GBH245
213, 216	84-90	8477	<>	240	 FB26 FB26	GBH244

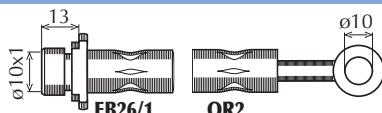

#### 214, 216, 218 D, 218 TD (90->10/95)

TT	90-10/95	8478	<>	505	 FB26/1 OR2	GBH251
TT (- ABS)	90-10/95	8477	<>	240	 FB26 FB26	GBH244
TT (+ ABS)	90-10/95	8480	<>	486	 F MC11	GBH253

#### 211, 214, 216, 218, 220 D, 220 SDI (11/95->03/00)

TT	11/95-03/00	8069	<>	500	 FB26/1 OR2	GBH90283
TT	11/95-03/00	8070	<>	290	 FB26/1 FB26/1	GBH90288

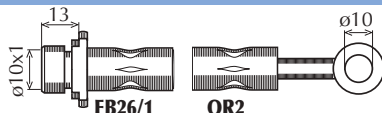
#### 25 1.4, 1.6, 1.8, 2.0 D (10/99->)

TT	10/99-	8069	<>	500	 FB26/1 OR2	GBH90283
TT	10/99-	8070	<>	290	 FB26/1 FB26/1	GBH90288

## TUBI FLESSIBILI PER FRENO



**o.e.**

### segue Serie 200

#### segue 25 1.4, 1.6, 1.8, 2.0 D (10/99->)

TT (+ ABS)	10/99-	<b>80339</b>	<>	645		GBH90289
------------	--------	--------------	----	-----	--	----------

### Serie 400

#### 414, 416, 420, 418 D, 418 TD (90->10/95)

TT	90-10/95	<b>8478</b>	<>	505		GBH251
TT (- ABS)	90-10/95	<b>8477</b>	<>	240		GBH244
TT (+ ABS)	90-10/95	<b>8480</b>	<>	486		GBH253

#### 414, 416, 420, 420 D (11/95->03/00)

TT	11/95-03/00	<b>8093</b>	>	685		GBH90286
TT	11/95-03/00	<b>8094</b>	<	685		GBH90337
TT	11/95-03/00	<b>8078</b>	<>	248		GBH90299
TT (+ ABS)	11/95-03/00	<b>80274</b>	<>	575		GBH90287

#### 45 1.4, 1.6, 1.8, 2.0, 2.0 D (03/00->)

TT	03/00-	<b>8093</b>	>	685		GBH90286
TT	03/00-	<b>8094</b>	<	685		GBH90337

Legenda/Legend: ○ = Intermedio/Intermediate - ● = Interno/Inner - ▲ = Superiore/Upper - ▼ = Inferiore/Lower

## TUBI FLESSIBILI PER FRENO



L



o.e.

### segue Serie 400

segue 45 1.4, 1.6, 1.8, 2.0, 2.0 D (03/00->)

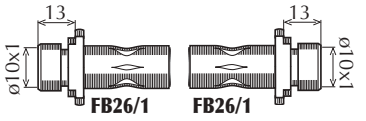
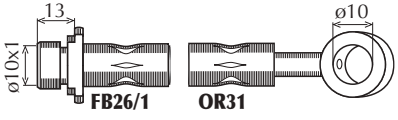
TT	03/00-	8078	<>	248		GBH90299
TT (+ ABS)	03/00-	80274	<>	575		GBH90287

### Serie 600

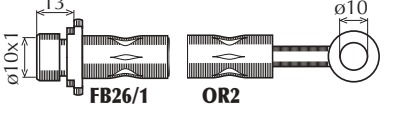
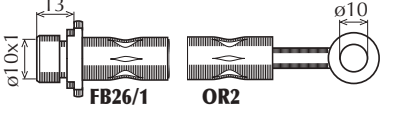
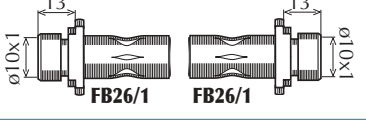
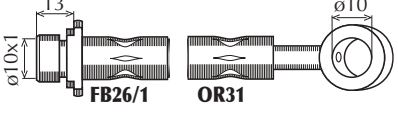
TT	08/93-	80337	>	700		GBH90264
TT	08/93-	80332	<	700		GBH90277
TT (centrale)	08/93-	80313	○	380		GBH90265
TT	08/93-	80291	<>	225		GBH90266

### 75

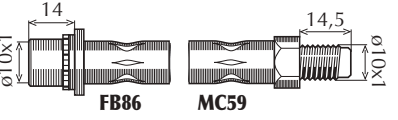
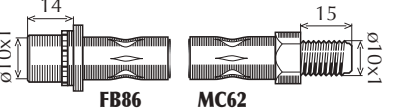
TT	02/99-	80595	<>	550		GBH 90336
TT	02/99-	80596	<>	560		GBH 90335



## TUBI FLESSIBILI PER FRENO



L



o.e.

### 90

2.0	09/84-08/87	8224	<>		265	<p>MC11 MC22</p>	8931792
2.0	09/84-08/87	8225	<>		270	<p>MC22 MC22</p>	8931784

### 99

2.0	09/75-01/87	8224	<>		265	<p>MC11 MC22</p>	8931792
2.0	09/75-01/87	8225	<>		270	<p>MC22 MC22</p>	8931784

### 900 I

TT	11/80-01/89	8224	<>		265	<p>MC11 MC22</p>	8931792
TT	01/89-12/93	8545	<>		310	<p>FB3/1 OR1</p>	4241444
TT	11/80-12/93	8225	<>		270	<p>MC22 MC22</p>	8931784

### 900 II

TT	12/93-	8545	<>		310	<p>FB3/1 OR1</p>	4241444
TT	12/93-	8614	>		235	<p>FB3/1 MC43</p>	4483285
TT	12/93-	80597	<		245	<p>FB3/1 MC43</p>	4482337

Legenda/Legend: ○ = Intermedio/Intermediate - ● = Interno/Inner - ▲ = Superiore/Upper - ▼ = Inferiore/Lower

**TUBI FLESSIBILI PER FRENO**

**L**

**o.e.**
**9-3 (YS3D)**

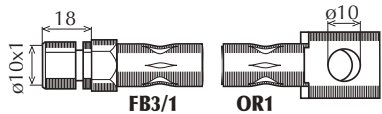
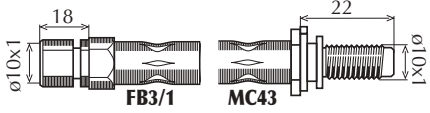
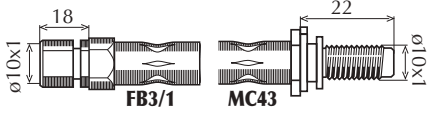
TT	02/98-09/02	<b>8545</b>	<>		310		4241444
TT	02/98-09/02	<b>8614</b>		▼	235		4483285
TT	02/98-09/02	<b>80597</b>		▲	245		4482337

**9-3 (YS3F)**

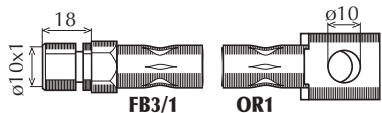
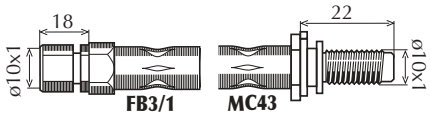
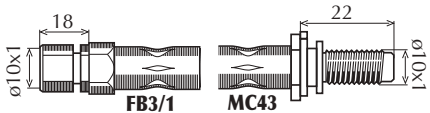
TT	09/02-	<b>8545</b>	<>		310		4241444
TT	09/02-	<b>8614</b>		▼	235		4483285
TT	09/02-	<b>80597</b>		▲	245		4482337

**9-3 Sport (Mod.2007)**

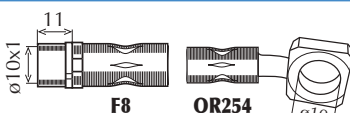
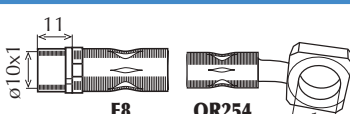
TT	01/07-	<b>80340</b>	<>		425		51759919
TT	01/07-	<b>80849</b>		▲	315		12841242
TT	01/07-	<b>80850</b>		▼	315		12841243

**9000**

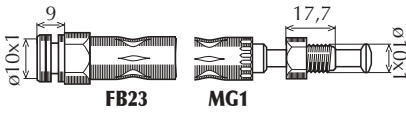
TT	09/89-12/98	<b>8098</b>	<>		555		4426474
----	-------------	-------------	----	--	-----	--	---------

## TUBI FLESSIBILI PER FRENO



L



o.e.

### segue 9000

TT	09/89-12/98	8099	<>	375	<p>FB23 MC1</p>	4837076
<b>9-5</b>						
TT	09/97-	80598	<>	445	<p>FB3/1 OR7</p>	4565743
TT	09/97-	8541	<>	195	<p>FB3/1 FB3/1</p>	4565719
TT (alla pinza)	09/97-	80599	<>	205	<p>F8 MC11</p>	4908695

## TUBI FLESSIBILI PER FRENO



L



o.e.

### ALHAMBRA

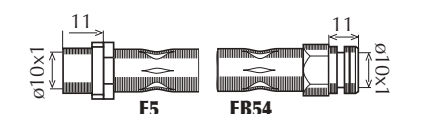
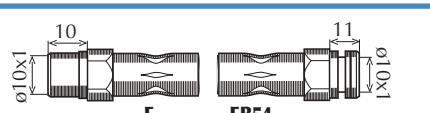
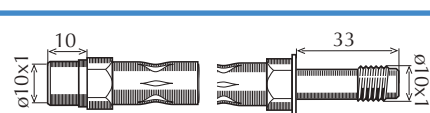
TT	04/96-03/00	8924	<>		500		7M0611701D
TT	04/00-	80258	<>		480		7M3611701B
TT	04/96-	80244	<>		400		7M0611775E
TT (alla pinza)	04/96-	8925	<>		185		7M0611776B/C

### ALTEA (5P1)

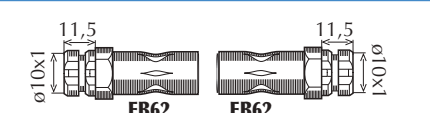
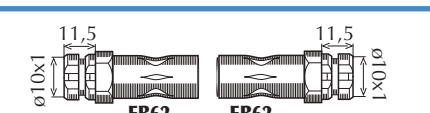
TT	03/04-	80160	<>		595		1K0611701B
TT		81020	<>		525		1K0611701L
TT	03/04-	80161	<>		257		1K0611775C

### ALTEA XL (5P5)

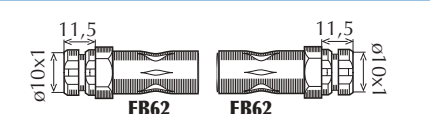
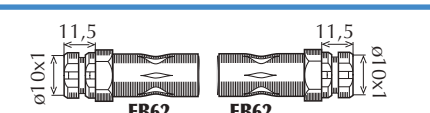
TT	10/06-	80160	<>		595		1K0611701B
TT		81020	<>		525		1K0611701L
TT	10/06-	80161	<>		257		1K0611775C

## TUBI FLESSIBILI PER FRENO

**L**

**o.e.**

### AROSA

1.0,1.4,1.4 TDI,1.7 SDI	97-	<b>8966</b>	<>	410	<p><b>F7</b>      <b>OR22</b></p>	6N0611701/A/B
1.0,1.4,1.4 TDI,1.7 SDI	97-	<b>8903</b>	<>	165	<p><b>FB49</b>      <b>FB49</b></p>	6X0611775

### CORDOBA (6K2/C2)

TT	02/93-06/99	<b>8551</b>	<>	485	<p><b>F</b>      <b>MCL</b></p>	1H0611701
TT	02/93-06/99	<b>8643</b>	<>	160	<p><b>FB23</b>      <b>FB23</b></p>	1H0611775
1.8 16V, 2.0, 1.9 TDI (alla pinza)	02/93-06/99	<b>8036</b>	<>	187	<p><b>F</b>      <b>MC11</b></p>	481611775

### CORDOBA (6K2) Vario (6K5)

TT	06/99-10/02	<b>8551</b>	<>	485	<p><b>F</b>      <b>MCL</b></p>	1H0611701
TT	06/99-10/02	<b>8903</b>	<>	165	<p><b>FB49</b>      <b>FB49</b></p>	6X0611775

### CORDOBA (6L2)

TT	10/02-	<b>80008</b>	<>	555	<p><b>FB62</b>      <b>OR22</b></p>	6Q0611701C
TT	10/02-	<b>8903</b>	<>	165	<p><b>FB49</b>      <b>FB49</b></p>	6X0611775

## TUBI FLESSIBILI PER FRENO



L



o.e.

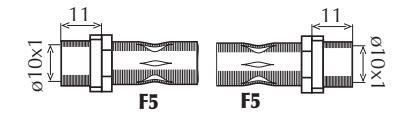
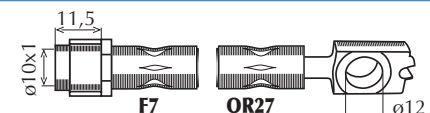

### EXEO

TT	12/08-	80171	<>		328		8E0611707G
TT	12/08-	80254	<>		280		8E0611775N

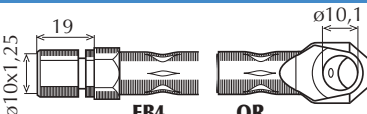
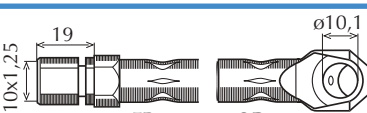

### FURA

TT	82-86	8266	<>		300		4348052
TT	82-86	8269	<>		265		4257052

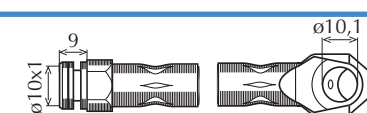
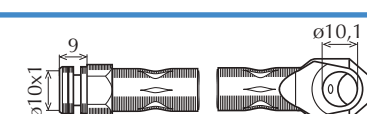
### IBIZA I (021A)

TT	06/84-04/85	8512	<>		435		SE022744400A
TT	05/85-2/93	8355	<>		421		SE022744400C
TT	06/84-04/85	8513	<>		305		SE021744400A
TT	05/85-2/93	8510	<>		280		SE022744400B

### IBIZA II-III (6K1)

TT	03/93-02/02	8551	<>		485		1H0611701
TT	03/93-08/99	8643	<>		160		1H0611775

## TUBI FLESSIBILI PER FRENO

**L**

**o.e.**

### segue IBIZA II-III (6K1)

1.8 16V, 2.0, 1.9 TDI (alla pinza)	03/93-08/99	<b>8036</b>	<>	187	<p><b>F</b>      <b>MC11</b></p>	481611775
TT	09/99->02/02	<b>8903</b>	<>	165	<p><b>FB49</b>      <b>FB49</b></p>	6X0611775

### IBIZA IV (6L1)

TT	02/02-	<b>80008</b>	<>	555	<p><b>FB62</b>      <b>OR22</b></p>	6Q0611701C
TT	02/02-	<b>8903</b>	<>	165	<p><b>FB49</b>      <b>FB49</b></p>	6X0611775

### IBIZA V (6J5)

TT	03/08-06/10	<b>80851</b>	<>	565	<p><b>FB62</b>      <b>OR22</b></p>	6R0611701A
TT	06/10-	<b>80948</b>	<>	555	<p><b>FB62</b>      <b>OR22</b></p>	6R0611701B
TT	03/08-	<b>8903</b>	<>	165	<p><b>FB49</b>      <b>FB49</b></p>	6Q0611775B

### LEON I (1M1)

TT	10/99-	<b>8616</b>	<>	435	<p><b>FB49</b>      <b>OR22</b></p>	1J0611701
TT	10/99-	<b>8903</b>	<>	165	<p><b>FB49</b>      <b>FB49</b></p>	6X0611775
TT (alla pinza)	10/99-	<b>80623</b>	>			1J0611764K

## TUBI FLESSIBILI PER FRENO



L





o.e.



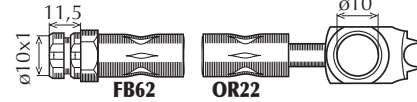
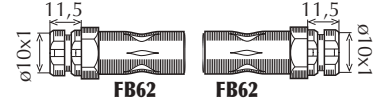
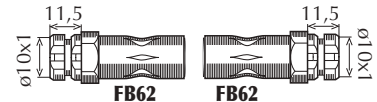

### segue LEON I (1M1)

TT (alla pinza)	10/99-	<b>80622</b>	<				1J0611763K
-----------------	--------	--------------	---	--	--	--	------------

### LEON II (1P1)

TT	09/05-	<b>80160</b>	<>		595		1K0611701B
TT		<b>81020</b>	<>		525		1K0611701L
TT	09/05-10/09	<b>80161</b>	<>		257		1K0611775C
TT	11/09-	<b>80852</b>	<>		270		1K0611775D

### MALAGA

TT	11/84-04/85	<b>8512</b>	<>		435		SE022744400A
TT	05/85-12/93	<b>8355</b>	<>		421		SE022744400C
TT	11/84-04/85	<b>8513</b>	<>		305		SE021744400A
TT	05/85-12/93	<b>8510</b>	<>		280		SE022744400B

### MARBELLA

TT	08/86-	<b>8353</b>	<>		463		SE141744400B
----	--------	-------------	----	--	-----	--	--------------



## TUBI FLESSIBILI PER FRENO



L



o.e.

### segue MARBELLA

TT	08/86-90	8354	<>	284		SE141744400D
TT	90-	8642	<>	285		SE028744400A

### Mii

TT	10/11-	81058	<>	525		1S0611701
TT	10/11-	81059	<>	175		1S0611775

### RONDA

TT	83-12/86	8512	<>	435		SE022744400A
TT	83-12/86	8510	<>	280		SE022744400B

### TOLEDO I (1L)

1.6, 1.8, 1.9 D, 1.9 TD, 1.9 TDI	91-03/99	8644	<>	360		1L0611701
1.8 16V, 2.0, 2.0 16V	91-03/99	80247	<>	315		191611701A
TT	91-03/99	8229	<>	160		481611776

### TOLEDO II (1M2)

TT	04/99-	8616	<>	435		1J0611701
----	--------	------	----	-----	--	-----------

Legenda/Legend: ○ = Intermedio/Intermediate - ● = Interno/Inner - ▲ = Superiore/Upper - ▼ = Inferiore/Lower

## TUBI FLESSIBILI PER FRENO





L

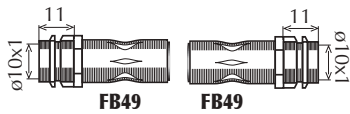

o.e.

### segue TOLEDO II (1M2)

TT	04/99-	8903	<>	165		6X0611775
TT (alla pinza)	04/99-	80623	>			1J0611764K
TT (alla pinza)	04/99-	80622	<			1J0611763K

### TOLEDO III (5P2)

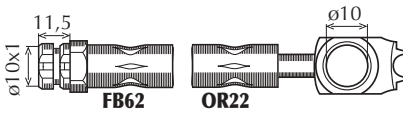
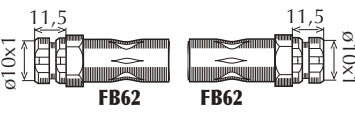
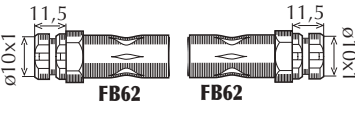
TT	10/04-	80160	<>	595		1K0611701B
TT		81020	<>	525		1K0611701L
TT	10/04-	80161	<>	257		1K0611775C

### SEAT COMMERCIALI INCA

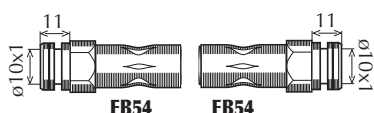
TT	11/95-	8551	<>	485		1H0611701
TT	11/95-	8969	<>	430		6K9611776

### TERRA

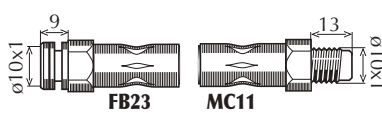
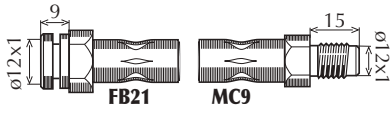
TT	08/86-12/96	8353	<>	463		SE141744400B
TT	08/86-12/96	8642	<>	285		SE028744400A

## TUBI FLESSIBILI PER FRENO



L



o.e.

### 105/120/130/136

TT	84-90	<b>8008</b>	<>		495		114595613
TT	84-90	<b>8009</b>	<>		440		114595611

### FABIA (6Y\_)

TT	12/99-03/08	<b>80008</b>	<>		555		6Q0611701C
TT	12/99-03/08	<b>8903</b>	<>		165		6X0611775

### FABIA (Mod 2007)

TT	03/07-	<b>80008</b>	<>		555		6Q0611701C
TT	03/07-	<b>8903</b>	<>		165		6X0611775

### FAVORIT

1.3 (Berlina, Pick Up, SW)	05/89-06/97	<b>8010</b>	<>		380		115595612
1.3 (Berlina, Pick Up, SW)	05/89-06/97	<b>8333</b>	<>		260		115595621



### FELICIA I-II (6U1-6U5)

TT	10/94-	<b>80256</b>	<>		370		6U0611701A
TT	10/94-	<b>8991</b>	<>		195		005312587

# TUBI FLESSIBILI PER FRENO

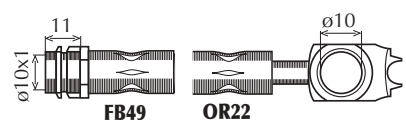
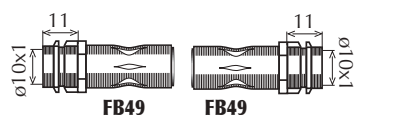

## OCTAVIA I (1U2-1U5)

TT	09/96-	<b>8616</b>	<>		435		1J0611701
TT	09/96-	<b>8903</b>	<>		165		6X0611775
TT (alla pinza)	09/96-	<b>80623</b>		▼			1J0611764K
TT (alla pinza)	09/96-	<b>80622</b>		▲			1J0611763K

## OCTAVIA II (1Z3-1Z5)

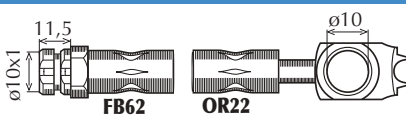
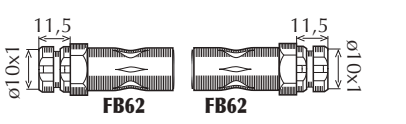
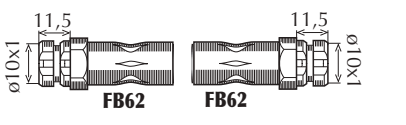
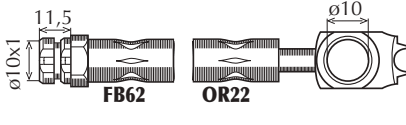
TT	06/04-	<b>80160</b>	<>		595		1K0611701B
TT		<b>81020</b>	<>		525		1K0611701L
TT	06/04-10/09	<b>80161</b>	<>		257		1K0611775C
TT	10/08-	<b>80852</b>	<>		270		1K0611775D

## ROOMSTER (5J)

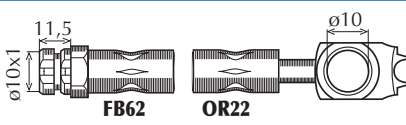
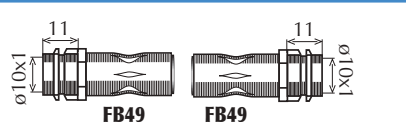
TT	09/06-	<b>80008</b>	<>		555		6Q0611701C
TT	09/06-	<b>8903</b>	<>		165		6X0611775

## TUBI FLESSIBILI PER FRENO



L



o.e.

### SUPERB I (3U4)

TT	02/02-03/08	<b>8035</b>	<>		310		8D0611707
TT	02/02-03/08	<b>8061</b>	<>		205		8D0611775E

### SUPERB II (3T4)

TT	03/08-	<b>80160</b>	<>		595		1K0611701M
TT		<b>81020</b>	<>		525		1K0611701L
TT	03/08-10/09	<b>80161</b>	<>		257		1K0611775C
TT	11/09-	<b>80852</b>	<>		270		1K0611775D

### YETI

TT	03/08-	<b>80160</b>	<>		595		1K0611701M
TT		<b>81020</b>	<>		525		1K0611701L
TT	03/08-10/09	<b>80892</b>	<>		265		1Q0611775A
TT	11/09-	<b>80852</b>	<>		270		1K0611775D

**TUBI FLESSIBILI PER FRENO**

**L**

**o.e.**
**SKODA COMMERCIALI  
RAPID**

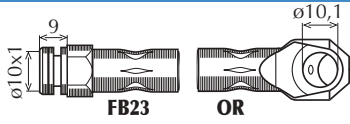
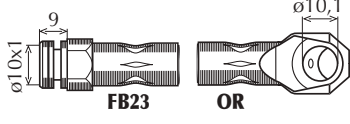
TT	84-90	<b>8008</b>	< >		495		114595613
TT	84-90	<b>8009</b>	< >		440		114595611

## TUBI FLESSIBILI PER FRENO



L



o.e.

### FORESTER (SF)

TT	08/97-09/02	<b>80398</b>	▼		555		26550FC010
TT	08/97-09/02	<b>80376</b>	▲		560		26550FC020
TT (centrale)	08/97-09/02	<b>80378</b>		○	360		26550FC000
TT	08/97-09/02	<b>80380</b>	▼		545		26550FC030
TT	08/97-09/02	<b>80377</b>	▲		545		26550FC040

### FORESTER (SG)

TT	09/02-	<b>80380</b>	▼		545		26550FC030
TT	09/02-	<b>80377</b>	▲		545		26550FC040

### FORESTER (SH)

TT	01/08-	<b>80865</b>	▲		570		26590SC010
TT	01/08-	<b>80866</b>	▼		570		26590SC000
TT	01/08-	<b>80867</b>	▲		515		26591SC010

Legenda/Legend: ○ = Intermedio/Intermediate - ● = Interno/Inner - ▲ = Superiore/Upper - ▼ = Inferiore/Lower

## TUBI FLESSIBILI PER FRENO



L



o.e.

### segue FORESTER (SH)

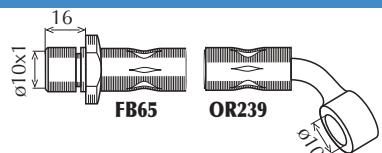
TT	01/08-	<b>80868</b>	▼	515		26591SC000
----	--------	--------------	---	-----	--	------------

### IMPREZA (GF)

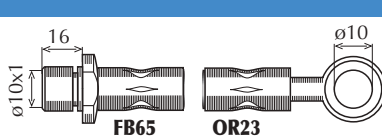
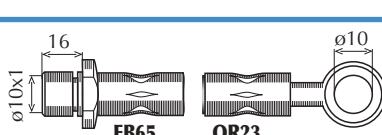
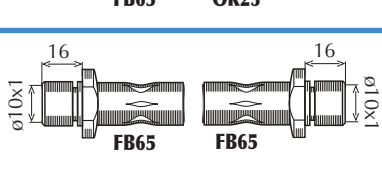
TT	08/92-12/00	<b>80110</b>	▼	519		26531AA001
TT	08/92-12/00	<b>80111</b>	▲	520		26531AA010
TT	08/92-12/00	<b>80112</b>	◀▶	337		26531AA020

### IMPREZA (GD)

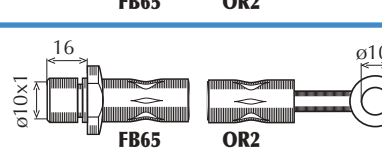
TT	12/00-	<b>80383</b>	▼	515		26540AE000
TT	12/00-	<b>80379</b>	▲	515		26540AE020

### IMPREZA (GR)

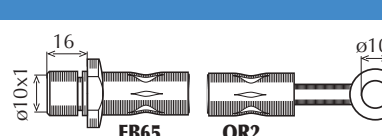
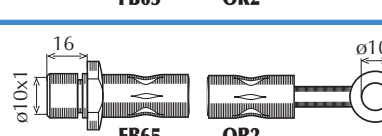
TT	01/08-	<b>80383</b>	▼	515		26590AE001
TT	01/08-	<b>80379</b>	▲	515		26590AE020
TT	01/08-	<b>80857</b>	▼		Il disegno non è disponibile The drawing is not available	26541FG000
TT	01/08-	<b>80856</b>	▲		Il disegno non è disponibile The drawing is not available	26541FG010



## TUBI FLESSIBILI PER FRENO



L



o.e.

### JUSTY I (KAD)

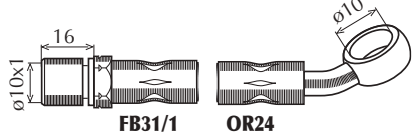
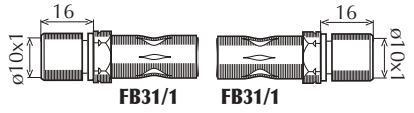
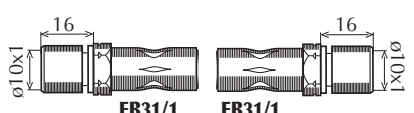
TT (interno)	07/88-10/95	<b>8111</b>	<>		220		725531400
TT	07/88-10/95	<b>8107</b>	<>		265		725531080
TT	07/88-10/95	<b>8107</b>	<>	<>	265		725531210

### JUSTY II (JMA, MS)

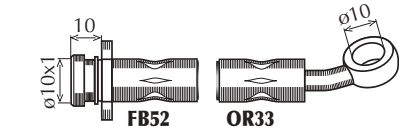
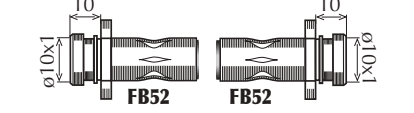
1.3 4x4	10/95-11/03	<b>80108</b>	<>		475		5158063B00
1.3 4x4	10/95-11/03	<b>80109</b>	<>	<>	421		5159063B00

### JUSTY III (G3X)

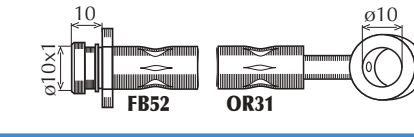
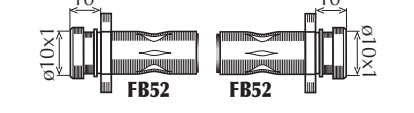
TT	09//03-	<b>8932</b>	<>		440		5155083E00
TT	09//03-	<b>80270</b>	<>	<>	307		5157083E00

### JUSTY IV

TT	01/07-	<b>80862</b>	<			Il disegno non è disponibile The drawing is not available	9004922192
TT	01/07-	<b>80863</b>	>			Il disegno non è disponibile The drawing is not available	9004922191
TT	01/07-	<b>80864</b>	<>	<>		Il disegno non è disponibile The drawing is not available	9004922193

## TUBI FLESSIBILI PER FRENO







L





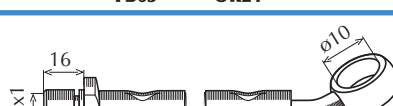

o.e.

### LEGACY I (BC) SW (BJF)

TT	08/89-07/94	<b>80110</b>	▼		519		26531AA001
TT	08/89-07/94	<b>80111</b>	▲		520		26531AA010
1800, 2000 (tamburo)	08/89-07/94	<b>80112</b>		◀▶	337		26531AA020
TT (disco)	08/89-07/94	<b>80113</b>	▼		520		26531AA041
TT (disco)	08/89-07/94	<b>80114</b>	▲		523		26531AA070

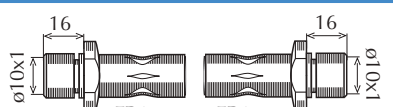
### LEGACY II (BD-BG)

TT	09/94-03/99	<b>80110</b>	▼		519		26531AA001
TT	09/94-03/99	<b>80111</b>	▲		520		26531AA010
1800, 2000 (tamburo)	09/94-03/99	<b>80112</b>		◀▶	337		26531AA020
TT (disco)	09/94-03/99	<b>80113</b>	▼		520		26531AA041
TT (disco)	09/94-03/99	<b>80114</b>	▲		523		26531AA070

## TUBI FLESSIBILI PER FRENO



**o.e.**

### LEGACY III (BE-BH)

TT	10/98-08/03	<b>80383</b>	▼		515		26540AE000
TT	10/98-08/03	<b>80379</b>	▲		515		26540AE020
TT	10/98-08/03	<b>80600</b>	▼		300		26541AE020
TT	10/98-08/03	<b>80382</b>	▲		270		26541AE010

### LEGACY IV

TT	09/03-	<b>80383</b>	▼		515		26540AE000
TT	09/03-	<b>80379</b>	▲		515		26540AE020
TT	09/03-	<b>80382</b>	▲▼		270		26541AE010

### LEGACY V

TT	09/09-	<b>80858</b>	▲		555		26590AJ050
TT	09/09-	<b>80859</b>	▼		555		26590AJ040
TT	09/09-	<b>80860</b>	▲		520		26591AJ070
TT	09/09-	<b>80861</b>	▼		520		26591AJ060

Legenda/Legend: ○ = Intermedio/Intermediate - ● = Interno/Inner - ▲ = Superiore/Upper - ▼ = Inferiore/Lower

## TUBI FLESSIBILI PER FRENO



L



o.e.

### LEONE

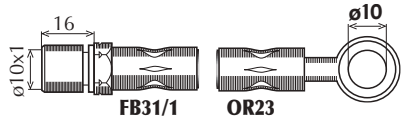
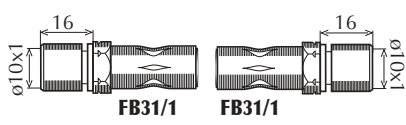
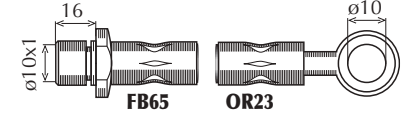
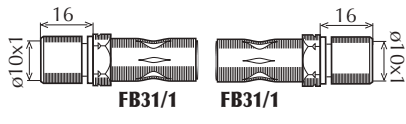
TT	03/79-12/87	8522	<>		470		799925000
TT	03/79-12/87	8523	<>		140		725531020
1.8 SW 4WD	12/86-07/91	80115	>		481		25531GA300
1.8 SW 4WD	12/86-07/91	80116	<>		204		25531GA140

### OUTBACK (BE-BH)

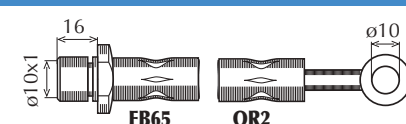
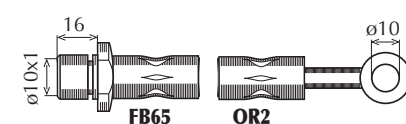
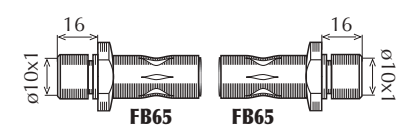
TT	10/00-08/03	80383	>		515		26540AE000
TT	10/00-08/03	80379	<		515		26540AE020
TT	10/00-08/03	80382	<>		270		26541AE010

### OUTBACK (Mod.2003)

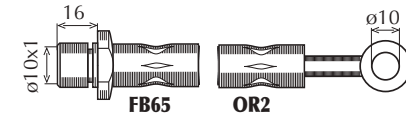
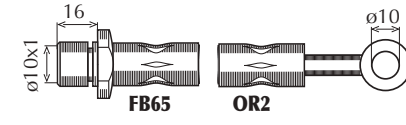
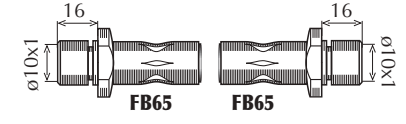
TT	09/03-	80383	>		515		26540AE000
TT	09/03-	80379	<		515		26540AE020
TT	09/03-	80382	<>		270		26541AE010

## TUBI FLESSIBILI PER FRENO



L



o.e.

### TRIBECA

TT	09/09-	<b>80869</b>	◁		585		26540XA01A9E
TT	09/09-	<b>80870</b>	▷		585		26540XA00A9E
TT	09/09-	<b>80871</b>	◁		515		26541XA01A9E
TT	09/09-	<b>80872</b>	▷		515		26541XA00A

# TUBI FLESSIBILI PER FRENO

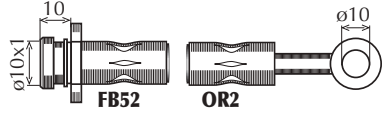
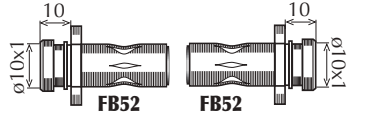

## ALTO II (EC)

0.8	01/86-11/93	<b>80117</b>	<>		457		5155084150
0.8	01/86-11/93	<b>80118</b>	<>		285		5157084050

## ALTO III (EF)

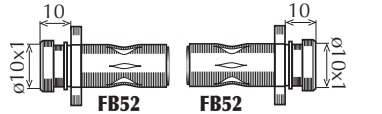
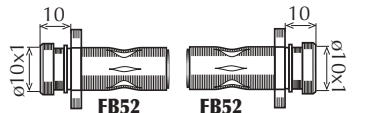
1.0	04/94-06/02	<b>80119</b>	<>		400		5158080131
1.0	04/94-06/02	<b>80118</b>	<>		285		5157084050

## ALTO IV (FF)

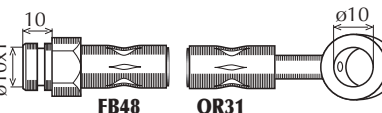
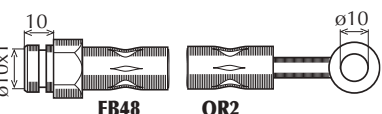
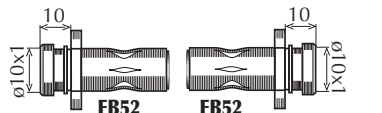
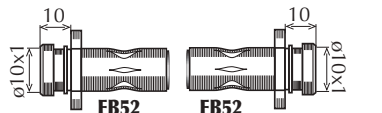
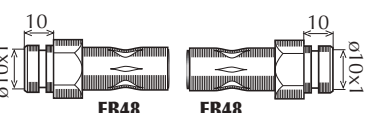
1.0	06/02-08/03	<b>80278</b>	<>		435		51550M70E10
1.0	08/03-	<b>80276</b>	<>		465		51550M76G10
1.0	06/02-08/03	<b>80118</b>	>		285		5157084050
1.0	06/02-08/03	<b>80121</b>	<		243		5157050A50
1.0	08/03-	<b>80259</b>	<>		300		51570M76G10

## ALTO V (GF)

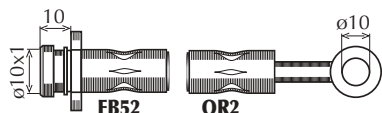
TT	01/09-	<b>80874</b>	<		463		51540M68K00000
----	--------	--------------	---	--	-----	--	----------------

## TUBI FLESSIBILI PER FRENO



**o.e.**

### segue ALTO V (GF)

TT	01/09-	<b>80875</b>	>		455		51550M68K00000
TT	01/09-	<b>80876</b>	<>		255		51570M68K00000

### BALENO (EG), BALENO SW (EG)

TT	07/95-	<b>80120</b>	<>		410		5158060G00
TT	07/95-	<b>80121</b>	<>		243		5157050A50

### GRAND VITARA (FT-GT)

TT	03/98-	<b>80601</b>	>		760		5154065D00
TT	03/98-	<b>80602</b>	<		760		5155065D00
TT (alla pompa freno)	03/98-	<b>80230</b>			210		5157060A30
TT	03/98-	<b>80280</b>	<>		257		5156065D00

### GRAND VITARA (JT)

TT	04/05-	<b>80691</b>	<		535		5155065J00
TT	04/05-	<b>80692</b>	>		535		5154065J00

Legenda/Legend: ○ = Intermedio/Intermediate - ● = Interno/Inner - ▲ = Superiore/Upper - ▼ = Inferiore/Lower

# TUBI FLESSIBILI PER FRENO



L



o.e.

## segue GRAND VITARA (JT)

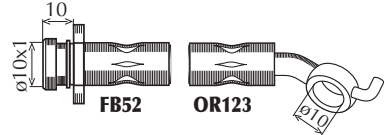
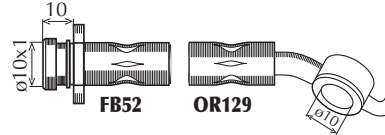
TT (alla pompa freno)	04/05-	<b>80693</b>	◀	385		5158077K00
TT	04/05-	<b>80694</b>	▼	385		5157077K00



## IGNIS (FH)

1.3 4WD	10/00-09/03	<b>8933</b>	◀ ▶	305		5157076G00
---------	-------------	-------------	-----	-----	--	------------

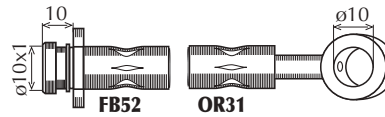
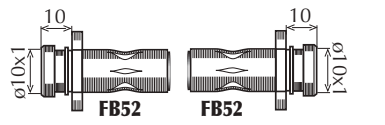
## IGNIS II

TT	09/03-	<b>8932</b>	◀ ▶	440		5155083E00
TT	09/03-	<b>80270</b>	◀ ▶	307		5157083E00

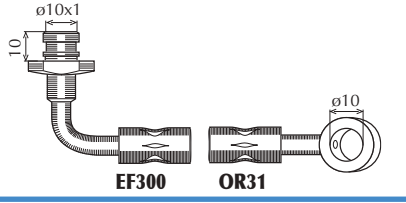
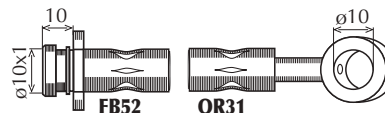
## JIMNY

TT	09/98-	<b>80695</b>	◀	515		5155081A00
TT	09/98-	<b>80696</b>	▼	355		5154081A00
TT	09/98-	<b>80939</b>	◀ ▶	385		5156081A00

## LIANA

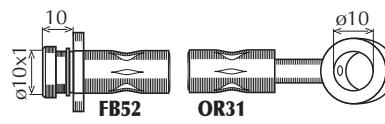
TT	07/01-	<b>80279</b>	◀ ▶	435		5158059J00
----	--------	--------------	-----	-----	--	------------



## TUBI FLESSIBILI PER FRENO



L



o.e.

### segue LIANA

TT	09/03-	<b>80121</b>	<>	243	<p>FB52      FB52</p>	5157050A50
----	--------	--------------	----	-----	-----------------------	------------

### SJ 410, SJ 413, SANTANA

TT	09/81-	<b>8514</b>	<>	295	<p>MC22      OR2</p>	51540C80150
TT (intermedio)	09/81-	<b>8525</b>	○	180	<p>MC11      MC22</p>	51570BB3030
TT	09/81-	<b>8524</b>	<>	395	<p>MC11      MC22</p>	51580BB0130

### SJ 413 (SJ50-SJ70)

1.3	09/84-08/90	<b>80229</b>	<>	280	<p>FB52      OR33</p>	5154080151
1.3	09/84-08/90	<b>8952</b>	<>	300	<p>FB52      FB52</p>	5156083031

### SPLASH

TT	01/08-	<b>80603</b>	<>	520	<p>FB52      OR90</p>	5155062J00000
TT	01/08-	<b>80604</b>	>	325	<p>FB52      FB52</p>	5157062J00000
TT	01/08-	<b>80605</b>	<	330	<p>FB52      FB52</p>	5158062J00000

# TUBI FLESSIBILI PER FRENO



L



o.e.

## SWIFT II (AH, AJ)

### 1.3

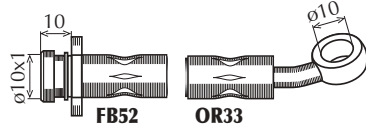
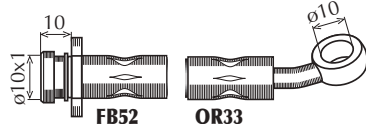
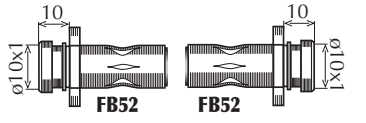
TT	03/89-	<b>80122</b>	<>		480		5158060B00
TT	08/94-	<b>80108</b>	<>		475		5158063B00
TT	03/89-	<b>80123</b>		<>	365		5159060B00

### 1.6

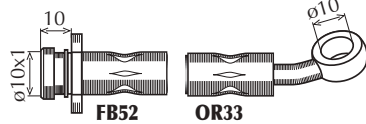
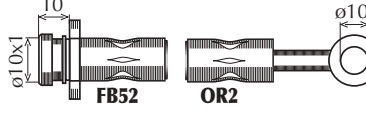
1.6, 1.6 4WD	11/89-	<b>80108</b>	<>		475		5158063B00
1.6, 1.6 4WD	11/89-	<b>80124</b>		<>	598		5159064B00

## SWIFT II Hatchback (EA)

### 1.0

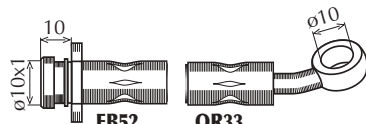
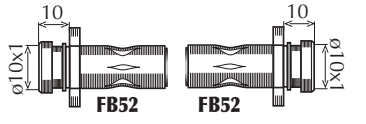
TT	03/89-	<b>80122</b>	<>		480		5158060B00
TT	03/89-	<b>80123</b>		<>	365		5159060B00

### 1.3

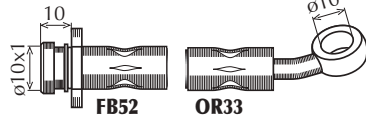
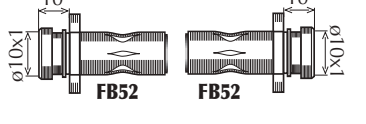
TT	08/94-	<b>80122</b>	<>		480		5158060B00
TT	08/94-	<b>80123</b>		<>	365		5159060B00

## TUBI FLESSIBILI PER FRENO

**L**

**o.e.**

### segue SWIFT II Hatchback (EA)

#### 1.3 GTI

TT	03/89-	<b>80108</b>	<>		475	 FB52 OR33	5158063B00
TT	03/89-	<b>80124</b>	<>		598	 FB52 OR2	5159064B00

### SWIFT II Roadster (SF413)

TT	09/91-	<b>80122</b>	<>		480	 FB52 OR33	5158060B00
TT	09/91-	<b>80123</b>	<>		365	 FB52 FB52	5159060B00

### SWIFT III

TT	02/05-	<b>80603</b>	<>		520	 FB52 OR90	5155062J00000
TT	02/05-	<b>80604</b>	>		325	 FB52 FB52	5157062J00000
TT	02/05-	<b>80605</b>	<		330	 FB52 FB52	5158062J00000

### SX4

TT	06/06-	<b>80449</b>	<>		405	 FB52 OR52	5155079J00000
TT	06/06-	<b>80298</b>	<>		325	 FB52 FB52	5157079J00000

# TUBI FLESSIBILI PER FRENO

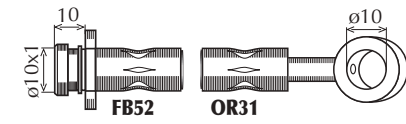
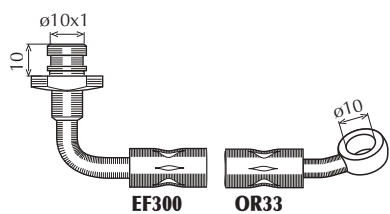
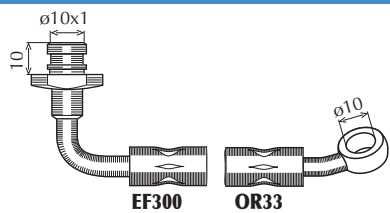
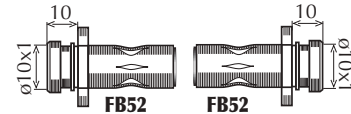

## VITARA

TT	88-03/99	8950	>		545		5154060A31
TT	88-03/99	8951	<		737		5155060A31
2.0, 2.0 16V, 2.5 TD (- ABS)	01/95-03/99	8951	<>		737		5155060A31
TT	88-03/99	8952	<>	<>	300		5156083031

## WAGON R+ (EM)

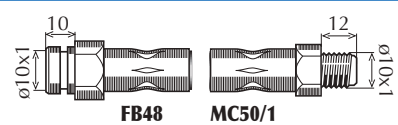
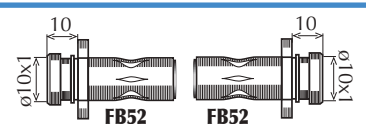
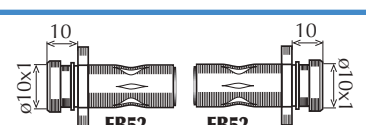
TT	02/95-5/00	80358	<>		420		5155075F00
TT	02/95-5/00	80121		>	243		5157050A50
TT	02/95-5/00	80271		<	243		5158075F00

## WAGON R+ (MM)

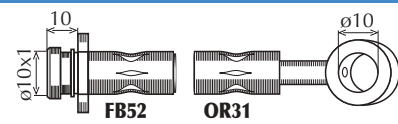
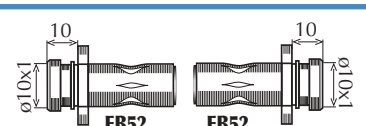
TT	05/00-	8932	<>		440		5155083E00
TT	05/00-	80270		<>	307		5157083E00

## TUBI FLESSIBILI PER FRENO



L



o.e.

### 1307, 1308, 1309

TT	75-82	8330	<>	333	<p>11 13  <math>\phi 10 \times 1</math> <math>\phi 10 \times 1</math>  <b>F2 MC11</b></p>	156025
----	-------	------	----	-----	---	--------

### HORIZON

TT	02/78-06/86	8330	<>	333	<p>11 13  <math>\phi 10 \times 1</math> <math>\phi 10 \times 1</math>  <b>F2 MC11</b></p>	156025
----	-------------	------	----	-----	---	--------

### SAMBA

1.0, 1.1, 1.4	82-86	8383	<>	370	<p>9 13  <math>\phi 10 \times 1</math> <math>\phi 10 \times 1</math>  <b>FB23 MC11</b></p>	480620
1.0, 1.1, 1.4	82-86	8384	▼	333	<p>9 9  <math>\phi 10 \times 1</math> <math>\phi 10 \times 1</math>  <b>FB23 FB23</b></p>	481623
1.0, 1.1, 1.4	82-86	8385	▲	333	<p>9 13  <math>\phi 10 \times 1</math> <math>\phi 10 \times 1</math>  <b>FB23 MC11</b></p>	481621

### SOLARA (1510)

TT	08/79-07/86	8330	<>	333	<p>11 13  <math>\phi 10 \times 1</math> <math>\phi 10 \times 1</math>  <b>F2 MC11</b></p>	156025
----	-------------	------	----	-----	---	--------

### SIMCA 1000

#### 944

0.9	68-80	8308	<>	288	<p>12 11,5  <math>\phi 3/8''-24\text{fil.}</math> <math>\phi 3/8''-24\text{fil.}</math>  <b>FB8 MP4</b></p>	553843
0.9	68-80	8280	▼	320	<p>12 12  <math>\phi 3/8''-24\text{fil.}</math> <math>\phi 3/8''-24\text{fil.}</math>  <b>FB11 FB11</b></p>	552889
0.9	68-80	8095	▲	298	<p>12 11,5  <math>\phi 3/8''-24\text{fil.}</math> <math>\phi 3/8''-24\text{fil.}</math>  <b>FB8 MP4</b></p>	543386

**TUBI FLESSIBILI PER FRENO**

**L**

**o.e.**
**segue SIMCA 1000**
**1100, 1300**

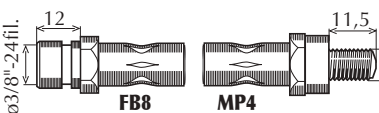
TT	68-80	<b>8280</b>	<>		320	 <b>FB11</b> <b>FB11</b>	552889
TT	68-80	<b>8095</b>	<>		298	 <b>FB8</b> <b>MP4</b>	543386

**TAGORA**

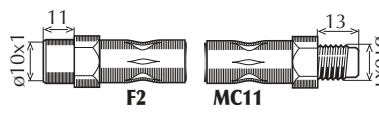
2.2, 2.3 TD	80-87	<b>8330</b>	<>		333	 <b>F2</b> <b>MC11</b>	156025
-------------	-------	-------------	----	--	-----	---	--------

## TUBI FLESSIBILI PER FRENO



L



o.e.

### TALBOT COMMERCIALI

#### EXPRESS



TT (- 4x4) (Superiore)	10/81-01/83	<b>8364</b>	<>		388		
TT (- 4x4) (Inferiore)	10/81-01/83	<b>8365</b>	<>		388		480624
TT (- 4x4) (Superiore)	02/83-02/94	<b>8410</b>	<>		460		480636
TT (- 4x4) (Inferiore)	02/83-02/94	<b>8411</b>	<>		460		480635
TT (- 4x4)	10/81-02/94	<b>8354</b>	<>	<>	284		481627

Legenda/Legend: ○ = Intermedio/Intermediate - ● = Interno/Inner - ▲ = Superiore/Upper - ▼ = Inferiore/Lower

## TUBI FLESSIBILI PER FRENO

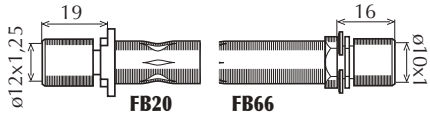

### 4 RUNNER (N130)

TT	08/87-03/96	<b>80145</b>	<>		470		9094702383
TT	08/87-03/96	<b>80607</b>	<>		360		9094702599

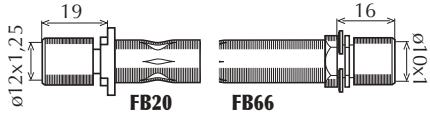
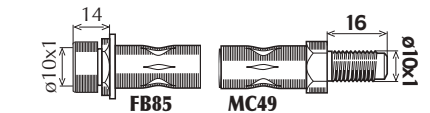

### 4 RUNNER

3.0 Turbo-D	11/95-	<b>80145</b>	<>		470		9094702383
3.0 Turbo-D	11/95-	<b>80607</b>	<>		360		9094702599

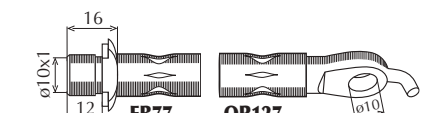
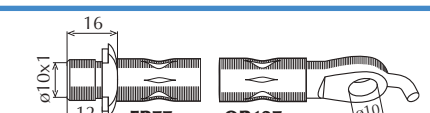
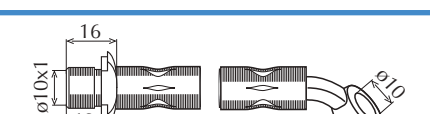
### AURIS

TT	10/06-	<b>80878</b>	<		670		90947W2013
TT	10/06-	<b>80879</b>	>		670		90947W2012
TT	10/06-	<b>80880</b>	<>		215		90947W2016

### AVENSIS (T22)

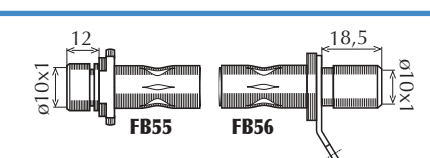
TT	10/97-02/03	<b>8953</b>	>		530		9008094060
TT	10/97-02/03	<b>8954</b>	<		530		9008094061
TT	10/97-02/03	<b>8955</b>	>		380		9008094065



## TUBI FLESSIBILI PER FRENO



L



o.e.

### segue AVENSIS (T22)

TT	10/97-02/03	<b>8956</b>	<	380		9008094066
----	-------------	-------------	---	-----	--	------------

### AVENSIS (T25)

TT	04/03-	<b>80405</b>	>	600		9008094199
TT	04/03-	<b>80406</b>	<	600		9008094200
TT	04/03-	<b>80365</b>	<>	280		9094702E85

### AVENSIS (T27)

TT	02/09-	<b>80883</b>	<	685		90947W2023
TT	02/09-	<b>80884</b>	>	685		90947W2022
TT	02/09-	<b>80885</b>	<>	360		9094702E30

### AVENSIS VERSO

TT	08/01-	<b>81006</b>	<>	593		9094702C78
TT	08/01-	<b>80620</b>	<>	205		9094702B95

## TUBI FLESSIBILI PER FRENO



L



o.e.

### AYGO

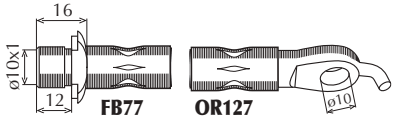
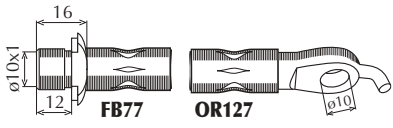
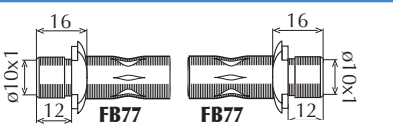
TT	06/05-	<b>80438</b>	▼		510		90947W2003
TT	06/05-	<b>80439</b>	▲		510		90947W2002
TT	06/05-	<b>80373</b>		◀▶	255		90947W2004

### CAMRY (V1-V2)

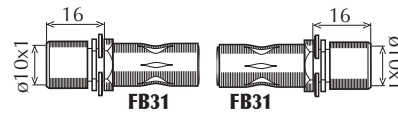
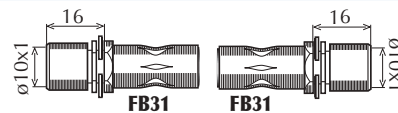
TT	10/82-05/91	<b>8537</b>		◀▶	560		9094702496
TT (V1)	10/82-12/86	<b>8538</b>		◀▶	350		9695033455
TT (V2)	10/86-05/91	<b>8539</b>		◀▶	370		9094702533

### CAMRY (V20)

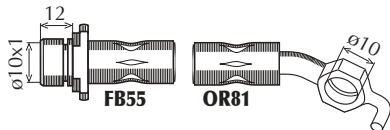
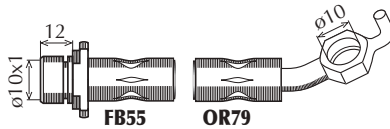
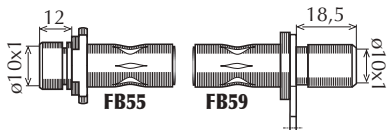
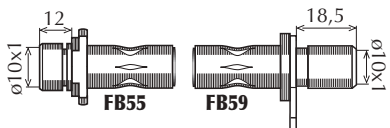
TT	08/96-11/01	<b>80410</b>	▼		520		9094702875
TT	08/96-11/01	<b>80401</b>	▲		520		9094702876
TT (Tamburo Post.)	08/96-11/01	<b>80310</b>	▼		375		9094702879
TT (Tamburo Post.)	08/96-11/01	<b>80326</b>	▲		375		9094702880

## TUBI FLESSIBILI PER FRENO



L



o.e.

### segue CAMRY (V20)

TT (Disco Post.)	08/96-11/01	<b>80403</b>	▼	500		9094702877
TT (Disco Post.)	08/96-11/01	<b>80402</b>	▲	500		9094702878

### CAMRY (V30)

TT	11/01-	<b>80608</b>	▼	460		9094702C89
TT	11/01-	<b>80609</b>	▲	460		9094702C90
TT	11/01-	<b>80413</b>	▼	575		9094702F60
TT	11/01-	<b>80408</b>	▲	575		9094702F61

### CARINA II

1.6, 1.8 Gli, 2.0 D	12/87-03/92	<b>80125</b>	<>	494		9094702565
1.6, 1.8 Gli, 2.0 D	12/87-03/92	<b>80126</b>	<>	370		9094702497

### CARINA E

TT	04/92-09/97	<b>80127</b>	▼	555		9094702821
TT	04/92-09/97	<b>80128</b>	▲	555		9094702820

## TUBI FLESSIBILI PER FRENO



o.e.

### segue CARINA E

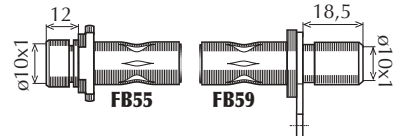
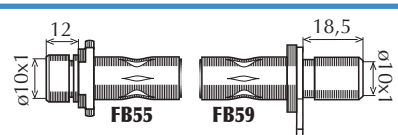
TT	04/92-09/97	<b>80129</b>	▼	360		9094702634
TT	04/92-09/97	<b>80130</b>	▲	355		9094702694

### CELICA (T16)

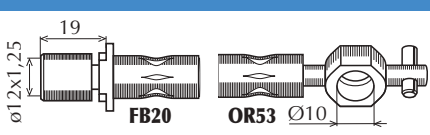
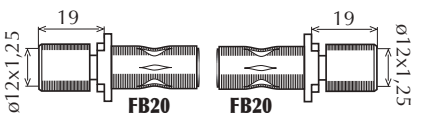
1.6, 1.6 GT, 2.0, 2.0 GT	04/86-08/90	<b>80131</b>	◁ ▷	479		9094702904
1.6, 1.6 GT, 2.0, 2.0 GT	04/86-08/90	<b>80132</b>	◁ ▷	382		9094702472

### CELICA (T20)

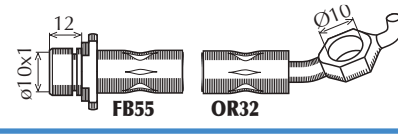
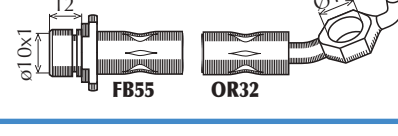
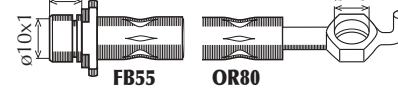
1.8, 2.0, 2WD	02/94-11/99	<b>80347</b>	▼	490		9094702848
1.8, 2.0, 2WD	02/94-11/99	<b>80355</b>	▲	485		9094702847
1.8, 2.0, 2WD	02/94-11/99	<b>80407</b>	◁ ▷	540		9094702852

### CELICA (ZZT23)

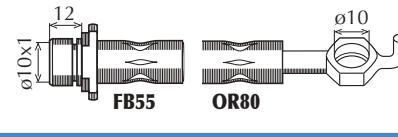
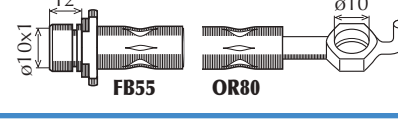
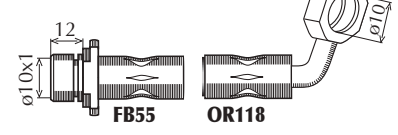
TT	11/99-	<b>80399</b>	▼	580		9094702C23
TT	11/99-	<b>80404</b>	▲	580		9094702C24
TT	11/99-	<b>80610</b>	◁ ▷	275		9094702A37

## TUBI FLESSIBILI PER FRENO



o.e.

### COROLLA (E8)

1.3, 1.6, 1.8 D	06/83-08/87	<b>80131</b>	<>		479		9094702904
1.3, 1.6, 1.8 D	06/83-08/87	<b>80133</b>	<>		347		9094702465

### COROLLA (E9)

1.3, 1.6, 1.8 D	08/87-06/93	<b>80134</b>	<>		486		9094702532
1.3, 1.6, 1.8 D	08/87-06/93	<b>8539</b>	<>		370		9094702533

### COROLLA (E10)

1.3, 1.6, 2.0 D	07/92-04/97	<b>8960</b>	>		470		9094702798
1.3, 1.6, 2.0 D	07/92-04/97	<b>8961</b>	<		470		9094702799
1.3, 1.6, 2.0 D	07/92-04/97	<b>8962</b>	<>		300		9094702809

### COROLLA (E11)

1.4, 1.6, 2.0 D	04/97-02/01	<b>8963</b>	>		473		9094702910
1.4, 1.6, 2.0 D	04/97-02/01	<b>8964</b>	<		483		9094702917
1.4, 1.6, 2.0 D	04/97-02/01	<b>8965</b>	<>		305		9094702921

Legenda/Legend: ○ = Intermedio/Intermediate - ● = Interno/Inner - ▲ = Superiore/Upper - ▼ = Inferiore/Lower

## TUBI FLESSIBILI PER FRENO



L



o.e.

### COROLLA (E12)

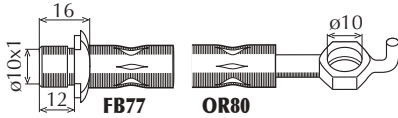
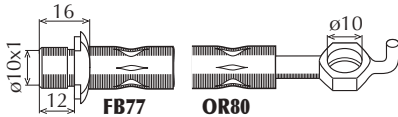
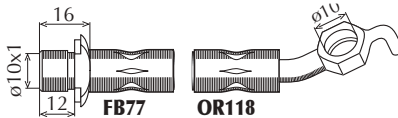
TT	02/01-	80405	▼		600		9008094199
TT	02/01-	80406	▲		600		9008094200
TT	02/01-	80611	<>		225		9008094133

### COROLLA VERSO (E12J)

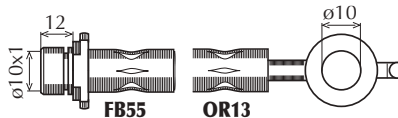
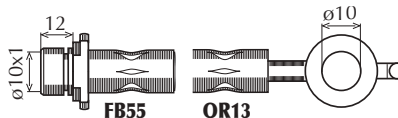
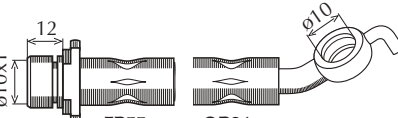
TT	01/02-05/04	80348	▼		595		9094702C47
TT	01/02-05/04	80345	▲		595		9094702C48
TT	01/02-05/04	80324	<>		235		9094702C50

### COROLLA VERSO (R1\_)

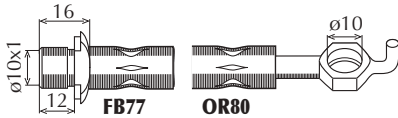
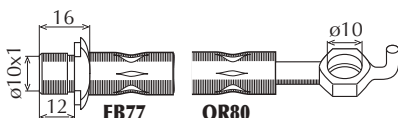
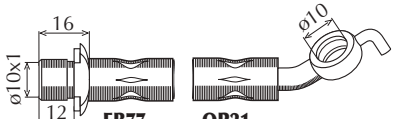
TT	04/04-	80405	▼		600		9008094199
TT	04/04-	80406	▲		600		9008094200
TT	04/04-	80364	<>		245		9094702E84

### HIACE II (H5\_)

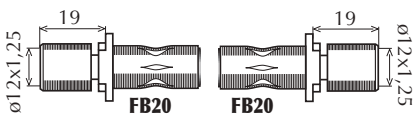
1.8, 2.0, 2.2 D, 2.4 D	03/83-11/89	80135	<>		305		9094702477
------------------------	-------------	-------	----	--	-----	--	------------

## TUBI FLESSIBILI PER FRENO



**o.e.**

### segue HIACE II (H5\_)

1.8, 2.0, 2.2 D, 2.4 D	03/83-11/89	<b>80136</b>	<>	318		9694033205
------------------------	-------------	--------------	----	-----	--	------------

### HIACE III (H10\_)

2.0, 2.4, 2.4 D	08/89-08/95	<b>80137</b>	>	352		9094702757
2.0, 2.4, 2.4 D	08/89-08/95	<b>80138</b>	<	352		9094702758
2.0 (intermedio)	08/89-08/95	<b>80139</b>	<>	345		9694033455
2.4, 2.4 D (intermedio)	08/89-07/93	<b>80139</b>	<>	345		9694033455
2.4, 2.4 D (intermedio)	08/93-08/95	<b>80140</b>	<>	380		9694033805

### HIACE IV (H1 , H2)

TT	08/95-	<b>80141</b>	>	258		9094702833
TT	08/95-	<b>80142</b>	<	258		9094702834
TT	08/95-	<b>80143</b>	<>	235		9094702828

Legenda/Legend: ○ = Intermedio/Intermediate - ● = Interno/Inner - ▲ = Superiore/Upper - ▼ = Inferiore/Lower

## TUBI FLESSIBILI PER FRENO





L



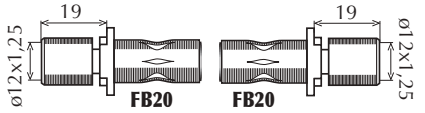
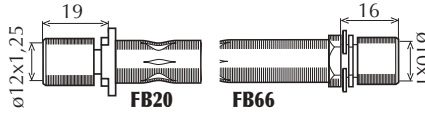
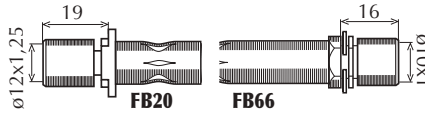
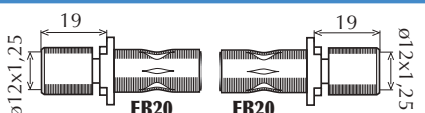

o.e.

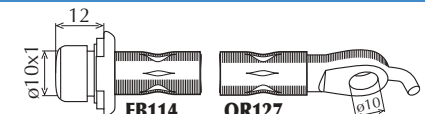

### HILUX Pickup (N)

1.8, 2.4 D	03/89-	<b>80144</b>	<>		345		9094702581
2.0, 2.2 4WD, 2.4 4WD	08/88-	<b>80145</b>	<>		470		9094702383
2.4 D 4WD	08/83-08/97	<b>80145</b>	<>		470		9094702383
2.4 D 4WD	08/97-	<b>8114</b>	<>		340		9094702957
TT (intermedio)	08/88-	<b>80146</b>	<>		431		9694034305

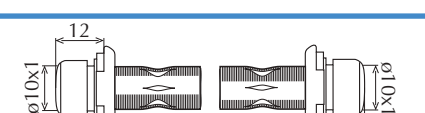
### IQ

TT	01/09-	<b>81007</b>	<		640		9094702G44
TT	01/09-	<b>81008</b>	>		640		9094702F92
TT	01/09-	<b>81009</b>	<		200		9094702F95
TT	01/09-	<b>81010</b>	>			Il disegno non è disponibile The drawing is not available	9094702F94

### LAND CRUISER (J6)

4.2, 4.0 D	10/81-01/88	<b>80147</b>	<>		185		9694039855
4.2, 4.0 D	10/81-10/84	<b>80148</b>	<>		354		9804033605



## TUBI FLESSIBILI PER FRENO



o.e.

### segue LAND CRUISER (J6)

4.2, 4.0 D	11/84-01/88	80140	<>	>	380		9694033805
------------	-------------	-------	----	---	-----	--	------------

### LAND CRUISER (J7)

3.0 Hardtop, 2.4 TD	05/93-05/96	80147	<>	>	185		9694039855
---------------------	-------------	-------	----	---	-----	--	------------

3.0 Hardtop	05/93-05/96	80146	<>	>	431		9694034305
-------------	-------------	-------	----	---	-----	--	------------

### LAND CRUISER (J8)

TT	10/92-12/97	80612	>	>	265		9094702614
----	-------------	-------	---	---	-----	--	------------

TT	10/92-12/97	80613	>	>	270		9094702615
----	-------------	-------	---	---	-----	--	------------

### LAND CRUISER (J9)

3.4 24V, 3.0 TD, 3.0 D-4D	04/96-	80286	<>	>	290		9094702B14
---------------------------	--------	-------	----	---	-----	--	------------

3.4 24V, 3.0 TD, 3.0 D-4D	04/96-	80612	>	>	265		9094702614
---------------------------	--------	-------	---	---	-----	--	------------

3.4 24V, 3.0 TD, 3.0 D-4D	04/96-	80613	>	>	270		9094702615
---------------------------	--------	-------	---	---	-----	--	------------

## TUBI FLESSIBILI PER FRENO



L



o.e.

### LAND CRUISER 100 (J10)

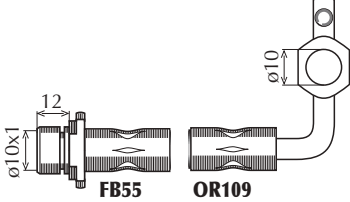
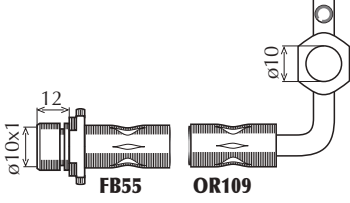
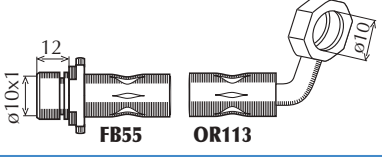
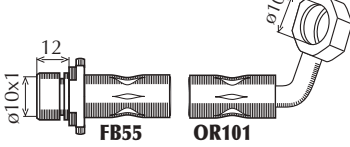
4.7 V8, 4.2 TD	01/98-	<b>80614</b>	▼		415		9094702F28
4.7 V8, 4.2 TD	01/98-	<b>80615</b>	▲		415		9094702F29
4.7 V8, 4.2 TD	01/98-	<b>80616</b>	▼		260		9094702F25
4.7 V8, 4.2 TD	01/98-	<b>80617</b>	▲		260		9094702F26

### LAND CRUISER (J12)

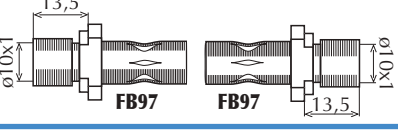
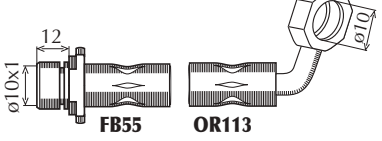
3.0 D-4D	09/02-	<b>80699</b>	<>		280		9094702F20
3.0 D-4D	09/02-	<b>80700</b>	<>		265		9094702F24

### LAND CRUISER (J20)

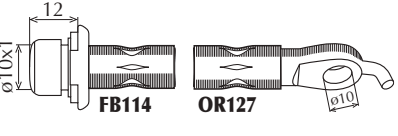
4.5 D V8, 4.8 V8	11/07-	<b>80704</b>	▲			Il disegno non è disponibile The drawing is not available	9094702F43
4.5 D V8, 4.8 V8	11/07-	<b>80705</b>	▼			Il disegno non è disponibile The drawing is not available	9094702F42
4.5 D V8, 4.8 V8	11/07-	<b>80706</b>	<>		335		9094702F37

## TUBI FLESSIBILI PER FRENO



L



o.e.

### LAND CRUISER 150 (J15)

3.0 D-4D	01/09-	80701	<>		285		9094702G20
3.0 D-4D	01/09-	80702	<			Il disegno non è disponibile The drawing is not available	9094702G16
3.0 D-4D	01/09-	80703	>			Il disegno non è disponibile The drawing is not available	9094702G15

### PASEO (EL54)

1.5 16V	8/95-7/99	80618	>		470		9094702813
1.5 16V	8/95-7/99	80619	<		465		9094702814
1.5 16V	8/95-7/99	80323	<>		285		9094702637



### PICNIC (XM10)

TT	09/96-12/01	80127	>		555		9094702821
TT	09/96-12/01	80128	<		555		9094702820
TT	09/96-04/00	80297	<>		225		9094702874
TT	04/00-12/01	80302	<>		220		9094702C39



## TUBI FLESSIBILI PER FRENO

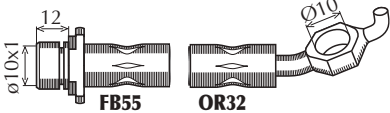
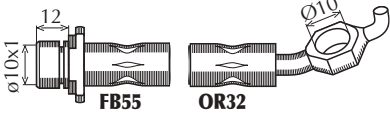
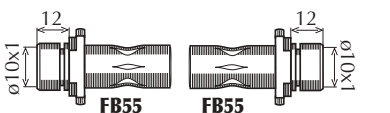

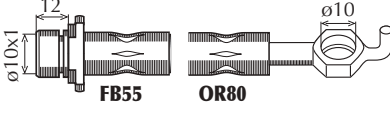
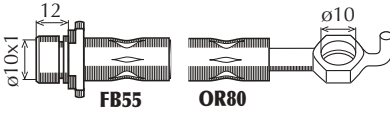

### PREVIA (ACR3\_)

TT	08/00-	<b>80344</b>	▼		450		9094702B96
TT	08/00-	<b>80353</b>	▲		450		9094702B97
TT	08/00-	<b>80287</b>		↔	245		9094702B46
TT (alla pinza)	08/00-	<b>80620</b>		↔	205		9094702B95

### PRIUS

TT	08/00-	<b>80409</b>	▼		595		9094702F17
TT	08/00-	<b>80400</b>	▲		595		9094702D82
TT	08/00-	<b>80621</b>		↔	235		9094702F16

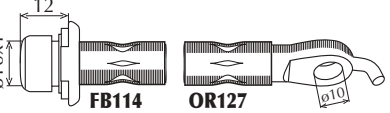
### PRIUS (Mod.2009)

TT	01/09-	<b>80886</b>	▲		735		9094702F84
TT	01/09-	<b>80887</b>	▼		735		9094702F83
TT	01/09-	<b>80888</b>		↔		Il disegno non è disponibile The drawing is not available	9094702F87



## TUBI FLESSIBILI PER FRENO





L



o.e.

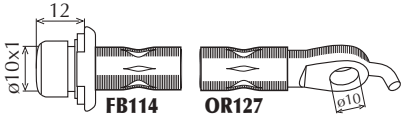

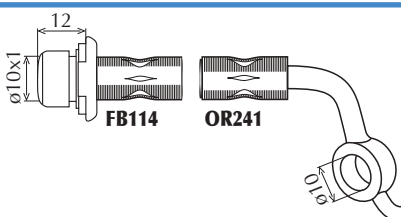
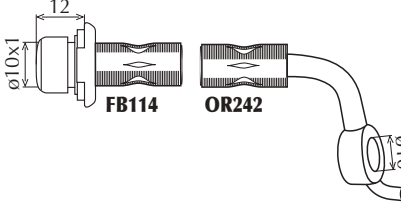
### RAV 4 III

TT	11/05-	<b>80650</b>	▼		690		9094702F49
TT	11/05-	<b>80651</b>	▲		690		9094702F50
TT	11/05-	<b>80652</b>	▼		300		9094702F51
TT	11/05-	<b>80653</b>	▲		300		9094702F52

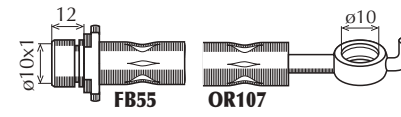
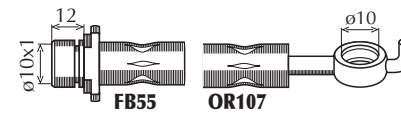
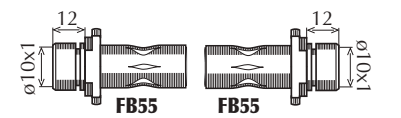
### STARLET (EP91)

TT	04/96-03/99	<b>80618</b>	▼		470		9094702813
TT	04/96-03/99	<b>80619</b>	▲		465		9094702814
TT	04/96-03/99	<b>80323</b>	◀▶		285		9094702637

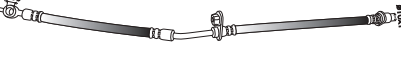
### URBAN CRUISER

TT	04/09-	<b>80889</b>	▲				9094702E08
TT	04/09-	<b>80890</b>	▼				9094702E07
TT	04/09-	<b>80891</b>	◀▶		265		9094702E11

## TUBI FLESSIBILI PER FRENO



L



o.e.

### VERSO

TT	04/09-	80881	▲		195		90947W2014
TT	04/09-	80882	▼		160		90947W2015
TT	04/09-	80880		◀▶	215		90947W2016

### VERSO S

TT	11/10-	80889	▲				9094702E08
TT	11/10-	80890	▼				9094702E07
TT	11/10-	80891		◀▶	265		9094702E11

### YARIS I

TT	08/99-	8957	▼		560		9094702C31
TT	08/99-	8958	▲		560		9094702C32
TT	08/99-	8959		◀▶	315		9094702C30

### YARIS II

TT	01/06-	80889	▲				9094702E08
----	--------	-------	---	--	--	--	------------

## TUBI FLESSIBILI PER FRENO





L





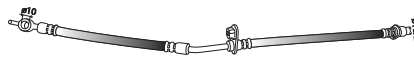

o.e.

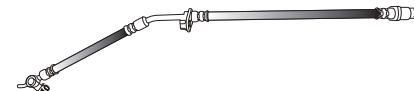
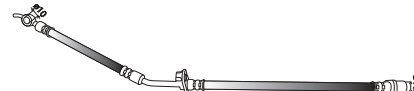

### segue YARIS II

TT	01/06-	<b>80890</b>	▼				9094702E07
TT	01/06-	<b>80891</b>		◀▶	265		9094702E11

### YARIS II (Made in France)

TT	01/06-	<b>80940</b>	▲				90947W2008
TT	01/06-	<b>80941</b>	▼				90947W2007
TT	01/06-	<b>80942</b>		▲	285		90947W2009
TT	01/06-	<b>80943</b>	▼		225		90947W2010
TT (freno a disco)	01/06-	<b>80944</b>		◀▶	265		90947W2011

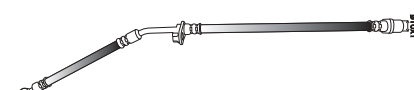
### YARIS III

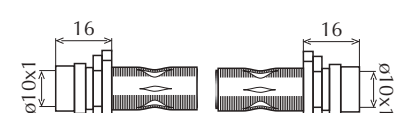
TT	09/11-	<b>81060</b>	▲				90947W2030
TT	09/11-	<b>81061</b>	▼				90947W2029
TT	09/11-	<b>81062</b>		▲	225		90947W2032



## TUBI FLESSIBILI PER FRENO



L



o.e.

### segue YARIS III

TT	09/11-	81063	>	285		90947W2031
----	--------	-------	---	-----	--	------------

### YARIS VERSO

TT	11/99-	8957	>	560		9094702C31
TT	11/99-	8958	<	560		9094702C32
TT	11/99-	8959	<>	315		9094702C30

## TUBI FLESSIBILI PER FRENO



L



o.e.

### 1200 - 1300 (Maggiolino)

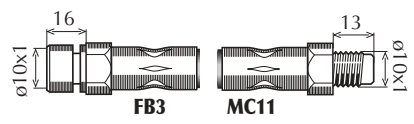
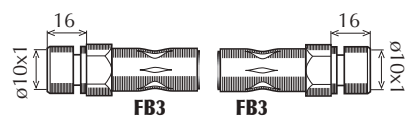
TT	09/66-09/78	8237	<>		350		
TT	09/66-09/78	8240	<>		236		211611775B

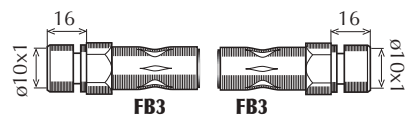
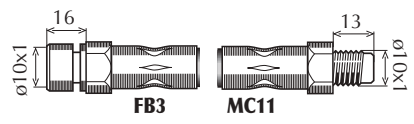

### 1302 - 1303 (Maggiolone)

TT	09/72-75	8238	<>		285		113611701E
TT	09/72-75	8239	<>		210		113611775E

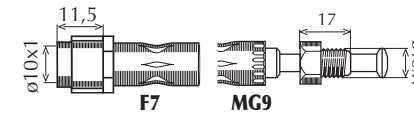
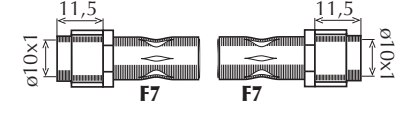
### AMAROK

TT	09/10-	81064	<>		590		2H0611701
TT	09/10-	81065	<>		335		2H0611775

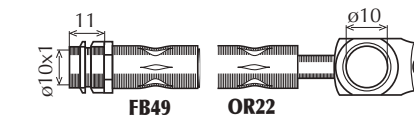
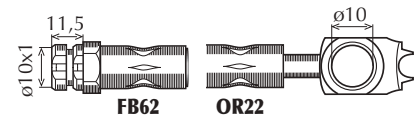
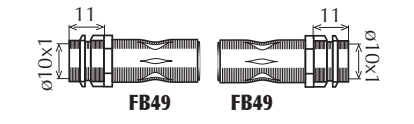
### BORA

TT (-4x4)	10/98-05/05	8616	<>		435		1J0611701
4x4	10/98-05/05	81071			580		1J0611701M
TT	10/98-05/05	8903	<>		165		6X0611775
TT (alla pinza)	10/98-05/05	80623		▼			1J0611764K

## TUBI FLESSIBILI PER FRENO



o.e.

### segue BORA

TT (alla pinza)	10/98-05/05	<b>80622</b>	<				1J0611763K
-----------------	-------------	--------------	---	--	--	--	------------

### CORRADO

1.8 16V, 1.8 G60	-07/91	<b>8550</b>	<>		370		535611701
TT	08/91-	<b>8551</b>	<>		485		1H0611701
TT	09/88-12/95	<b>8643</b>	<>		160		1H06117775
TT (alla pinza)	09/88-12/95	<b>8036</b>	<>		187		481611775

### DERBY

TT	77-09/81	<b>8226</b>	<>		290		801611707C
TT	77-09/81	<b>8227</b>	<>		180		433611775A

### EOS

TT	03/06-	<b>80160</b>	<>		595		1K0611701K
TT		<b>81020</b>	<>		525		1K0611701L
TT	03/06-10/09	<b>80892</b>	<>		265		1Q0611775A

Legenda/Legend: ○ = Intermedio/Intermediate - ● = Interno/Inner - ▲ = Superiore/Upper - ▼ = Inferiore/Lower

## TUBI FLESSIBILI PER FRENO



L



o.e.

### segue EOS

TT	11/09-	<b>80852</b>	<>	270		1K0611775D
----	--------	--------------	----	-----	--	------------

### FOX

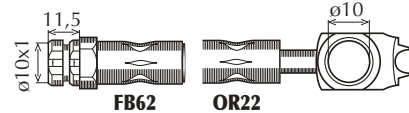
TT	04/05-	<b>80008</b>	<>	555		6Q0611701C
----	--------	--------------	----	-----	--	------------

TT	04/05-	<b>8903</b>	<>	165		6X0611775
----	--------	-------------	----	-----	--	-----------

### GOLF I

#### (04/74->10/78)

TT (Tamburo)	04/74-10/78	<b>8247</b>	<>	250		171611701
--------------	-------------	-------------	----	-----	--	-----------

TT (Pinza ATE)	04/74-10/78	<b>8234</b>	<>	326		171611701B
----------------	-------------	-------------	----	-----	--	------------

TT (Pinza Lucas)	04/74-10/78	<b>8248</b>	<>	306		171611701D
------------------	-------------	-------------	----	-----	--	------------

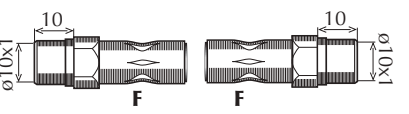
TT	04/74-10/78	<b>8229</b>	<>	160		171611775A
----	-------------	-------------	----	-----	--	------------

#### (11/78-07/83)

TT (Pinza ATE)	11/78-07/83	<b>8228</b>	<>	310		171611701G
----------------	-------------	-------------	----	-----	--	------------

TT (Pinza Lucas)	11/78-07/83	<b>8249</b>	<>	266		171611701K
------------------	-------------	-------------	----	-----	--	------------

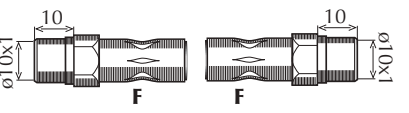
TT	11/78-07/83	<b>8229</b>	<>	160		171611775A
----	-------------	-------------	----	-----	--	------------

## TUBI FLESSIBILI PER FRENO



L



o.e.

### GOLF II

TT	08/83-10/91	<b>8228</b>	<>		310		171611701G
1.8 GTI (CH: 1GKW240001 -/Ch1GKB075001-)	-10/91	<b>80247</b>	<>		315		191611701A
TT	08/83-10/91	<b>8229</b>	<>		160		171611775A
1.8 GTI, 1.8 GTI G60 (alla pinza)	08/88-10/91	<b>8036</b>	<>		187		481611775

### GOLF III

TT	10/91-08/97	<b>8551</b>	<>		485		1H0611701
TT	10/91-08/97	<b>8643</b>	<>		160		1H0611775
1.6 (101 CV), 1.8, 2.0, 2.0 16V GTI, 2.8 VR6, 1.9 TDI (110 CV) (alla pinza)	10/91-08/97	<b>8036</b>	<>		187		481611775

### GOLF IV

TT (-4x4)	08/97-06/05	<b>8616</b>	<>		435		1J0611701
4x4	10/98-05/05	<b>81071</b>	<>		580		1J0611701M
TT	08/97-06/05	<b>8903</b>	<>		165		6X0611775
TT (alla pinza)	08/97-06/05	<b>80623</b>	>				1J0611764K

Legenda/Legend: ○ = Intermedio/Intermediate - ● = Interno/Inner - ▲ = Superiore/Upper - ▼ = Inferiore/Lower

## TUBI FLESSIBILI PER FRENO



L



o.e.

### segue GOLF IV

TT (alla pinza)	08/97-06/05	<b>80622</b>	<				1J0611763K
-----------------	-------------	--------------	---	--	--	--	------------

### GOLF V

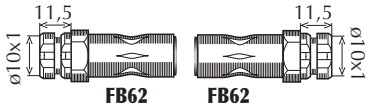
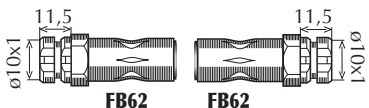
TT	10/03-	<b>80160</b>	<>		595		1K0611701B
TT		<b>81020</b>	<>		525		1K0611701L
TT	10/03-	<b>80161</b>	<>		257		1K0611775C

### GOLF V PLUS

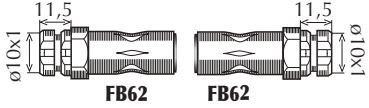
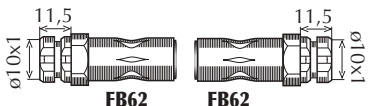
TT	01/05-	<b>80160</b>	<>		595		1K0611701B
TT		<b>81020</b>	<>		525		1K0611701L
TT	01/05-	<b>80161</b>	<>		257		1K0611775C

### GOLF VI

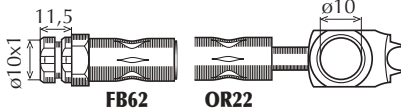
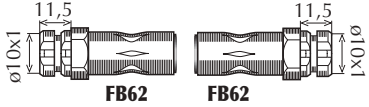
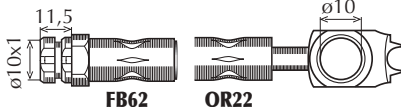
TT	10/08-	<b>80160</b>	<>		595		1K0611701B
TT		<b>81020</b>	<>		525		1K0611701L
TT	10/08-	<b>80852</b>	<>		270		1K0611775D

## TUBI FLESSIBILI PER FRENO



o.e.

### GOLF VII

TT	11/12-	<b>81066</b>	<>		650		5Q0611701C
TT	11/12-	<b>81067</b>	<>		305		5Q0611775J

### JETTA I

TT	08/79-12/83	<b>8228</b>	<>		310		171611701G
TT	08/79-12/83	<b>8249</b>	<>		266		171611701K
TT	08/79-12/83	<b>8229</b>	<>		160		171611775A

### JETTA II

TT	01/84-12/91	<b>8228</b>	<>		310		171611701G
1.8 16V (CH:1GKW240001 -/Ch1GKB075001-)	-12/91	<b>80247</b>	<>		315		191611701A
TT	01/84-12/91	<b>8229</b>	<>		160		171611775A
1.8 16V (alla pinza)	01/89-12/91	<b>8036</b>	<>		187		481611775

### JETTA III

TT	08/05-	<b>80160</b>	<>		595		1K0611701B
----	--------	--------------	----	--	-----	--	------------

## TUBI FLESSIBILI PER FRENO





L



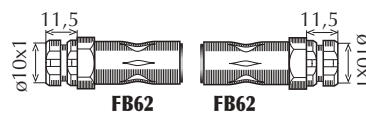
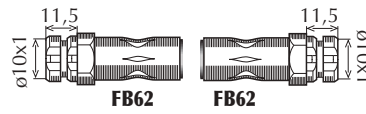

o.e.

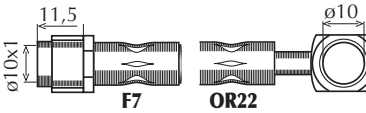

### segue JETTA III

TT		<b>81020</b>	<>		525		1K0611701L
TT	08/05-CH:1KA048000	<b>80161</b>	<>		257		1K0611775C
TT	CH:1KA048001-	<b>80852</b>	<		270		1K0611775D

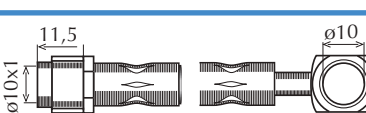
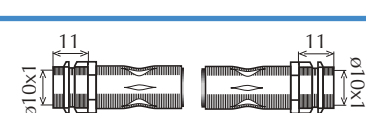
### LUPO

1.0,1.4,1.4 16V, 1.4 TDI,1.7 SDI	04/98-07/05	<b>8966</b>	<>		410		6N0611701/AB
1.2 TDI 3L	07/99-07/05	<b>80624</b>	<>		410		6E0611701C
1.4 FSI, 1.6 GTI	09/00-07/05	<b>80166</b>	<>		420		6E0611701B
TT	04/98-07/05	<b>8903</b>	<>		165		6X0611775

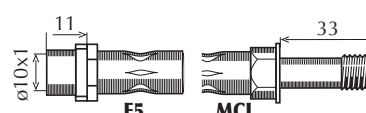
### MULTIVAN (04/03-11/09)

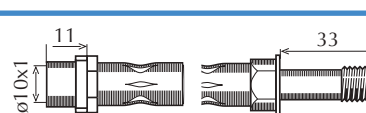
TT	04/03-11/09	<b>80167</b>	<>		558		7H0611701B
TT (intermedio)	04/03-11/09	<b>80168</b>	<>		275		7H0611775
TT	04/03-11/09	<b>80228</b>	<>		240		7H0611776



## TUBI FLESSIBILI PER FRENO



o.e.

### MULTIVAN (09/09-)

TT	09/09-	80895	<>		565		7H0611701D
TT (intermedio)	09/09-	80896	<>		275		7H0611775B
TT	09/09-	81022	<>		245		7H0611776C

### NEW BEETLE

TT (-3.2)	10/98-	8616	<>		435		1J0611701
3.2	04/00-05/01	80275	<>		575		8N0611707A
TT	10/98-	8903	<>		165		6X0611775
TT (alla pinza)	10/98-	80623	▼				1J0611764K
TT (alla pinza)	10/98-	80622	▲				1J0611763K

### BEETLE (5C1) Maggiolino (Mod 2011)

TT	10/11-	81068	<>		590		561611701
TT	10/11-	81069	<>		270		561611775

Legenda/Legend: ○ = Intermedio/Intermediate - ● = Interno/Inner - ▲ = Superiore/Upper - ▼ = Inferiore/Lower

## TUBI FLESSIBILI PER FRENO



L



o.e.

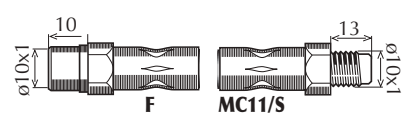
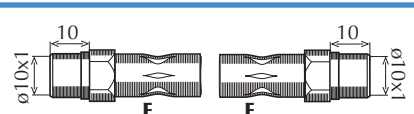
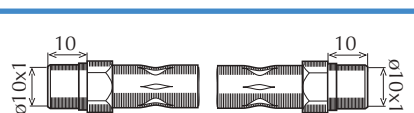

### PASSAT (32, 32B)

TT (Pinza ATE)	73-03/88	<b>8228</b>	<>		310		171611701G
TT (Pinza Lucas)	73-03/88	<b>8249</b>	<>		266		171611701K
TT	73-03/88	<b>8227</b>	<>		180		433611775A
TT (32B) Syncro	05/84-07/88	<b>8254</b>	<>		265		443611775A

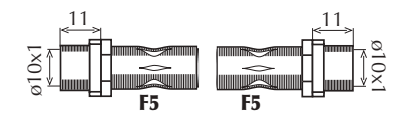
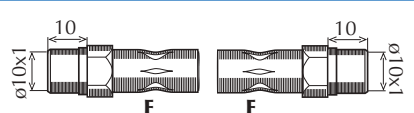
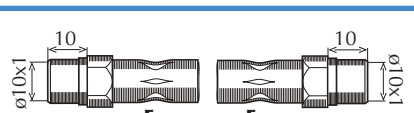
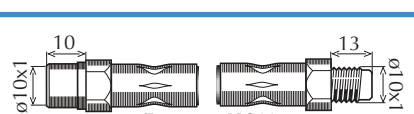
### PASSAT (3A2, 35I)

TT	04/88-05/97	<b>8550</b>	<>		370		535611701
TT	04/88-09/93	<b>8227</b>	<>		180		433611775A
TT	10/93-05/97	<b>8229</b>	<>		160		171611775
1.8 16V, 1.8 G60, 2.0, 2.0 16V, 2.8 VR6, 1.9 TDI (alla pinza)	01/89-05/97	<b>8036</b>	<>		187		481611775

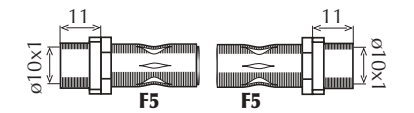
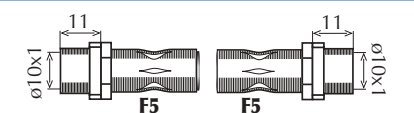
### PASSAT (3B2)

TT	10/96-11/00	<b>8035</b>	<>		310		8D0611707
TT	10/96-11/00	<b>8061</b>	<>		205		8D0611775E
TT ->CH:3BX600000	10/96->	<b>8968</b>	<>		225		8E0611775J

## TUBI FLESSIBILI PER FRENO



o.e.

### segue PASSAT (3B2)

TT Syncro (alla pinza)	10/96-11/00	<b>80248</b>	<>	330		4B0611775C
------------------------	-------------	--------------	----	-----	--	------------

### PASSAT (3B3)

TT	11/00-05/05	<b>8035</b>	<>	310		8D0611707
TT (DISCO Diam. 321/334)	11/00-05/05	<b>80163</b>	<>	384		4D0611707F
TT	11/00-05/05	<b>8061</b>	<>	205		8D0611775E
TT Syncro (alla pinza)	11/00-05/05	<b>80248</b>	<>	330		4B0611775C

### PASSAT (3C2)

TT	08/05-	<b>80392</b>	<>	615		3C0611701H
TT	08/05-	<b>80161</b>	<>	257		3C0611775C

### PASSAT (362, 365)

TT	08/10-	<b>81011</b>	<>	615		3AA611701A
TT	08/10-	<b>80894</b>	<>	270		5N0611775

### PHAETON

TT	04/02-	<b>81012</b>	<>	450		3D0611701E
----	--------	--------------	----	-----	--	------------

Legenda/Legend: ○ = Intermedio/Intermediate - ● = Interno/Inner - ▲ = Superiore/Upper - ▼ = Inferiore/Lower

## TUBI FLESSIBILI PER FRENO



L



o.e.

### segue PHAETON

TT	04/02-	<b>81013</b>	<>	190	 	3D0611775G
----	--------	--------------	----	-----	--	------------

### POLO I-II (86, 86C, 80)

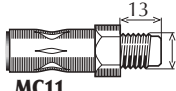
TT	09/75-09/94	<b>8226</b>	<>	290	 	861611707B
----	-------------	-------------	----	-----	--	------------

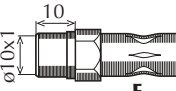
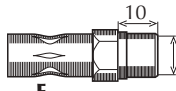
TT	09/75-09/94	<b>8227</b>	<>	180	 	433611775A
----	-------------	-------------	----	-----	--	------------

### POLO III (6N1, 6N2)

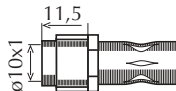
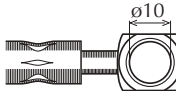
TT	10/94-09/01	<b>8966</b>	<>	410	 	6N0611701/A/B
----	-------------	-------------	----	-----	--	---------------

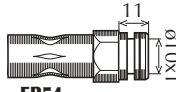
TT(- 1.4 16V)	10/94-09/01	<b>8967</b>	<>	165	 	6N0611775A
---------------	-------------	-------------	----	-----	--	------------

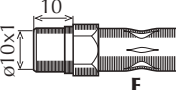
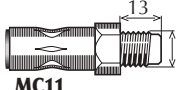
1.4 16V	04/96-09/01	<b>8036</b>	<>	187	 	893611775A
---------	-------------	-------------	----	-----	--	------------

### POLO IV (9N\_)

TT	10/01-	<b>80008</b>	<>	555	 	6Q0611701C
----	--------	--------------	----	-----	--	------------

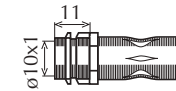
TT	10/01-	<b>8903</b>	<>	165	 	6X0611775
----	--------	-------------	----	-----	--	-----------

### POLO V (6R) (06/09->)

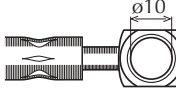
TT	06/09-CH:6R-AU00000	<b>80851</b>	<>	565	 	6R0611701A
----	---------------------	--------------	----	-----	--	------------

TT	CH:6R-AU000 001-	<b>80948</b>	<>	555	 	6R0611701B
----	------------------	--------------	----	-----	--	------------

## TUBI FLESSIBILI PER FRENO

**L**

**o.e.**

### segue POLO V (6R) (06/09->)

TT	06/09-	<b>8903</b>	<>	165	 <b>FB49</b> <b>FB49</b>	6Q0611775B
----	--------	-------------	----	-----	-----------------------------	------------

### POLO CLASSIC (6KV2), POLO VARIANT (6KV5)

TT	11/95-09/01	<b>8551</b>	<>	485	 <b>F</b> <b>MCL</b>	1H0611701
----	-------------	-------------	----	-----	-------------------------	-----------

TT	11/95-09/01	<b>8967</b>	<>	165	 <b>FB54</b> <b>FB54</b>	6N0611775A
----	-------------	-------------	----	-----	-----------------------------	------------

### SCIROCCO (53)

TT (Pinza ATE)	02/74-07/80	<b>8234</b>	<>	326	 <b>F</b> <b>MC11</b>	171611701B
----------------	-------------	-------------	----	-----	--------------------------	------------

TT (Pinza Lucas)	02/74-07/80	<b>8248</b>	<>	306	 <b>F</b> <b>MC11/S</b>	171611701D
------------------	-------------	-------------	----	-----	----------------------------	------------

TT	02/74-07/80	<b>8229</b>	<>	160	 <b>F</b> <b>F</b>	171611775A
----	-------------	-------------	----	-----	-----------------------	------------

### SCIROCCO (53B)

TT (Pinza ATE)	08/80-07/92	<b>8228</b>	<>	310	 <b>F</b> <b>MC11</b>	171611701G
----------------	-------------	-------------	----	-----	--------------------------	------------

TT (Pinza Lucas)	08/80-07/92	<b>8249</b>	<>	266	 <b>F</b> <b>MC11/S</b>	171611701K
------------------	-------------	-------------	----	-----	----------------------------	------------

TT	08/80-07/92	<b>8229</b>	<>	160	 <b>F</b> <b>F</b>	171611775A
----	-------------	-------------	----	-----	-----------------------	------------

### SCIROCCO (137)

TT	09/08-	<b>80160</b>	<>	595	 <b>FB62</b> <b>OR22</b>	1K0611701K
----	--------	--------------	----	-----	-----------------------------	------------

## TUBI FLESSIBILI PER FRENO





L



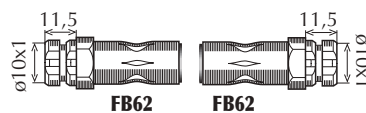

o.e.

### segue SCIROCCO (137)

TT		<b>81020</b>	<>		525	 <p>FB62 FB62</p>	1K0611701L
TT	09/08-10/09	<b>80892</b>	<>		265	 <p>FB62 FB62</p>	1Q0611775A
TT	11/09-	<b>80852</b>	<		270	 <p>FB62 OR22</p>	1K0611775D

### SHARAN

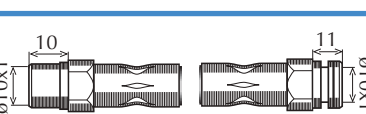
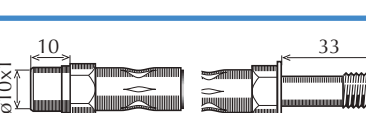
TT	04/96-03/00	<b>8924</b>	<>		500	 <p>FB54 MCL</p>	7M0611701D
TT	04/00-	<b>80258</b>	<>		480	 <p>F5 FB54</p>	7M3611701B
TT	04/96-	<b>80244</b>	<>		400	 <p>F FB54</p>	7M0611775E
TT (alla pinza)	04/96-	<b>8925</b>	<>		185	 <p>F MCL</p>	7M0611776B/C

### SHARAN (Mod. 2010)

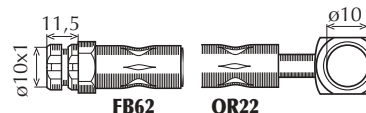
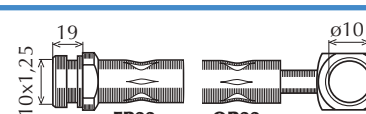
TT	08/10-	<b>81014</b>	<>		570	 <p>FB62 OR22</p>	7N0611701
TT	08/10-	<b>80894</b>	<>		270	 <p>FB22 OR22</p>	5N0611775

### TIGUAN

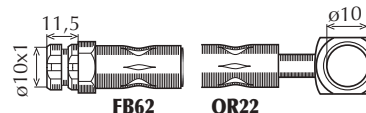
TT	09/07-	<b>80893</b>	<>		585	 <p>FB62 OR22</p>	5N0611701
----	--------	--------------	----	--	-----	---	-----------

## TUBI FLESSIBILI PER FRENO



L



o.e.

### segue TIGUAN

TT	09/07-	80894	<>	270		5N0611775
----	--------	-------	----	-----	--	-----------

### TOUAREG

TT (Ruote 16") (Ate)	11/02-	80544	<>	735		7L6611701A-B
TT (Ruote 17"-18") (Brembo)	11/02-	80169	<>	542		7L0611701A
TT (Ruote 16") (Ate)	11/02-	80594	<>	445		7L6611776-A
TT (Ruote 17"-18") (Brembo)	11/02-	80170	<>	426		7L0611776

### TOURAN

TT	02/03-	80160	<>	595		1K0611701B
TT		81020	<>	525		1K0611701L
TT	02/03-10/09	80161	<>	257		1T0611775A
TT	11/09-	80852	<>	270		1K0611775D

### UP

TT	12/11-	81058	<>	525		1S0611701
----	--------	-------	----	-----	--	-----------

Legenda/Legend: ○ = Intermedio/Intermediate - ● = Interno/Inner - ▲ = Superiore/Upper - ▼ = Inferiore/Lower

## TUBI FLESSIBILI PER FRENO



L





o.e.

### segue UP

TT	12/11-	<b>81059</b>	<>	175		1S0611775
----	--------	--------------	----	-----	--	-----------

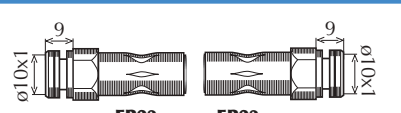
### VENTO



TT	10/91-08/97	<b>8551</b>	<>	485		1H0611701
TT	10/91-08/97	<b>8643</b>	<>	160		1H0611775
1.6 (101 CV), 1.8, 2.0, 2.8 VR6, 1.9 TDI	10/91-08/97	<b>8036</b>	<>	187		481611775

### VOLKSWAGEN COMMERCIALI

#### CADDY I

TT	08/82-07/92	<b>8228</b>	<>	310		171611701G
----	-------------	-------------	----	-----	--	------------

#### CADDY II

TT	11/95-	<b>8551</b>	<>	485		1H0611701
TT	11/95-	<b>8969</b>	<>	430		6K9611776

#### CADDY III

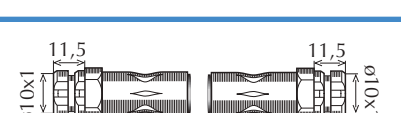
TT	03/04-	<b>80160</b>	<>	595		1K0611701B
TT		<b>81020</b>	<>	525		1K0611701L



## TUBI FLESSIBILI PER FRENO



o.e.

### segue CADDY III

TT (interno)	03/04-	<b>80162</b>	<>	527		2K0611775C
TT	03/04-	<b>80161</b>	<>	257		1K0611775C

### CRAFTER

TT	06/06-	<b>80245</b>	<>	438		2E0611707A
TT	06/06-	<b>80245</b>	<>	438		2E0611707A

### LT I

28-31-35	04/75-06/96	<b>80255</b>	<>	331		281611775B
40-45	08/78-06/96	<b>8256</b>	<>	440		251611775B
50/55	12/82-06/96	<b>8256</b>	<>	440		251611775B
28-31-35 (-> CH:-28D007273)	4/75-6/96	<b>80625</b>	<>	390		281611771
28-31-35 (CH: 28D007274->)	4/75-6/96	<b>8232</b>	<>	390		431611707
40-45 (-> CH:-28D007273)	8/78-6/96	<b>80625</b>	<>	390		281611771
40-45 (CH: 28D007274->)	8/78-6/96	<b>8232</b>	<>	390		431611707

Legenda/Legend: ○ = Intermedio/Intermediate - ● = Interno/Inner - ▲ = Superiore/Upper - ▼ = Inferiore/Lower

## TUBI FLESSIBILI PER FRENO



L





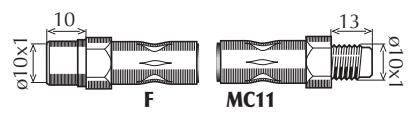

o.e.

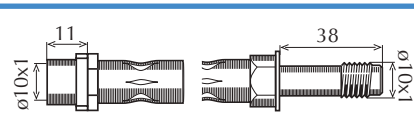
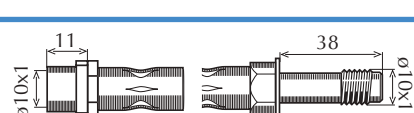

### segue LT I

50/55	12/82-6/96	<b>8232</b>	<>	390		431611707
-------	------------	-------------	----	-----	--	-----------

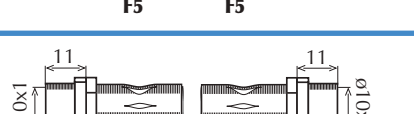
### LT II

TT (- ABS)	5/96-	<b>80235</b>	<>	535		9014289135
TT (+ ABS)	5/96-	<b>8931</b>	<>	410		2D0611701B
TT (- ABS)	5/96-	<b>80245</b>	<>	438		9014280835
28-35 (+ ABS)	5/96-	<b>8931</b>	<>	410		2D0611701B
46 (+ ABS) (centrale)	5/96-	<b>80242</b>	<>	390		9044280535
46 (+ ABS) (alla pinza)	5/96-	<b>80249</b>	<>	265		2D0611775A

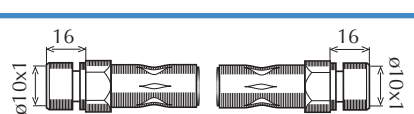
### TRANSPORTER T2

TT	08/67-09/79	<b>8241</b>	<>	300		211611775A
TT	08/67-09/79	<b>8240</b>	▼	236		211611775B
TT	08/67-09/79	<b>8049</b>	▲	280		211611775C

## TUBI FLESSIBILI PER FRENO



L



o.e.

### TRANSPORTER T3

TT	10/79-07/92	8256	<>		440		251611775B
TT	10/79-07/92	8229	<>		160		171611775

### TRANSPORTER T4

TT (- CH: 70T200000)	07/90-12/95	8057	<>		358		701611701
TT ( CH: 70T200001 -)	01/96-04/97	8972	<>		375		7D0611701C
TT	05/97-04/98	8971	>		375		7D0611702
TT	05/97-04/98	8972	<		375		7D0611701C
TT (Ruote 15")	05/98-04/03	8972	>		375		7D0611701C
TT (Ruote 15")	05/98-04/03	8974	<		370		7D0611701B
TT (Ruote 16")	05/98-04/03	8971	>		375		7D0611702
TT (Ruote 16")	05/98-04/03	8972	<		350		7D0611701C
TT	07/90-04/03	8229	<>		160		171611775

Legenda/Legend: ○ = Intermedio/Intermediate - ● = Interno/Inner - ▲ = Superiore/Upper - ▼ = Inferiore/Lower

## TUBI FLESSIBILI PER FRENO



L





o.e.

### segue TRANSPORTER T4

TT (alla pinza)	01/96-04/03	<b>8229</b>	<>	160		171611775
-----------------	-------------	-------------	----	-----	--	-----------

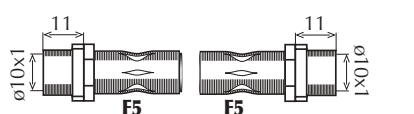
### TRANSPORTER T5 (04/03-11/09)

TT	04/03-11/09	<b>80167</b>	<>	558		7H0611701B
TT (intermedio)	04/03-11/09	<b>80168</b>	<>	275		7H0611775
TT	04/03-11/09	<b>80228</b>	<>	240		7H0611776

### TRANSPORTER T5 (09/09-)

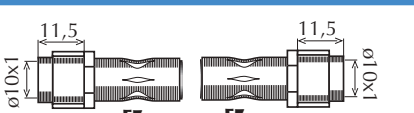
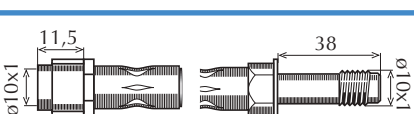
TT	09/09-	<b>80895</b>	<>	565		7H0611701D
TT (intermedio)	09/09-	<b>80896</b>	<>	275		7H0611775B
TT	09/09-	<b>81022</b>	<>	245		7H0611776C

## TUBI FLESSIBILI PER FRENO



L



o.e.

### 240, 260

TT	82-08/91	<b>8243</b>	<>		290			1229348
TT	82-08/91	<b>8457</b>	<>		300			1329594

### 340, 360

TT	08/79-07/91	<b>8502</b>	<>		315			32049900
TT	08/79-07/91	<b>8242</b>	<>		240			3268705

### 440, 460



TT	88-98	<b>8015</b>	<>		490			3447432
TT / Freno a tamburo (- ABS)	88-98	<b>8233</b>	<>		360			3430408
TT / Freno a Disco (- ABS)	88-98	<b>8172</b>	<>		320			3446569
1.6 (+ ABS)	88-08/92	<b>8172</b>	<>		320			3446569
TT (+ ABS)	09/92-98	<b>8634</b>	<>		310			3412685

Legenda/Legend: ○= Intermedio/Intermediate - ●= Interno/Inner - ▲= Superiore/Upper - ▼= Inferiore/Lower



# TUBI FLESSIBILI PER FRENO

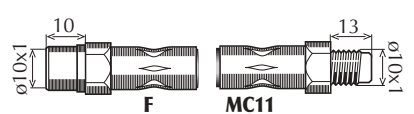
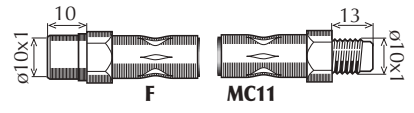

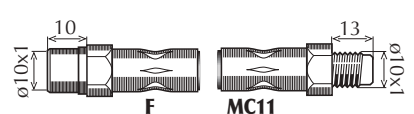

## 480

1.7, 1.7 Turbo, 2.0	04/86-07/96	<b>8015</b>	<>		490		3447432
TT ->CH:522771	08/87-01/88	<b>8634</b>	<>		310		3412685
TT CH:522772->	88-08/92	<b>8172</b>	<>		320		3446569

## 740, 760

TT	82-08/91	<b>8244</b>	<>		370		1329611
TT	82-08/91	<b>8457</b>	<>		300		1329594

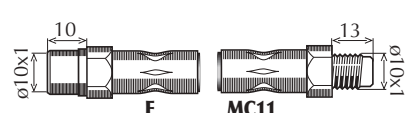
## 850

TT	06/91-12/96	<b>8692</b>	<>		360		3546813
TT	06/91-12/96	<b>8693</b>	<>		225		3516568

## 940, 960

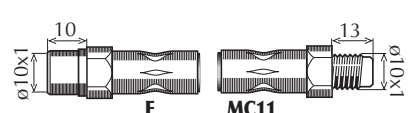
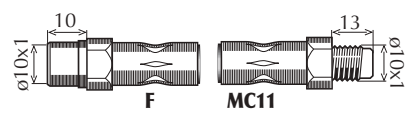
TT	08/90-10/98	<b>8692</b>	<>		360		3546813
TT	08/90-10/98	<b>8457</b>	<>		300		1329594

## TUBI FLESSIBILI PER FRENO



L



o.e.

### C30

TT (ruote 15"-16")	10/06-	<b>80897</b>	<>		440		30681723
TT (ruote 17")	10/06-	<b>80947</b>	<>		440		30681724
TT	10/06-	<b>80898</b>	<>		410		30681726

### C70

TT	03/97-09/02	<b>8692</b>	<>		360		3546813
TT (Ruote 16")	03/97-09/02	<b>80301</b>	<>		385		9191400
TT (interno)	03/97-09/02	<b>8693</b>	<>		225		3516568
TT (esterno)	03/97-09/02	<b>80241</b>	<>		205		9492354
TT (alla pinza)	03/97-09/02	<b>80289</b>	<>		300		9209896



### S40 I

TT	07/95-12/03	<b>8694</b>	<>		474		30870880
TT	07/95-12/03	<b>80626</b>			425		30862413

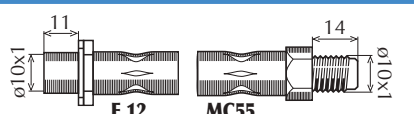
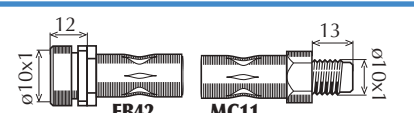

**TUBI FLESSIBILI PER FRENO**

**L**

**o.e.**
**S40 II**

TT (ruote 15"-16")	04/04-	<b>80897</b>	<>		440		30681723
TT (ruote 17")	04/04-	<b>80947</b>	<>		440		30681724
TT	04/04-CH:2553	<b>80216</b>	<>		420		30683332
TT	CH:2554-	<b>80898</b>	<>		410		30681726

**S60**

TT	11/00-	<b>80215</b>	<>		366		9169140
TT	11/00-	<b>80217</b>	<>		293		9485452

**S60 II**

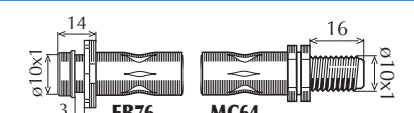
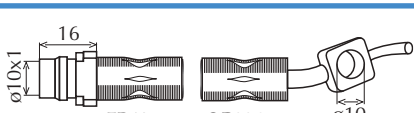
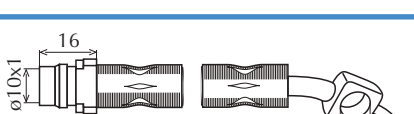
TT	04/10-	<b>80899</b>	<>		420		31305075
TT	04/10-	<b>80709</b>	<		340		31317431
TT	04/10-	<b>80710</b>	>		340		31317430

**S70**

TT	11/96-11/00	<b>8692</b>	<>		360		3546813
----	-------------	-------------	----	--	-----	--	---------



## TUBI FLESSIBILI PER FRENO

**L**

**o.e.**

### segue S70

TT (Ruote 16")	11/96-11/00	<b>80301</b>	<>		385		9191400
TT (interno)	11/96-11/00	<b>8693</b>	<>		225		3516568
TT (esterno)	11/96-11/00	<b>80241</b>	<>		205		9492354
TT (alla pinza)	11/96-11/00	<b>80289</b>	<>		300		9209896

### S80

TT (ruote 15"-16")	10/98-	<b>80215</b>	<>		366		9169140
TT (ruote 17")	03/00-	<b>80711</b>	<>		395		31257706
TT	10/98-	<b>80217</b>	<>		293		9485452

### S80 II

TT (Disco d.300)	03/06-	<b>80899</b>	<>		420		31305075
TT (Disco d.316/336)	03/06-	<b>80713</b>	<>		435		30793631
TT (Freno a mano elettronico)	03/06-	<b>80709</b>	<		340		31305096
TT (Freno a mano elettronico)	03/06-	<b>80715</b>	>		340		31261708

Legenda/Legend: ○ = Intermedio/Intermediate - ● = Interno/Inner - ▲ = Superiore/Upper - ▼ = Inferiore/Lower

# TUBI FLESSIBILI PER FRENO



## segue S80 II

TT	03/06-	<b>80946</b>	<>	215		31261882
----	--------	--------------	----	-----	--	----------

## V40

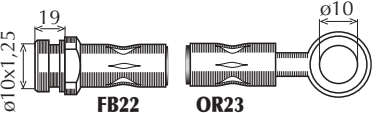
TT	07/95-06/04	<b>8694</b>	<>	474		30870880
----	-------------	-------------	----	-----	--	----------

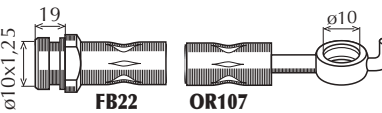
TT	07/95-06/04	<b>80626</b>		425		30862413
----	-------------	--------------	--	-----	--	----------

## V50

TT (ruote 15"-16")	04/04-	<b>80897</b>	<>	440		30681723
--------------------	--------	--------------	----	-----	---	----------

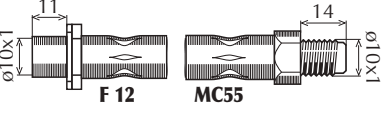
TT (ruote 17")	04/04-	<b>80947</b>	<>	440		30681724
----------------	--------	--------------	----	-----	--	----------

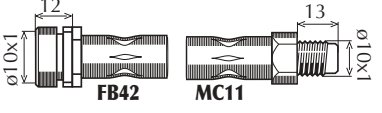
TT	04/04-CH:2553	<b>80216</b>	<>	420		30683332
----	---------------	--------------	----	-----	--	----------

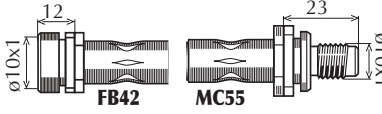
TT	CH:2554-	<b>80898</b>	<>	410		30681726
----	----------	--------------	----	-----	--	----------

## V60

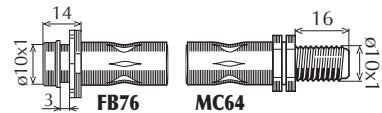
TT	09/10-	<b>80899</b>	<>	420		31305075
----	--------	--------------	----	-----	--	----------

TT	09/10-	<b>80709</b>	<	340		31317431
----	--------	--------------	---	-----	--	----------

TT	09/10-	<b>80710</b>	>	340		31317430
----	--------	--------------	---	-----	--	----------

## TUBI FLESSIBILI PER FRENO



L



o.e.

### V70 I

TT	01/97-05/00	<b>8692</b>	<>		360		3546813
TT (Ruote 16")	01/97-05/00	<b>80301</b>	<>		385		9191400
TT (interno)	01/97-05/00	<b>8693</b>	<>		225		3516568
TT (esterno)	01/97-05/00	<b>80241</b>	<>		205		9492354
TT (alla pinza)	01/97-05/00	<b>80289</b>	<>		300		9209896

### V70 II

TT	03/00-	<b>80215</b>	<>		366		9169140
TT (Ruote 16")	03/00-	<b>80301</b>	<>		385		9191400
TT	03/00-	<b>80217</b>	<>		293		9485452
TT (esterno)	03/00-	<b>80241</b>	<>		205		9492354
TT (alla pinza)	03/00-	<b>80289</b>	<>		300		9209896

### V70 III

TT (Disco d.300)	08/07-	<b>80899</b>	<>		420		31305075
------------------	--------	--------------	----	--	-----	--	----------

Legenda/Legend: ○ = Intermedio/Intermediate - ● = Interno/Inner - ▲ = Superiore/Upper - ▼ = Inferiore/Lower

# TUBI FLESSIBILI PER FRENO





L



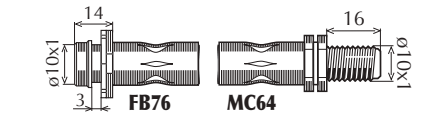

o.e.

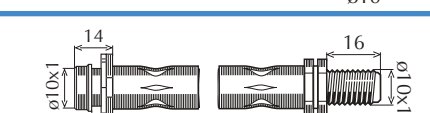
## segue V70 III

TT (Disco d.316/336)	08/07-	<b>80713</b>	<>		435		30793631
TT (Freno a mano elettronico)	08/07-	<b>80709</b>		<	340		31305096
TT (Freno a mano elettronico)	08/07-	<b>80715</b>		>	340		31261708
TT	08/07-	<b>80946</b>		<>	215		31261882

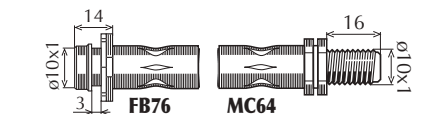
## XC60

TT	05/08-	<b>80708</b>	<>		455		31305080
TT	05/08-	<b>80709</b>		<	340		31317431
TT	05/08-	<b>80710</b>		>	340		31317430

## XC70 I

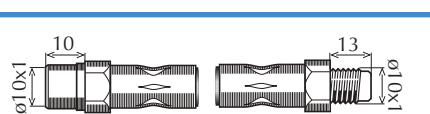
TT	03/00-	<b>80711</b>	<>		395		31257706
TT	03/00-	<b>80217</b>		<>	293		9485452

## XC70 II

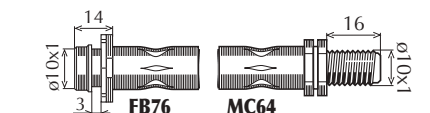
TT (Disco d.300)	08/07-	<b>80899</b>	<>		420		31305075
------------------	--------	--------------	----	--	-----	--	----------

## TUBI FLESSIBILI PER FRENO



L



o.e.

### segue XC70 II

TT (Disco d.316/336)	08/07-	<b>80713</b>	< >		435		30793631
TT (Freno a mano elettronico)	08/07-	<b>80709</b>	<				31305096
TT (Freno a mano elettronico)	08/07-	<b>80715</b>	>				31261708
TT	08/07-	<b>80946</b>	< >		215		31261882

### XC90

TT	10/02-	<b>80716</b>	< >		415		31257707
TT	10/02-	<b>80717</b>	< >		295		31257711

**TUBI FLESSIBILI PER FRENO**

**L**

**o.e.**
**101**

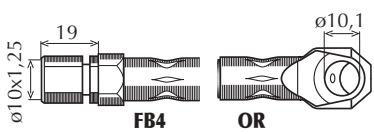
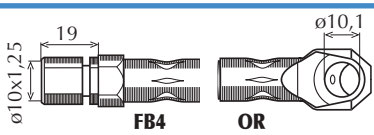
1.1	75-93	<b>8266</b>	<>		300		4253987
1.1	75-93	<b>8269</b>	<>		265		4256246

**YUGO**

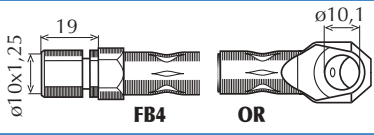
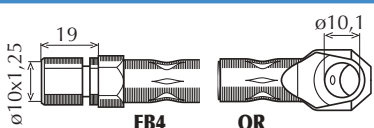
TT		<b>8266</b>	<>		300		4253987
TT		<b>8269</b>	<>		265		4256246





# Tubi flessibili per Freno e Frizione

Catalogo

01  
13

Tubi flessibili per frizione







L

O.E.



## ALFA ROMEO

### 33

#### -1989

TT (- Super)	->89	<b>8378</b>	392	60502667	
Super	->89	<b>8441</b>	530	60501245	

#### 1990-12/93

TT Resty.	90->12/93	<b>8441</b>	530	60501245	
-----------	-----------	-------------	-----	----------	--

### 75

TT	05/85->02/92	<b>8151</b>	305	60500444	
----	--------------	-------------	-----	----------	--

### 90

TT		<b>8151</b>	305	60500444	
----	--	-------------	-----	----------	--

### 145

#### 09/94-12/96

TT (- 2.0 TS) (I Tratto)	9/94-12/96	<b>8977</b>	605	60606168	
TT (- 2.0 TS) (II Tratto)	9/94-12/96	<b>8399</b>	215	82409618	
2.0 TS	9/94-12/97	<b>8978</b>		60614861	

#### 01/97-01/01

TT/Benzina	01/97->	<b>8975</b>		60658944	
1.9 TD	01/97->	<b>8490</b>	300	60602274	
1.9 JTD		<b>8976</b>		46534942	

### 146

#### 12/94-12/96

TT (I Tratto)	9/94-12/96	<b>8977</b>	605	60606168	
TT (II Tratto)	9/94-12/96	<b>8399</b>	215	82409618	

# TUBI FLESSIBILI PER FRIZIONE



L

O.E.



## segue 146

### 01/97-01/01

TT/Benzina	01/97->	<b>8975</b>		60658944	
1.9 TD	01/97->	<b>8490</b>	300	60602274	
1.9 JTD		<b>8976</b>		46534942	

### 147

TT	01/01->	<b>8981</b>		73503546	
----	---------	-------------	--	----------	--

### 155

TT/BZ	11/91->94	<b>8442</b>	505	60570999	
TT/BZ	95->	<b>8978</b>		60614861	
1.9 TD	11/91->12/97	<b>8490</b>	300	60602274	
2.5 TD	11/91->94	<b>8491</b>	630	60603030	

### 156

TT	10/97->	<b>8979</b>		60652184	
----	---------	-------------	--	----------	--

### 164

TT ( - TD)	06/87->09/98	<b>8438</b>	400	60608470	
2.5 TD	06/87->09/98	<b>8440</b>	325	60622814	
(ABS) II TRATTO	06/87->09/98	<b>8439</b>	390	60608471	

### 166

TT	09/98->	<b>8980</b>	315	60618617	
----	---------	-------------	-----	----------	--

### 2000

TT	01/70->79	<b>8151</b>	305	60570999	
----	-----------	-------------	-----	----------	--

### ALFETTA

TT	72->86	<b>8151</b>	305	60570999	
----	--------	-------------	-----	----------	--

**L**
**O.E.**

**GIULIETTA**

TT	77->86	<b>8151</b>	305	60570999	
----	--------	-------------	-----	----------	--

**GTV (Mod. 95)**

2.0 TS	95->	<b>8978</b>		60614861	
--------	------	-------------	--	----------	--

**SPIDER (Mod. 95)**

2.0 TS	09/94->	<b>8978</b>		60614861	
--------	---------	-------------	--	----------	--

**AUDI**
**A3**

TT ( - 1.6)	09/96->	<b>8990</b>		1J1721465M	
-------------	---------	-------------	--	------------	--

TT	01/95->	<b>8989</b>		8D1721465	
----	---------	-------------	--	-----------	--

**FIAT**
**1300 - 1500**

TT		<b>8056</b>	280	4087204	
----	--	-------------	-----	---------	--

**1800 B - 2300**

TT		<b>8150</b>	318	4170091	
----	--	-------------	-----	---------	--

**CROMA**

2.0 ie, 2.0 Turbo, 2.5 V6, 1.9 TD id, 2.4 TD (Cat.)	04/88->12/96	<b>8471</b>	405	824470774	
---	--------------	-------------	-----	-----------	--

1.9 TD id, 2.4 TD	04/88->12/96	<b>8412</b>	400	824444203	
-------------------	--------------	-------------	-----	-----------	--

**DOBLO'**

1.6, 1.9 D, 1.9 JTD	01->	<b>8985</b>		46745159	
---------------------	------	-------------	--	----------	--

**MAREA**

2.0 20V, 1.9 JTD, 2.4 TD, 2.4 JTD	07/96->	<b>8982</b>		46442449	
-----------------------------------	---------	-------------	--	----------	--

**PUNTO II SERIE**

1.2 8V, 1.8 16V	09/99->	<b>8983</b>		46764303	
-----------------	---------	-------------	--	----------	--

# TUBI FLESSIBILI PER FRIZIONE



L

O.E.



## segue PUNTO II SERIE

1.2 16V	09/99->	<b>8997</b>	645	46541771	
1.9 D, 1.9 JTD	09/99->	<b>8984</b>		46749648	

## FIAT COMMERCIALI 238 (Circuito Semplice)

238		<b>8135</b>	235	4134496	Circuito semplice
-----	--	-------------	-----	---------	-------------------

## 241

241 TN		<b>8134</b>	450	4175681	
--------	--	-------------	-----	---------	--

## FIAT VEICOLI INDUSTRIALI 130NC

130 NC		<b>8139</b>	390	4590158	
--------	--	-------------	-----	---------	--

## 615N,N1 - 616N,N1,N2,N2/4,N3 625N,N1,N2,N3

615 N/N1, 616 N/N1		<b>8045</b>	335	4035953	
TT (-615 N/N1, 616 N/N1)		<b>8077</b>	340	4088935	

## 645N,N1,N2,N3 - 650N,N1,N2,N3 - 650E,E1 - 655N,N1 - 662N,N1,N2,N3 - 672N - 673N

TT (-650 E,662 N)		<b>8139</b>	390	4590158	
-------------------	--	-------------	-----	---------	--

## INNOCENTI MINI 90 - 120

90, 120, L, De Tomaso	74->	<b>8132</b>	194	38822112	
-----------------------	------	-------------	-----	----------	--

## MINI TRE

3 Cil./TT	87-	<b>8132</b>	194	38822112	
-----------	-----	-------------	-----	----------	--

## MINI MINOR

850, 1.0 MK2, MK3, Clubman, Cooper		<b>8132</b>	194	38822112	
------------------------------------	--	-------------	-----	----------	--

**L**
**O.E.**

**IVECO / OM**
**40 NC - 40/35 NC - 50 NC - 55 NC - 80 NC - 90 NC**

40 NC - 40/35 NC		<b>8077</b>	340	4088935	
50 NC - 55 NC		<b>8287</b>	405	8556396	
80 NC - 90 NC -CH:5287		<b>8295</b>	410	8788688	
80 NC - 90 NC CH:5288-		<b>8287</b>	405	8556396	

**50.8,50 F8,50.9,50 F9,50.10,55.8,55 F8,55.9,55.10,55 F10,60.8,60.10,65.10,65 F10,70.10,70.10/1,70.12,75.10,79.10**

50.8,50/55/60 F8/9/10,65.10,70.10,65/70/75/79 F10		<b>8337</b>	365	8790849	
50.10, 60.10, 79.10		<b>8368</b>	442	8794780	

**79.13 - 80.13 - 90.13 - 90 F13 - 100.13 - 100 F13**

TT		<b>8337</b>	365	8790849	
----	--	-------------	-----	---------	--

**79.14 - 79.14 Zeta - 95.14 - 95.14 Zeta - 109.14 - 109.14 Zeta**

TT		<b>8337</b>	365	8790849	
----	--	-------------	-----	---------	--

**100 NC - 110 NC, NR, NT, PC,PC/M, AL - 110.14**

TT		<b>8139</b>	390	4590158	
----	--	-------------	-----	---------	--

**330 F26 - 330 F35**

TT		<b>8347</b>	300	4463200	
----	--	-------------	-----	---------	--

**OM 50 - 55 - 65 - 60/65 - 70 - 75 - 80 - 90**

OM 50 - 55		<b>8287</b>	405	8556396	
OM 80 - 90		<b>8297</b>	300	8556043	

**OM 100 - 100 N - 110 - 120 - 130**

OM 100 - OM 110 - OM 130		<b>8139</b>	390	4590158	
OM 100 N		<b>8287</b>	405	8556396	

# TUBI FLESSIBILI PER FRIZIONE



L

O.E.



## OM Orsetto

Orsetto		<b>8077</b>	340	4088935	
---------	--	-------------	-----	---------	--

## OM Tigrotto

Tigrotto		<b>8077</b>	340	4088935	
----------	--	-------------	-----	---------	--

## LADA

**1200, 1300, 1500, 1600 (2101, 2102, 2103)**

TT	07/99->	<b>8012</b>	280	2101-1602590	
----	---------	-------------	-----	--------------	--

## NOVA (2104, 2105)

TT	07/99->	<b>8012</b>	280	2101-1602590	
----	---------	-------------	-----	--------------	--

## LANCIA - AUTOBIANCHI

### LYBRA

TT (I Tratto)	07/99->	<b>8986</b>		46548236	
---------------	---------	-------------	--	----------	--

TT/BZ (- 2.4 20V) (II Tratto)	07/99->	<b>8987</b>		73503190	
-------------------------------	---------	-------------	--	----------	--

TT/DS (II Tratto)	07/99->	<b>8979</b>		60652184	
-------------------	---------	-------------	--	----------	--

## THEMA

**09/92-07/94**

TT	07/84->07/94	<b>8412</b>	400	82444203	
----	--------------	-------------	-----	----------	--

## ROVER GROUP

### MINI

MINI MINOR/TT		<b>8132</b>	194		
---------------	--	-------------	-----	--	--

## VOLKSWAGEN

### BORA

TT (- 1.6)	09/96-	<b>8990</b>		1J1721465M	
------------	--------	-------------	--	------------	--

### GOLF IV

TT (- 1.6)	08/97-	<b>8990</b>		1J1721465M	
------------	--------	-------------	--	------------	--



# Tubi flessibili per Freno e Frizione

Catalogo

01  
13

Illustrazioni e componenti  
tubi freno





**Figura 1**



**BM1**

**FP3**



Lunghezza/Lenght

**AKRON**

Accessori/Features

426

**8601**

(1)C16-(1)C42

**Figura 2**



**BM2**

**FP3**



Lunghezza/Lenght

**AKRON**

Accessori/Features

426

**8602**

(1)C16-(1)C43

**Figura 3**



**EF259**

**EF260**

Lunghezza/Lenght

**AKRON**

Accessori/Features

275

**8468**

-

**Figura 4**



**EF259**

**EF261**

Lunghezza/Lenght

**AKRON**

Accessori/Features

275

**8469**

-

**Figura 5**



**EF259**

**EF262**

Lunghezza/Lenght

**AKRON**

Accessori/Features

275

**8466**

-

278

**8397**

-

**Figura 6**



**EF259**

**EF263**

Lunghezza/Lenght

**AKRON**

Accessori/Features

275

**8467**

-

278

**8398**

-

**Figura 7**



**EF259**

**EF296**

Lunghezza/Lenght

**AKRON**

Accessori/Features

275

**8402**

-

**Figura 8**



**EF264**

**EF265**

Lunghezza/Lenght

**AKRON**

Accessori/Features

430

**8464**

(1)C44

**Tubi flessibili per freno**  
**suddivisi per tipo ed elencati**  
**in ordine progressivo dimensionale**

**Figura 9**



**EF266**

**EF267**



Lunghezza/Lenght	AKRON	Accessori/Features
430	8465	(1)C45

**Figura 10**



**EF296**

**FC4**



Lunghezza/Lenght	AKRON	Accessori/Features
430	8698	-

**Figura 11**



**EF297/EF298**

**ST10**



Lunghezza/Lenght	AKRON	Accessori/Features
440	8699	(1)C83-(1)C14

**Figura 12**



**EF297**

**FC3**



Lunghezza/Lenght	AKRON	Accessori/Features
420	8691	-

**Figura 13**



**EF299**

**OR41**



Lunghezza/Lenght	AKRON	Accessori/Features
430	80084	-

**Figura 14**



**EF300**

**OR31**

Lunghezza/Lenght	AKRON	Accessori/Features
515	80695	(1)C71-(1)C112

**Figura 15**



**EF300**

**OR33**

Lunghezza/Lenght	AKRON	Accessori/Features
737	8951	(2)C53-(2)C3

**Figura 16**



**EF301**

**OR56**

Lunghezza/Lenght	AKRON	Accessori/Features
400	80152	(1)C25

**Figura 17**



**EF301**

**OR57**

Lunghezza/Lenght	AKRON	Accessori/Features
400	80153	(1)C25

**Figura 18**



<b>EF302</b>		<b>OR41</b>
Lunghezza/Lenght	AKRON	Accessori/Features
345	80085	-

**Figura 19**



<b>EF304</b>		<b>OR33</b>
Lunghezza/Lenght	AKRON	Accessori/Features
760	80602	(2)C53-(3)C3

**Figura 20**



<b>EF305</b>		<b>OR33</b>
Lunghezza/Lenght	AKRON	Accessori/Features
760	80601	(2)C53-(3)C3

**Figura 21**



<b>EF306</b>		<b>OR208</b>
Lunghezza/Lenght	AKRON	Accessori/Features
545	80789	(1)C124-(1)C27

**Figura 22**



<b>EF306</b>		<b>OR251</b>
Lunghezza/Lenght	AKRON	Accessori/Features
535	80771	(1)C124-(1)C27

**Figura 23**



<b>EF307</b>		<b>OR205</b>
Lunghezza/Lenght	AKRON	Accessori/Features
545	80788	(1)C124-(1)C27

**Figura 24**



<b>EF307</b>		<b>OR247</b>
Lunghezza/Lenght	AKRON	Accessori/Features
535	80770	(1)C124-(1)C27

**Figura 25**



<b>EF309</b>		<b>OR200</b>
Lunghezza/Lenght	AKRON	Accessori/Features
345	81042	-

**Figura 26**



<b>EF309</b>		<b>OR249</b>
Lunghezza/Lenght	AKRON	Accessori/Features
375	80777	-

**Figura 27**



<b>EF310</b>		<b>OR245</b>
Lunghezza/Lenght	AKRON	Accessori/Features
410	80672	-

**Tubi flessibili per freno**  
**suddivisi per tipo ed elencati**  
**in ordine progressivo dimensionale**

**Figura 28**



	<b>EF311</b>	<b>OR199</b>
Lunghezza/Lenght	AKRON	Accessori/Features
345	<b>81041</b>	-

**Figura 29**



	<b>EF311</b>	<b>OR249</b>
Lunghezza/Lenght	AKRON	Accessori/Features
375	<b>80776</b>	-

**Figura 30**



	<b>EF312</b>	<b>OR31</b>
Lunghezza/Lenght	AKRON	Accessori/Features
700	<b>80674</b>	(1)C130-(1)C128-(1)C27-(1)C17
700	<b>80675</b>	(1)C139-(1)C150-(1)C27-(1)C17
700	<b>80917</b>	-
700	<b>80918</b>	(1)C130-(1)C128-(1)C25-(1)C17

**Figura 31**



	<b>EF313</b>	<b>OR244</b>
Lunghezza/Lenght	AKRON	Accessori/Features
410	<b>80673</b>	-

**Figura 32**



	<b>EF314</b>	<b>OR33</b>
Lunghezza/Lenght	AKRON	Accessori/Features
555	<b>80774</b>	(1)C133
555	<b>80775</b>	(1)C136

**Figura 33**



	<b>EF315</b>	<b>OR33</b>
Lunghezza/Lenght	AKRON	Accessori/Features
390	<b>80671</b>	(1)C25

**Figura 34**



	<b>EF316</b>	<b>OR203</b>
Lunghezza/Lenght	AKRON	Accessori/Features
255	<b>80676</b>	(1)C26
255	<b>80677</b>	(1)C26



**Figura 35**



	<b>EF317</b>	<b>OR33</b>
Lunghezza/Lenght	AKRON	Accessori/Features
390	<b>80670</b>	(1)C25

**Figura 36**



	<b>F</b>	<b>F</b>	
Lunghezza/Lenght	AKRON	Accessori/Features	
125	<b>80238</b>	-	
160	<b>8229</b>	-	
175	<b>8041</b>	-	
180	<b>8227</b>	(1)C3	
200	<b>8230</b>	(1)C24	
205	<b>80241</b>	-	
225	<b>8693</b>	-	
240	<b>8242</b>	-	
265	<b>8254</b>	-	
290	<b>8243</b>	-	
315	<b>8695</b>	-	
342	<b>8423</b>	(1)C14	
440	<b>8256</b>	(3)C18	
495	<b>8013</b>	-	

**Figura 37**



<b>F</b>		<b>F6</b>	
Lunghezza/Lenght	AKRON	Accessori/Features	
223	<b>8908</b>	-	

**Figura 38**



<b>F</b>		<b>FB3</b>	
Lunghezza/Lenght	AKRON	Accessori/Features	
250	<b>8247</b>	(1)C18	

**Figura 39**



<b>F</b>		<b>FB54</b>	
Lunghezza/Lenght	AKRON	Accessori/Features	
315	<b>80247</b>	(1)C2	
400	<b>80244</b>	(1)C2-(1)C17	

**Figura 40**



<b>F</b>		<b>MC11</b>	
Lunghezza/Lenght	AKRON	Accessori/Features	
187	<b>8036</b>	-	
205	<b>8906</b>	-	
225	<b>8037</b>	(1)C14	
235	<b>8043</b>	(1)C15-(1)C14-(1)C2	
240	<b>8039</b>	(1)C14	
290	<b>8226</b>	(1)C24	
293	<b>80217</b>	(1)C2	
300	<b>8457</b>	(1)C14	
305	<b>8913</b>	(1)C14-(2)C2	
310	<b>8228</b>	(2)C3	
310	<b>8289</b>	-	
310	<b>8634</b>	(1)C14	
315	<b>8502</b>	(1)C18	
320	<b>8172</b>	-	

**segue Figura 40**

<b>F</b>		<b>MC11</b>	
Lunghezza/Lenght	AKRON	Accessori/Features	
326	<b>8234</b>	-	
360	<b>8233</b>	(2)C24	
360	<b>8692</b>	(2)C2	
365	<b>8370</b>	-	
370	<b>8244</b>	-	
389	<b>8290</b>	-	
390	<b>8232</b>	(2)C24	
420	<b>8458</b>	(1)C8-(1)C1	
486	<b>8480</b>	-	
490	<b>8015</b>	(1)C5	

**Figura 41**



<b>F</b>		<b>MC11/S</b>	
Lunghezza/Lenght	AKRON	Accessori/Features	
266	<b>8249</b>	(2)C24	
306	<b>8248</b>	-	

**Figura 42**



<b>F</b>		<b>MC55</b>	
Lunghezza/Lenght	AKRON	Accessori/Features	
245	<b>80320</b>	(1)C65	
257	<b>80193</b>	-	
280	<b>80317</b>	(1)C14	
295	<b>80712</b>	(1)C2	
295	<b>80717</b>	-	
300	<b>80289</b>	(1)C14-(3)C2	
305	<b>80331</b>	(1)C14	
365	<b>8928</b>	-	
385	<b>80301</b>	(1)C14-(2)C2	
445	<b>8178</b>	-	
525	<b>8930</b>	-	
545	<b>8929</b>	(1)C14-(2)C1	



**Tubi flessibili per freno**  
suddivisi per tipo ed elencati  
in ordine progressivo dimensionale

**Figura 43**



<b>F</b>		<b>MCL</b>	
Lunghezza/Lenght	AKRON	Accessori/Features	
185	<b>8925</b>	-	
325	<b>8912</b>	(1)C14	
360	<b>8644</b>	(1)C2	
366	<b>80215</b>	(1)C2	
395	<b>80711</b>	(1)C2	
415	<b>80716</b>	(1)C15-(2)C3	
485	<b>8551</b>	(2)C2-(1)C4	

**Figura 44**



<b>F</b>		<b>MCL1</b>	
Lunghezza/Lenght	AKRON	Accessori/Features	
330	<b>81029</b>	(1)C16	

**Figura 45**



<b>F2</b>		<b>MC11</b>	
Lunghezza/Lenght	AKRON	Accessori/Features	
333	<b>8330</b>	-	
340	<b>8487</b>	-	

**Figura 46**



<b>F2</b>		<b>MC55</b>	
Lunghezza/Lenght	AKRON	Accessori/Features	
560	<b>80282</b>	(1)C68-(1)C65	

**Figura 47**



<b>F3</b>		<b>F3</b>	
Lunghezza/Lenght	AKRON	Accessori/Features	
260	<b>8511</b>	-	

**Figura 48**



<b>F3</b>		<b>MP19</b>	
Lunghezza/Lenght	AKRON	Accessori/Features	
340	<b>8509</b>	(1)C1	

**Figura 49**



<b>F4</b>		<b>MG5</b>	
Lunghezza/Lenght	AKRON	Accessori/Features	
575	<b>8628</b>	(1)C4-(1)C20-(3)C24	
575	<b>8629</b>	(1)C4-(1)C20-(3)C24	

**Figura 50**



<b>F5</b>		<b>F5</b>	
Lunghezza/Lenght	AKRON	Accessori/Features	
195	<b>8905</b>	-	
205	<b>8061</b>	-	
225	<b>8038</b>	-	
265	<b>80249</b>	-	
275	<b>80168</b>	-	
295	<b>8030</b>	(1)C14	
310	<b>8035</b>	(2)C14	
328	<b>80171</b>	(1)C14-(1)C2	
340	<b>80164</b>	(2)C14	
350	<b>8972</b>	(2)C3-(2)C2	
355	<b>80415</b>	(2)C14-(1)C84	
358	<b>8057</b>	(1)C3-(1)C2	
370	<b>8550</b>	(1)C24	
370	<b>8974</b>	(1)C3-(1)C2-(3)C23	
375	<b>8971</b>	(1)C3-(3)C23	
384	<b>80163</b>	(2)C18-(2)C14	
390	<b>80242</b>	-	

**Figura 51**



	<b>F5</b>	<b>FB54</b>	
Lunghezza/Lenght	AKRON	Accessori/Features	
480	<b>80258</b>	(1)C4-(2)C65	

**Figura 52**



	<b>F5</b>	<b>MC11</b>	
Lunghezza/Lenght	AKRON	Accessori/Features	
228	<b>8062</b>	-	
350	<b>80165</b>	(1)C14-(1)C3	
505	<b>8068</b>	(1)68-(1)C2	

**Figura 53**



	<b>F5</b>	<b>MCL</b>	
Lunghezza/Lenght	AKRON	Accessori/Features	
240	<b>80228</b>	-	
558	<b>80167</b>	(1)C4-(1)C16	

**Figura 54**



	<b>F5</b>	<b>MCL1</b>	
Lunghezza/Lenght	AKRON	Accessori/Features	
410	<b>8931</b>	-	
438	<b>80245</b>	-	
535	<b>80235</b>	-	

**Figura 55**



	<b>F5</b>	<b>OR26</b>	
Lunghezza/Lenght	AKRON	Accessori/Features	
240	<b>8904</b>	-	

**Figura 56**



	<b>F5</b>	<b>OR27</b>	
Lunghezza/Lenght	AKRON	Accessori/Features	
225	<b>8968</b>	-	
330	<b>80248</b>	-	

**Figura 57**



	<b>F6</b>	<b>F6</b>	
Lunghezza/Lenght	AKRON	Accessori/Features	
210	<b>80232</b>	-	

**Figura 58**



	<b>F6</b>	<b>MC11</b>	
Lunghezza/Lenght	AKRON	Accessori/Features	
305	<b>80951</b>	(1)C15-(1)C14	
440	<b>8911</b>	(2)C2	
453	<b>8907</b>	(1)C4	
483	<b>80264</b>	(1)C10-(2)C65	
553	<b>80266</b>	(1)C14-(2)C5	
555	<b>80725</b>	(1)C4	
615	<b>81027</b>	(1)C87-(1)C27-(1)C15-(1)C7	
680	<b>80726</b>	(2)C87	

**Figura 59**



	<b>F6</b>	<b>MC55</b>	
Lunghezza/Lenght	AKRON	Accessori/Features	
235	<b>80729</b>	-	
385	<b>80336</b>	(1)C16	
390	<b>81031</b>	-	
440	<b>80635</b>	(1)C4-(1)C16	
465	<b>80658</b>	(1)C87	
480	<b>80308</b>	(1)C4	





**Tubi flessibili per freno**  
**suddivisi per tipo ed elencati**  
**in ordine progressivo dimensionale**

**segue Figura 59**

	<b>F6</b>	<b>MC55</b>
Lunghezza/Lenght	AKRON	Accessori/Features
510	<b>80994</b>	(1)C68-(2)C2
540	<b>80416</b>	(1)C87
545	<b>80294</b>	(1)C68
545	<b>80305</b>	(1)C68-(1)C65
550	<b>81030</b>	(1)C4
580	<b>80281</b>	(1)C14-(1)C4-(3)C65
585	<b>80656</b>	(1)C14-(1)C7-(2)C5
590	<b>80949</b>	(1)C4
630	<b>80657</b>	(1)C87-(2)C15-(2)C16-(1)C17



**Figura 60**



	<b>F6</b>	<b>MCL</b>
Lunghezza/Lenght	AKRON	Accessori/Features
265	<b>80330</b>	(1)C65
455	<b>8910</b>	(1)C4
500	<b>8909</b>	(1)C32

**Figura 61**



	<b>F7</b>	<b>F7</b>	
Lunghezza/Lenght	AKRON	Accessori/Features	
275	<b>80896</b>	-	
320	<b>80592</b>	(1)C27	
335	<b>81065</b>	-	
375	<b>80253</b>	(1)C14	
426	<b>80170</b>	(1)C63	
542	<b>80169</b>	(1)C27-(2)C8-(1)C4	

**Figura 62**



	<b>F7</b>	<b>MC11</b>
Lunghezza/Lenght	AKRON	Accessori/Features
283	<b>80195</b>	(1)C27
310	<b>8927</b>	(2)C14
315	<b>80236</b>	-

**segue Figura 62**

	<b>F7</b>	<b>MC11</b>
Lunghezza/Lenght	AKRON	Accessori/Features
322	<b>80197</b>	(2)C14
328	<b>80192</b>	-
358	<b>80250</b>	(1)C14
380	<b>80808</b>	(1)C112
380	<b>81001</b>	(1)C25
406	<b>80196</b>	(1)C14-(1)C17
415	<b>8011</b>	-
430	<b>80807</b>	-
485	<b>81000</b>	(2)C27-(1)C12
496	<b>80194</b>	-
515	<b>80809</b>	(1)C27-(1)C10

**Figura 63**



	<b>F7</b>	<b>MC55</b>
Lunghezza/Lenght	AKRON	Accessori/Features
330	<b>80806</b>	(1)C27
575	<b>80998</b>	(1)C4-(1)C16
635	<b>80999</b>	(2)C4

**Figura 64**



	<b>F7</b>	<b>MCL</b>
Lunghezza/Lenght	AKRON	Accessori/Features
445	<b>80655</b>	(1)C107-(3)C2-(3)C16
470	<b>81024</b>	(1)C107-(3)C2-(3)C16
520	<b>80721</b>	(3)C3-(2)C2-(1)C4
535	<b>80654</b>	(3)C3-(2)C2-(1)C4

**Figura 65**



	<b>F7</b>	<b>MCL1</b>
Lunghezza/Lenght	AKRON	Accessori/Features
245	<b>81022</b>	-
550	<b>80251</b>	(1)C4
565	<b>80895</b>	(1)C5-(1)C16
715	<b>81023</b>	(1)C107-(2)C3-(1)C4



**Figura 66**



	<b>F7</b>	<b>MG1</b>	
	Lunghezza/Lenght	AKRON	Accessori/Features
	735	80544	(1)C27-(2)C66-(2)C4

**Figura 67**



	<b>F7</b>	<b>MG9</b>	
	Lunghezza/Lenght	AKRON	Accessori/Features
	590	81064	(1)C25-(1)C18-(1)C5
	730	81028	(1)C27-(1)C66-(1)C14- (1)C4-(1)C62-(1)C10
	740	80950	(1)C25-(1)C15-(1)C62

**Figura 68**



	<b>F7</b>	<b>OR22</b>	
	Lunghezza/Lenght	AKRON	Accessori/Features
	410	8966	(1)C7
	420	80166	(1)C18-(1)C2

**Figura 69**



	<b>F7</b>	<b>OR27</b>	
	Lunghezza/Lenght	AKRON	Accessori/Features
	280	80254	-

**Figura 70**



	<b>F7</b>	<b>OR104</b>	
	Lunghezza/Lenght	AKRON	Accessori/Features
	410	80624	(1)C3-(1)C2



**Figura 71**



	<b>F7</b>	<b>OR125</b>	
	Lunghezza/Lenght	AKRON	Accessori/Features
	445	80594	(1)C63

**Figura 72**



	<b>F8</b>	<b>F8</b>	
	Lunghezza/Lenght	AKRON	Accessori/Features
	207	8935	-
	220	8938	-

**Figura 73**



	<b>F8</b>	<b>MC11</b>	
	Lunghezza/Lenght	AKRON	Accessori/Features
	205	80599	(1)C65
	405	80644	(1)C18-(1)C14-(1)C5

**Figura 74**



	<b>F8</b>	<b>OR30</b>	
	Lunghezza/Lenght	AKRON	Accessori/Features
	224	8936	-
	396	8934	(1)C72-(1)C14
	440	80277	(1)C72-(1)C14

**Figura 75**



	<b>F8</b>	<b>OR50</b>	
	Lunghezza/Lenght	AKRON	Accessori/Features
	310	8937	(1)C14

**Tubi flessibili per freno**  
**suddivisi per tipo ed elencati**  
**in ordine progressivo dimensionale**

**Figura 76**



	<b>F8</b>	<b>OR72</b>	
Lunghezza/Lenght	AKRON	Accessori/Features	
330	80342	-	

**Figura 77**



	<b>F8</b>	<b>OR74</b>	
Lunghezza/Lenght	AKRON	Accessori/Features	
425	8340	(1)C72-(1)C14	

**Figura 78**



	<b>F8</b>	<b>OR254</b>	
Lunghezza/Lenght	AKRON	Accessori/Features	
315	80849	-	
315	80850	-	

**Figura 79**



	<b>F8/1</b>	<b>OR128</b>	
Lunghezza/Lenght	AKRON	Accessori/Features	
330	80584	(1)C14	

**Figura 80**



	<b>F10</b>	<b>OR36</b>	
Lunghezza/Lenght	AKRON	Accessori/Features	
375	80831	(1)C14	
505	80829	(1)C14-(1)C21	

**Figura 81**



	<b>F12</b>	<b>MC55</b>	
Lunghezza/Lenght	AKRON	Accessori/Features	
440	80947	(1)C2-(1)C4-(1)C65	

**Figura 82**



	<b>F12</b>	<b>MCL2</b>	
Lunghezza/Lenght	AKRON	Accessori/Features	
440	80897	(1)C2-(1)C4-(1)C65	

**Figura 83**



	<b>F13</b>	<b>OR30</b>	
Lunghezza/Lenght	AKRON	Accessori/Features	
580	80633	(1)C4	

**Figura 84**



	<b>F13</b>	<b>OR67</b>	
Lunghezza/Lenght	AKRON	Accessori/Features	
445	80634	(1)C4	

**Figura 85**



	<b>F14</b>	<b>OR65</b>	
Lunghezza/Lenght	AKRON	Accessori/Features	
415	80832	(1)C15-(1)C5	

**Figura 86**



**F14**

**OR66**

Lunghezza/Lenght	AKRON	Accessori/Features
490	80830	(1)C15-(1)C21

**Figura 87**



**FA1**

**FA1**

Lunghezza/Lenght	AKRON	Accessori/Features
180	8100	-
270	8097	-

**Figura 88**



**FA1**

**MC11**

Lunghezza/Lenght	AKRON	Accessori/Features
375	8325	-

**Figura 89**



**FA1**

**MP6**

Lunghezza/Lenght	AKRON	Accessori/Features
295	8101	-
405	8102	-

**Figura 90**



**FA1**

**MP12**

Lunghezza/Lenght	AKRON	Accessori/Features
460	8309	-
500	8096	-

**Figura 91**



**FA5**

**OR33**

Lunghezza/Lenght	AKRON	Accessori/Features
490	80056	(1)C51
510	80054	(1)C51-(1)C66

**Figura 92**



**FA5**

**OR40**

Lunghezza/Lenght	AKRON	Accessori/Features
360	80078	-
405	80082	-

**Figura 93**



**FA5**

**OR179**

Lunghezza/Lenght	AKRON	Accessori/Features
650	80932	(1)C75

**Figura 94**



**FA6**

**OR58**

Lunghezza/Lenght	AKRON	Accessori/Features
421	80091	(1)C51

**Figura 95**



**FA6**

**OR99**

Lunghezza/Lenght	AKRON	Accessori/Features
500	80570	(1)C75

**Tubi flessibili per freno**  
**suddivisi per tipo ed elencati**  
**in ordine progressivo dimensionale**

**Figura 96**



	<b>FA6</b>	<b>OR129</b>
Lunghezza/Lenght	AKRON	Accessori/Features
615	80573	(1)C75

**Figura 97**



	<b>FA6</b>	<b>OR192</b>
Lunghezza/Lenght	AKRON	Accessori/Features
635	80820	(1)C75

**Figura 98**



	<b>FA7</b>	<b>FA7</b>
Lunghezza/Lenght	AKRON	Accessori/Features
125	80370	-

**Figura 99**



	<b>FA8</b>	<b>FB3/1</b>
Lunghezza/Lenght	AKRON	Accessori/Features
410	80333	-

**Figura 100**



	<b>FB2</b>	<b>FB2</b>
Lunghezza/Lenght	AKRON	Accessori/Features
226	8027	-

**Figura 101**



	<b>FB2</b>	<b>MC1</b>
Lunghezza/Lenght	AKRON	Accessori/Features
295	8047	-
312	8044	-
320	8055	-

**Figura 102**



	<b>FB2</b>	<b>MF</b>
Lunghezza/Lenght	AKRON	Accessori/Features
345	8046	-
370	8054	-

**Figura 103**



	<b>FB2</b>	<b>OR</b>
Lunghezza/Lenght	AKRON	Accessori/Features
283	8026	-
406	8065	-

**Figura 104**



	<b>FB3</b>	<b>FB3</b>
Lunghezza/Lenght	AKRON	Accessori/Features
225	80591	-
236	8240	-
254	8475	-
285	8238	-
300	8241	-
331	80255	(2)C16
535	80240	(2)C14

**Figura 105**



<b>FB3</b>		<b>MC11</b>
Lunghezza/Lenght	AKRON	Accessori/Features
210	8239	-
280	8049	-
350	8237	-
445	80590	(1)C4

**Figura 106**



<b>FB3</b>		<b>MC55</b>
Lunghezza/Lenght	AKRON	Accessori/Features
485	80299	-

**Figura 107**



<b>FB3</b>		<b>OR16</b>
Lunghezza/Lenght	AKRON	Accessori/Features
370	8014	-

**Figura 108**



<b>FB3</b>		<b>OR98</b>
Lunghezza/Lenght	AKRON	Accessori/Features
440	80638	-

**Figura 109**



<b>FB3/1</b>		<b>FB3/1</b>
Lunghezza/Lenght	AKRON	Accessori/Features
195	8541	-
245	80293	(1)C26
247	80014	-

**segue Figura 109**

<b>FB3/1</b>		<b>FB3/1</b>
Lunghezza/Lenght	AKRON	Accessori/Features
250	80015	-
310	80327	(1)C26-(1)C6

**Figura 110**



<b>FB3/1</b>		<b>MC43</b>
Lunghezza/Lenght	AKRON	Accessori/Features
235	8614	-
245	80597	(1)C3

**Figura 111**



<b>FB3/1</b>		<b>OR1</b>
Lunghezza/Lenght	AKRON	Accessori/Features
305	8540	-
310	8545	(1)C14

**Figura 112**



<b>FB3/1</b>		<b>OR7</b>
Lunghezza/Lenght	AKRON	Accessori/Features
410	8619	(1)C72-(1)C14
445	80598	(1)C72-(1)C14

**Figura 113**



<b>FB3/1</b>		<b>OR19</b>
Lunghezza/Lenght	AKRON	Accessori/Features
340	8615	(1)C14



**Tubi flessibili per freno**  
**suddivisi per tipo ed elencati**  
**in ordine progressivo dimensionale**

**Figura 114**



<b>FB3/1</b>		<b>OR31</b>
Lunghezza/Lenght	AKRON	Accessori/Features
435	<b>80292</b>	(1)C52
435	<b>80312</b>	(1)C52
485	<b>80314</b>	(1)C52-(1)C14
580	<b>80290</b>	(1)C52-(1)C27

**Figura 115**



<b>FB3/1</b>		<b>OR33</b>
Lunghezza/Lenght	AKRON	Accessori/Features
425	<b>80013</b>	(1)C14-(1)C6

**Figura 116**



<b>FB3/1</b>		<b>OR37</b>
Lunghezza/Lenght	AKRON	Accessori/Features
376	<b>80016</b>	(1)C52
376	<b>80017</b>	(1)C52
385	<b>80288</b>	(1)C52
450	<b>80322</b>	(1)C52

**Figura 117**



<b>FB3/1</b>		<b>OR73</b>
Lunghezza/Lenght	AKRON	Accessori/Features
440	<b>80334</b>	(1)C72

**Figura 118**



<b>FB3/1</b>		<b>OR106</b>
Lunghezza/Lenght	AKRON	Accessori/Features
400	<b>80436</b>	-

**Figura 119**



<b>FB3/1</b>		<b>OR108</b>
Lunghezza/Lenght	AKRON	Accessori/Features
400	<b>80435</b>	-

**Figura 120**



<b>FB4</b>		<b>FB4</b>
Lunghezza/Lenght	AKRON	Accessori/Features
204	<b>8086</b>	-
224	<b>8067</b>	-
240	<b>8143</b>	-
255	<b>8360</b>	-

**Figura 121**



<b>FB4</b>		<b>MC11</b>
Lunghezza/Lenght	AKRON	Accessori/Features
370	<b>8361</b>	(1)C8
380	<b>80338</b>	-

**Figura 122**



<b>FB4</b>		<b>MC14</b>
Lunghezza/Lenght	AKRON	Accessori/Features
265	<b>8268</b>	-
295	<b>8019</b>	-
305	<b>8282</b>	-
325	<b>8138</b>	-
345	<b>8315</b>	-
430	<b>8273</b>	-

**Figura 123**



<b>FB4</b>		<b>MC14/1</b>
Lunghezza/Lenght	AKRON	Accessori/Features
305	8359	(1)C8

**Figura 124**



<b>FB4</b>		<b>MP6</b>
Lunghezza/Lenght	AKRON	Accessori/Features
175	8083	-
250	8017	(1)C18

**Figura 125**



<b>FB4</b>		<b>OR</b>
Lunghezza/Lenght	AKRON	Accessori/Features
240	8016	-
265	8269	-
268	8314	-
275	8072	-
285	8144	-
285	8327	-
300	8266	-
300	8320	-
305	8362	(1)C14
315	8066	-
315	8316	-
320	8367	-
325	8084	-
370	8281	-
380	8322	-
405	8136	-
410	8141	-
432	8142	-
450	8526	(1)C27-(1)C8
493	8527	(1)C27-(1)C8
495	8075	-

**Figura 126**



<b>FB4</b>		<b>OR10</b>
Lunghezza/Lenght	AKRON	Accessori/Features
370	8305	-
465	8321	(1)C10
490	8303	(1)C11-(4)C23
490	8304	(1)C18-(1)C11

**Figura 127**



<b>FB8</b>		<b>MP4</b>
Lunghezza/Lenght	AKRON	Accessori/Features
288	8308	-
298	8095	-

**Figura 128**



<b>FB11</b>		<b>FB11</b>
Lunghezza/Lenght	AKRON	Accessori/Features
320	8280	-

**Figura 129**



<b>FB12</b>		<b>FB12</b>
Lunghezza/Lenght	AKRON	Accessori/Features
195	8223	-
330	8221	-
370	8220	-
385	8214	-
410	8213	-



**Tubi flessibili per freno**  
**suddivisi per tipo ed elencati**  
**in ordine progressivo dimensionale**

**Figura 130**



	<b>FB12</b>	<b>MC11</b>
Lunghezza/Lenght	AKRON	Accessori/Features
425	8219	-
455	8218	(1)C18

**Figura 131**



	<b>FB12</b>	<b>MC49/1</b>
Lunghezza/Lenght	AKRON	Accessori/Features
230	8210	-
360	8211	-

**Figura 132**



	<b>FB12</b>	<b>OR5</b>
Lunghezza/Lenght	AKRON	Accessori/Features
560	8537	-

**Figura 133**



	<b>FB13</b>	<b>OR13</b>
Lunghezza/Lenght	AKRON	Accessori/Features
545	8697	(1)C32

**Figura 134**



	<b>FB14</b>	<b>FB14</b>
Lunghezza/Lenght	AKRON	Accessori/Features
380	8271	-
430	8272	-

**Figura 135**



	<b>FB18</b>	<b>MP15</b>
Lunghezza/Lenght	AKRON	Accessori/Features
345	8323	-

**Figura 136**



	<b>FB19</b>	<b>MP16</b>
Lunghezza/Lenght	AKRON	Accessori/Features
325	8324	-

**Figura 137**



	<b>FB20</b>	<b>FB20</b>
Lunghezza/Lenght	AKRON	Accessori/Features
305	80135	-
340	8114	-
345	80144	-
370	80126	-
382	80132	-

**Figura 138**



	<b>FB20</b>	<b>FB66</b>
Lunghezza/Lenght	AKRON	Accessori/Features
470	80145	-

**Figura 139**



	<b>FB20</b>	<b>OR45</b>
Lunghezza/Lenght	AKRON	Accessori/Features
352	80137	-

**Figura 140**



	<b>FB20</b>	<b>OR53</b>
Lunghezza/Lenght	AKRON	Accessori/Features
479	<b>80131</b>	(1)C55
486	<b>80134</b>	(1)C55

**Figura 141**



	<b>FB20</b>	<b>OR54</b>
Lunghezza/Lenght	AKRON	Accessori/Features
352	<b>80138</b>	-

**Figura 142**



	<b>FB20</b>	<b>OR101</b>
Lunghezza/Lenght	AKRON	Accessori/Features
270	<b>80613</b>	-

**Figura 143**



	<b>FB20</b>	<b>OR113</b>
Lunghezza/Lenght	AKRON	Accessori/Features
265	<b>80612</b>	-

**Figura 144**



	<b>FB21</b>	<b>MC9</b>
Lunghezza/Lenght	AKRON	Accessori/Features
285	<b>8642</b>	-

**Figura 145**



	<b>FB22</b>	<b>FB22</b>
Lunghezza/Lenght	AKRON	Accessori/Features
220	<b>80569</b>	-
230	<b>80414</b>	-
280	<b>80325</b>	-
330	<b>80316</b>	-
405	<b>80565</b>	(1)C69
	<b>80641</b>	(1)C27

**Figura 146**



	<b>FB22</b>	<b>OR22</b>
Lunghezza/Lenght	AKRON	Accessori/Features
270	<b>80894</b>	-

**Figura 147**



	<b>FB22</b>	<b>OR23</b>
Lunghezza/Lenght	AKRON	Accessori/Features
474	<b>8694</b>	(1)C30-(1)C27
490	<b>80357</b>	(1)C73-(1)C65
525	<b>80568</b>	(1)C70-(1)C27

**Figura 148**



	<b>FB22</b>	<b>OR31</b>
Lunghezza/Lenght	AKRON	Accessori/Features
285	<b>80028</b>	(1)C26
365	<b>80520</b>	-
365	<b>80521</b>	-
385	<b>80026</b>	(1)C26-(1)C47
385	<b>80027</b>	(1)C26-(1)C47
435	<b>80512</b>	(1)C101
435	<b>80513</b>	(1)C103



**Tubi flessibili per freno**  
**suddivisi per tipo ed elencati**  
**in ordine progressivo dimensionale**

**segue Figura 148**

 <b>FB22</b>	<b>OR31</b>	
Lunghezza/Lenght	AKRON	Accessori/Features
440	<b>80510</b>	(1)C101
440	<b>80511</b>	(1)C103
485	<b>80386</b>	(1)C71-(1)C27
485	<b>80390</b>	(1)C71
485	<b>80393</b>	(1)C71-(1)C27
505	<b>80484</b>	(1)C95-(1)C27
505	<b>80485</b>	(1)C91-(1)C27
520	<b>80478</b>	(1)C99-(1)C25
520	<b>80479</b>	(1)C92-(1)C27
520	<b>80496</b>	(1)C95-(1)C25
520	<b>80497</b>	(1)C91-(1)C25
535	<b>80482</b>	(1)C91-(1)C25
535	<b>80483</b>	(1)C95-(1)C25
	<b>80640</b>	(1)C27

**Figura 149**



 <b>FB22</b>	<b>OR33</b>	
Lunghezza/Lenght	AKRON	Accessori/Features
300	<b>80902</b>	(1)C27

**Figura 150**



 <b>FB22</b>	<b>OR91</b>	
Lunghezza/Lenght	AKRON	Accessori/Features
350	<b>80517</b>	-
715	<b>80506</b>	(1)C102-(1)C98-(1)C96-(1)C27
715	<b>80507</b>	(1)C100-(1)C90-(1)C97-(1)C27
715	<b>80629</b>	(1)C102-(1)105-(1)C100-(1)C27
715	<b>80630</b>	(1)C100-(1)C94-(1)C97-(1)C27

**Figura 151**



 <b>FB22</b>	<b>OR102</b>	
Lunghezza/Lenght	AKRON	Accessori/Features
265	<b>80514</b>	-

**Figura 152**



 <b>FB22</b>	<b>OR103</b>	
Lunghezza/Lenght	AKRON	Accessori/Features
340	<b>80523</b>	(1)C27

**Figura 153**



 <b>FB22</b>	<b>OR105</b>	
Lunghezza/Lenght	AKRON	Accessori/Features
505	<b>80564</b>	(1)C69-(1)C7

**Figura 154**



 <b>FB22</b>	<b>OR107</b>	
Lunghezza/Lenght	AKRON	Accessori/Features
425	<b>80561</b>	(1)C30
425	<b>80626</b>	(1)C30
430	<b>80562</b>	(1)C30

**Figura 155**



 <b>FB22</b>	<b>OR124</b>	
Lunghezza/Lenght	AKRON	Accessori/Features
340	<b>80522</b>	(1)C27



**Tubi flessibili per freno**  
**suddivisi per tipo ed elencati**  
**in ordine progressivo dimensionale**

**segue Figura 158**

 <b>FB23</b>	<b>MC11</b>	
Lunghezza/Lenght	AKRON	Accessori/Features
360	<b>8517</b>	-
361	<b>8357</b>	(1)C18-(1)C14-(3)C23
361	<b>8358</b>	(1)C14-(3)C23
361	<b>8363</b>	(1)C8-(4)C23
367	<b>8394</b>	(1)C25
370	<b>8383</b>	-
370	<b>8387</b>	(1)C18
380	<b>8010</b>	-
382	<b>80177</b>	-
385	<b>80262</b>	(1)C66-(1)C14-(1)C10
385	<b>80755</b>	(1)C112-(1)C14-(1)C10
385	<b>8481</b>	(1)C14-(1)C5
385	<b>8482</b>	(1)C14-(1)C5-(4)C23
385	<b>8559</b>	(2)C3-(1)C19-(1)C5
385	<b>8920</b>	(1)C12
388	<b>8364</b>	(1)C14-(1)C80
388	<b>8365</b>	(1)C14-(1)C8-(3)C23
390	<b>8403</b>	(1)C10-(2)C24-(3)C23
390	<b>8405</b>	(1)C8-(4)C23
401	<b>8504</b>	-
402	<b>8431</b>	(1)C14-(1)C12-(3)C23
405	<b>8390</b>	(1)C14
405	<b>8415</b>	(1)C5-(2)C24-(3)C23
407	<b>8401</b>	(1)C10
407	<b>8424</b>	(1)C12-(2)C24
407	<b>8433</b>	(1)C10-(2)C24-(2)C23
408	<b>8426</b>	(1)C12-(3)C24
410	<b>8381</b>	(1)C12-(1)C24-(4)C23
410	<b>8407</b>	(1)C8-(1)C24
410	<b>8484</b>	(1)C14-(1)C10-(4)C23
410	<b>8696</b>	(1)C18-(1)C3-(1)C5-(1)C2
415	<b>8552</b>	(1)C5-(2)C24-(3)C23
420	<b>80175</b>	(1)C3-(1)C13-(1)C17
420	<b>8483</b>	(1)C14-(1)C10
420	<b>8567</b>	(1)C5-(2)C24
421	<b>8355</b>	(1)C8-(1)C24-(4)C23
425	<b>80188</b>	(1)C14-(1)C5
425	<b>8560</b>	(2)C3-(1)C19-(1)C5
425	<b>80189</b>	(1)C14-(1)C5-(1)C24
425	<b>80720</b>	(1)C14-(1)C5
428	<b>8435</b>	(1)C18-(1)C10

**segue Figura 158**

 <b>FB23</b>	<b>MC11</b>	
Lunghezza/Lenght	AKRON	Accessori/Features
430	<b>80718</b>	(1)C14-(1)C10-(1)C3
430	<b>80745</b>	(1)C14-(1)C5
430	<b>8492</b>	(1)C18-(1)C10-(3)C23
435	<b>80963</b>	(1)C14-(1)C5
435	<b>8436</b>	(1)C10-(2)C24-(3)C23
435	<b>8512</b>	(1)C8-(2)C24
435	<b>8529</b>	(1)C24
435	<b>8553</b>	(1)C5-(2)C24-(3)C23
435	<b>8554</b>	(2)C3-(1)C5
435	<b>8568</b>	(1)C5
435	<b>8917</b>	(2)C3-(1)C5
436	<b>8350</b>	(1)C8
436	<b>8352</b>	(1)C8-(4)C23
450	<b>8902</b>	(1)C7-(1)C5
455	<b>80719</b>	(1)C10-(2)C2
460	<b>8375</b>	(1)C10
460	<b>8410</b>	(1)C14-(1)C12-(1)C24
460	<b>8411</b>	(1)C14-(1)C8-(3)C23
460	<b>8413</b>	(1)C12-(1)C24
460	<b>8428</b>	(1)C12-(1)C24-(3)C23
460	<b>8562</b>	(2)C3-(1)C5
463	<b>8353</b>	(1)C8-(1)C24
465	<b>80180</b>	(1)C14-(1)C9
470	<b>80178</b>	(1)C18-(1)C13-(1)C24-(1)C17
470	<b>8447</b>	(1)C14-(1)C10-(3)C24
470	<b>8563</b>	(1)C10-(1)C19-(3)C24
470	<b>8564</b>	(1)C10-(1)C19-(4)C24
476	<b>80184</b>	(1)C16-(1)C18-(1)C13-(1)C24
480	<b>8264</b>	(1)C112-(1)C111-(1)C9
482	<b>8432</b>	(1)C10-(4)C23
485	<b>8606</b>	(2)C3-(1)C5
487	<b>8371</b>	(1)C10-(4)C23
490	<b>8571</b>	(1)C14-(1)C13-(1)C24-(3)C23
495	<b>80182</b>	(1)C14-(1)C9
500	<b>80183</b>	(1)C14-(2)C3-(1)C13
500	<b>8915</b>	(2)C3-(1)C5
500	<b>8946</b>	-
505	<b>81035</b>	(1)C14-(1)C5
515	<b>80243</b>	(1)C10-(1)C3
515	<b>80448</b>	(2)C3-(1)C5
524	<b>80185</b>	(1)C16-(1)C13-(1)C5





*Tubi flessibili per freno  
suddivisi per tipo ed elencati  
in ordine progressivo dimensionale*

**Figura 166**



<b>FB26</b>		<b>FB26</b>
-------------	--	-------------

<b>FB26</b>		<b>OR33</b>
-------------	--	-------------

Lunghezza/Lenght	AKRON	Accessori/Features
260 - 235	<b>80975</b>	-

**Figura 167**



<b>FB26</b>		<b>FC10</b>
-------------	--	-------------

<b>FB26</b>		<b>OR33</b>
-------------	--	-------------

Lunghezza/Lenght	AKRON	Accessori/Features
330 - 235	<b>80974</b>	-

**Figura 168**



<b>FB26</b>		<b>OR2</b>
-------------	--	------------

Lunghezza/Lenght	AKRON	Accessori/Features
470	<b>80461</b>	(1)C81
470	<b>80462</b>	(1)C81
480	<b>8476</b>	(1)C47

**Figura 169**



<b>FB26</b>		<b>OR31</b>
-------------	--	-------------

Lunghezza/Lenght	AKRON	Accessori/Features
490	<b>80970</b>	(1)C81
495	<b>80971</b>	(1)C81

**Figura 170**



<b>FB26</b>		<b>OR33</b>
-------------	--	-------------

Lunghezza/Lenght	AKRON	Accessori/Features
475	<b>80627</b>	(1)C81
475	<b>80628</b>	(1)C81

**Figura 171**



<b>FB26</b>		<b>OR50</b>
-------------	--	-------------

Lunghezza/Lenght	AKRON	Accessori/Features
345	<b>80992</b>	(1)C111

**Figura 172**



<b>FB26</b>		<b>OR91</b>
-------------	--	-------------

Lunghezza/Lenght	AKRON	Accessori/Features
575	<b>80968</b>	(1)C81
575	<b>80969</b>	(1)C81

**Figura 173**



<b>FB26</b>		<b>OR150</b>
-------------	--	--------------

Lunghezza/Lenght	AKRON	Accessori/Features
505	<b>80763</b>	(1)C81
510	<b>80762</b>	(1)C81

**Figura 174**



<b>FB26</b>		<b>OR172</b>
-------------	--	--------------

Lunghezza/Lenght	AKRON	Accessori/Features
460	<b>80769</b>	(1)C81

**Figura 175**



	<b>FB26</b>	<b>OR185</b>
Lunghezza/Lenght	AKRON	Accessori/Features
605	80766	(1)C81

**Figura 176**



	<b>FB26</b>	<b>OR193</b>
Lunghezza/Lenght	AKRON	Accessori/Features
460	80768	(1)C81
490	80669	(1)C81

**Figura 177**



	<b>FB26</b>	<b>OR196</b>
Lunghezza/Lenght	AKRON	Accessori/Features
605	80767	(1)C81

**Figura 178**



	<b>FB26</b>	<b>OR207</b>
Lunghezza/Lenght	AKRON	Accessori/Features
230	80993	(1)C26

**Figura 179**



	<b>FB26</b>	<b>OR210</b>
Lunghezza/Lenght	AKRON	Accessori/Features
345	80988	(2)C26-(2)C23
350	80989	(2)C26-(2)C23
525	80986	(1)C72-(2)C85-(2)C26-(2)C23
525	80987	(1)C72-(3)C26

**Figura 180**



	<b>FB26</b>	<b>OR234</b>
Lunghezza/Lenght	AKRON	Accessori/Features
490	80764	(1)C81

**Figura 181**



	<b>FB26</b>	<b>OR236</b>
Lunghezza/Lenght	AKRON	Accessori/Features
490	80765	(1)C81



**Figura 182**



	<b>FB26</b>	<b>OR237</b>
Lunghezza/Lenght	AKRON	Accessori/Features
445	80667	(1)C81
445	80668	(1)C81

**Figura 183**



	<b>FB26/1</b>	<b>FB26/1</b>	
Lunghezza/Lenght	AKRON	Accessori/Features	
245	80304	-	
248	8078	-	
260	80025	-	
280	80680	(2)C26-(1)C23	
285	80283	-	
290	8070	(1)C14	
345	80020	(1)C33	
380	80313	(1)C33	
400	80295	-	



**Tubi flessibili per freno**  
**suddivisi per tipo ed elencati**  
**in ordine progressivo dimensionale**

**Figura 184**



	<b>FB26/1</b>	<b>OR2</b>
Lunghezza/Lenght	AKRON	Accessori/Features
448	<b>80678</b>	(1)C118-(3)C85-(2)C23
500	<b>8069</b>	(1)C33
505	<b>8478</b>	(1)C50
645	<b>80339</b>	(1)C32-(1)C16
677	<b>80018</b>	(1)C34-(1)C33-(1)C47
677	<b>80019</b>	(1)C34-(1)C33-(1)C47
685	<b>8093</b>	(1)C34-(1)C33
685	<b>8094</b>	(1)C34-(1)C33
700	<b>80332</b>	(1)C34-(1)C33-(1)C47
700	<b>80337</b>	(1)C34-(1)C33-(1)C47
705	<b>80474</b>	(1)C81-(1)C80-(1)C47
705	<b>80475</b>	(1)C81-(1)C80-(1)C47

**Figura 185**



	<b>FB26/1</b>	<b>OR31</b>
Lunghezza/Lenght	AKRON	Accessori/Features
225	<b>80291</b>	-
575	<b>80274</b>	(2)C50
580	<b>80300</b>	(2)C33
700	<b>80466</b>	(1)C81-(1)C80-(1)C47
700	<b>80467</b>	(1)C81-(1)C80-(1)C47

**Figura 186**



	<b>FB26/1</b>	<b>OR33</b>
Lunghezza/Lenght	AKRON	Accessori/Features
235	<b>80021</b>	-
440	<b>80468</b>	(1)C81
440	<b>80469</b>	(1)C81
440	<b>80472</b>	(1)C81
440	<b>80473</b>	(1)C81
670	<b>80024</b>	(1)C34-(1)C33-(1)C48
675	<b>80022</b>	(1)C34-(1)C33-(1)C8
675	<b>80023</b>	(1)C34-(1)C33-(1)C8

**Figura 187**



	<b>FB26/1</b>	<b>OR51</b>
Lunghezza/Lenght	AKRON	Accessori/Features
430	<b>80470</b>	(1)C81
430	<b>80471</b>	(1)C81
450	<b>80631</b>	(1)C81
450	<b>80632</b>	(1)C81
455	<b>80463</b>	(1)C81
455	<b>80464</b>	(1)C81
500	<b>80465</b>	(1)C81

**Figura 188**



	<b>FB26/1</b>	<b>OR95</b>
Lunghezza/Lenght	AKRON	Accessori/Features
445	<b>80538</b>	(1)C72-(3)C85-(2)C24

**Figura 189**



	<b>FB26/1</b>	<b>OR98</b>
Lunghezza/Lenght	AKRON	Accessori/Features
705	<b>80455</b>	(1)C81-(1)C80-(1)C46
710	<b>80456</b>	(1)C34-(1)C33-(1)C47

**Figura 190**



	<b>FB26/1</b>	<b>OR110</b>
Lunghezza/Lenght	AKRON	Accessori/Features
460	<b>80457</b>	(1)C81
460	<b>80458</b>	(1)C81

**Figura 191**



<b>FB26/1</b>		<b>OR117</b>
Lunghezza/Lenght	AKRON	Accessori/Features
425	80459	(1)C81
425	80460	(1)C81

**Figura 192**



<b>FB31</b>		<b>FB31</b>
Lunghezza/Lenght	AKRON	Accessori/Features
347	80133	-
350	8538	-
370	8539	-

**Figura 193**



<b>FB31</b>		<b>MC49</b>
Lunghezza/Lenght	AKRON	Accessori/Features
185	80147	-
345	80139	-
354	80148	-
380	80140	-
431	80146	-

**Figura 194**



<b>FB31</b>		<b>MC50</b>
Lunghezza/Lenght	AKRON	Accessori/Features
485	8113	(1)C31

**Figura 195**



<b>FB31</b>		<b>OR53</b>
Lunghezza/Lenght	AKRON	Accessori/Features
494	80125	(1)C55

**Figura 196**



<b>FB31/1</b>		<b>FB31/1</b>
Lunghezza/Lenght	AKRON	Accessori/Features
140	8523	-
204	80116	-
265	8107	-

**Figura 197**



<b>FB31/1</b>		<b>OR23</b>
Lunghezza/Lenght	AKRON	Accessori/Features
470	8522	(1)C28

**Figura 198**



<b>FB31/1</b>		<b>OR24</b>
Lunghezza/Lenght	AKRON	Accessori/Features
220	8111	-

**Figura 199**



<b>FB40</b>		<b>FB40</b>
Lunghezza/Lenght	AKRON	Accessori/Features
315	8222	-
385	8688	-

**Tubi flessibili per freno  
suddivisi per tipo ed elencati  
in ordine progressivo dimensionale**

**Figura 200**



<b>FB41</b>		<b>FB41</b>	
Lunghezza/Lenght	AKRON	Accessori/Features	
210	<b>80566</b>	-	
220	<b>80049</b>	-	
238	<b>80051</b>	-	
260	<b>80047</b>	(1)C27	
264	<b>80046</b>	-	
290	<b>80048</b>	(1)C27	
318	<b>80044</b>	(1)C27	
364	<b>80052</b>	(1)C25	
380	<b>80050</b>	-	

**Figura 201**



<b>FB41</b>		<b>MC50</b>	
Lunghezza/Lenght	AKRON	Accessori/Features	
420	<b>80107</b>	-	

**Figura 202**



<b>FB42</b>		<b>FB42</b>	
Lunghezza/Lenght	AKRON	Accessori/Features	
225	<b>8609</b>	(1)C3	
305	<b>8646</b>	(2)C3	
465	<b>8916</b>	(2)C14-(1)C22	

**Figura 203**



<b>FB42</b>		<b>MC11</b>	
Lunghezza/Lenght	AKRON	Accessori/Features	
420	<b>80216</b>	(1)C14-(1)C5-(1)C16	
475	<b>8998</b>	(1)C18-(1)C14-(1)C4	

**Figura 204**



<b>FB42</b>		<b>MC45</b>	
Lunghezza/Lenght	AKRON	Accessori/Features	
315	<b>8647</b>	(1)C3	

**Figura 205**



<b>FB42</b>		<b>MC49</b>	
Lunghezza/Lenght	AKRON	Accessori/Features	
195	<b>8923</b>	-	

**Figura 206**



<b>FB42</b>		<b>MC54</b>	
Lunghezza/Lenght	AKRON	Accessori/Features	
250	<b>80967</b>	-	
285	<b>80966</b>	-	
345	<b>80263</b>	(1)C2	
370	<b>8608</b>	(2)C2-(1)C4	
385	<b>80261</b>	(1)C2	
445	<b>80267</b>	(1)C3-(1)C4-(1)C16	

**Figura 207**



<b>FB42</b>		<b>MC55</b>	
Lunghezza/Lenght	AKRON	Accessori/Features	
410	<b>80306</b>	(1)C14-(1)C5	
410	<b>80898</b>	(1)C14-(1)C5	
420	<b>80539</b>	(1)C14-(1)C5-(1)C16	
435	<b>80750</b>	(1)C14-(1)C5	
440	<b>80321</b>	(1)C18-(1)C14-(1)C5	
450	<b>81037</b>	(1)C14-(1)C5	
450	<b>81038</b>	(1)C14-(1)C5-(1)C16	
500	<b>80761</b>	(1)C18-(1)C14-(1)C5	

**Figura 208**



<b>FB42</b>		<b>MC58</b>	
Lunghezza/Lenght	AKRON	Accessori/Features	
313	8999	(1)C3	

**Figura 209**



<b>FB42</b>		<b>MCL</b>	
Lunghezza/Lenght	AKRON	Accessori/Features	
345	8686	-	
425	8645	(2)C2-(1)C4	
438	80246	(1)C14-(1)C5	

**Figura 210**



<b>FB42</b>		<b>MG13</b>	
Lunghezza/Lenght	AKRON	Accessori/Features	
445	80639	(1)C72-(1)C2-(1)C65	

**Figura 211**



<b>FB42</b>		<b>OR20</b>	
Lunghezza/Lenght	AKRON	Accessori/Features	
325	8649	(1)C14	

**Figura 212**



<b>FB43</b>		<b>FB43</b>	
Lunghezza/Lenght	AKRON	Accessori/Features	
292	80098	-	
300	80087	-	
310	80063	-	
325	80100	-	
430	80058	-	

**Figura 213**



<b>FB43</b>		<b>FB52</b>	
Lunghezza/Lenght	AKRON	Accessori/Features	
270	80268	-	

**Figura 214**



<b>FB43</b>		<b>OR2</b>	
Lunghezza/Lenght	AKRON	Accessori/Features	
225	80073	-	
555	80064	(1)C51	
573	80055	(1)C51	
610	80572	(1)C51	
615	80273	(1)C51	

**Figura 215**



<b>FB43</b>		<b>OR13</b>	
Lunghezza/Lenght	AKRON	Accessori/Features	
435	80237	(1)C53	

**Figura 216**



<b>FB43</b>		<b>OR18</b>	
Lunghezza/Lenght	AKRON	Accessori/Features	
435	8617	(1)C32	

**Figura 217**



<b>FB43</b>		<b>OR33</b>	
Lunghezza/Lenght	AKRON	Accessori/Features	
490	80057	(1)C51	
510	80053	(1)C51-(1)C18	
550	80065	(1)C51	

*Tubi flessibili per freno  
suddivisi per tipo ed elencati  
in ordine progressivo dimensionale*

**Figura 218**



 <b>FB43</b>	<b>OR34</b>	
Lunghezza/Lenght	AKRON	Accessori/Features
470	<b>80105</b>	(1)C51
470	<b>80106</b>	(1)C51

**Figura 219**



 <b>FB43</b>	<b>OR39</b>	
Lunghezza/Lenght	AKRON	Accessori/Features
370	<b>80077</b>	-
400	<b>80083</b>	-

**Figura 220**



 <b>FB43</b>	<b>OR46</b>	
Lunghezza/Lenght	AKRON	Accessori/Features
410	<b>80059</b>	(1)C51

**Figura 221**



 <b>FB43</b>	<b>OR47</b>	
Lunghezza/Lenght	AKRON	Accessori/Features
410	<b>80060</b>	(1)C51

**Figura 222**



 <b>FB43</b>	<b>OR48</b>	
Lunghezza/Lenght	AKRON	Accessori/Features
395	<b>80061</b>	(1)C51-(2)C8

**Figura 223**



 <b>FB43</b>	<b>OR49</b>	
Lunghezza/Lenght	AKRON	Accessori/Features
395	<b>80062</b>	(1)C51

**Figura 224**



 <b>FB43</b>	<b>OR50</b>	
Lunghezza/Lenght	AKRON	Accessori/Features
533	<b>80095</b>	(1)C51

**Figura 225**



 <b>FB43</b>	<b>OR51</b>	
Lunghezza/Lenght	AKRON	Accessori/Features
520	<b>80097</b>	(1)C51

**Figura 226**



 <b>FB43</b>	<b>OR52</b>	
Lunghezza/Lenght	AKRON	Accessori/Features
442	<b>80099</b>	(1)C51

**Figura 227**



 <b>FB43</b>	<b>OR87</b>	
Lunghezza/Lenght	AKRON	Accessori/Features
465	<b>80103</b>	(1)C75

**Figura 228**



<b>FB43</b>		<b>OR94</b>
Lunghezza/Lenght	AKRON	Accessori/Features
263	80072	-

**Figura 229**



<b>FB43</b>		<b>OR97</b>
Lunghezza/Lenght	AKRON	Accessori/Features
190/265	80088	(1)C61-(3)C66
505	80086	(1)C65-(1)C75
520	80578	(1)C51-(1)C66

**Figura 230**



<b>FB43</b>		<b>OR116</b>
Lunghezza/Lenght	AKRON	Accessori/Features
175	80579	-

**Figura 231**



<b>FB43</b>		<b>OR200</b>
Lunghezza/Lenght	AKRON	Accessori/Features
255	80690	-

**Figura 232**



<b>FB44</b>		<b>FC1</b>
Lunghezza/Lenght	AKRON	Accessori/Features
468	8618	-

**Figura 233**



<b>FB44</b>		<b>OR42</b>
Lunghezza/Lenght	AKRON	Accessori/Features
450	80557	(1)C56-(1)C3

**Figura 234**



<b>FB46</b>		<b>MC11</b>
Lunghezza/Lenght	AKRON	Accessori/Features
460	8575	(1)C7

**Figura 235**



<b>FB47</b>		<b>MC11</b>
Lunghezza/Lenght	AKRON	Accessori/Features
460	8029	(1)C7

**Figura 236**



<b>FB48</b>		<b>FB48</b>
Lunghezza/Lenght	AKRON	Accessori/Features
300	80259	-

**Figura 237**



<b>FB48</b>		<b>MC49/1</b>
Lunghezza/Lenght	AKRON	Accessori/Features
450	80387	-
495	80396	-
558,5	80081	-

**Tubi flessibili per freno**  
**suddivisi per tipo ed elencati**  
**in ordine progressivo dimensionale**

**Figura 238**



	<b>FB48</b>	<b>MC50</b>	
Lunghezza/Lenght	AKRON	Accessori/Features	
214	80045	-	
318	80136	-	
410	80101	-	
435	80079	-	
462	80076	-	

**Figura 239**



	<b>FB48</b>	<b>MC50/1</b>	
Lunghezza/Lenght	AKRON	Accessori/Features	
420	80358	(1)C56	

**Figura 240**



	<b>FB48</b>	<b>OR2</b>	
Lunghezza/Lenght	AKRON	Accessori/Features	
465	80276	(1)C53	

**Figura 241**



	<b>FB48</b>	<b>OR31</b>	
Lunghezza/Lenght	AKRON	Accessori/Features	
435	80278	(1)C53	

**Figura 242**



	<b>FB49</b>	<b>FB49</b>	
Lunghezza/Lenght	AKRON	Accessori/Features	
165	8903	-	
190	81013	-	
216	80173	-	

**Figura 243**



	<b>FB49</b>	<b>FB62</b>	
Lunghezza/Lenght	AKRON	Accessori/Features	
450	81012	(1)C18-(2)C14	

**Figura 244**



	<b>FB49</b>	<b>OR22</b>	
Lunghezza/Lenght	AKRON	Accessori/Features	
435	8616	(1)C2	
545	80172	(1)C72-(1)C3	
575	80275	(1)C32-(2)C141	

**Figura 245**



	<b>FB50</b>	<b>FB50</b>	
Lunghezza/Lenght	AKRON	Accessori/Features	
265	80589	-	
275	80504	(1)C27	
295	80526	-	
340	80528	(1)C25	
260	80328	-	

**Figura 246**



	<b>FB50</b>	<b>MC50/1</b>	
Lunghezza/Lenght	AKRON	Accessori/Features	
195	80350	-	
240	80346	(1)C26	
250	80343	-	
255	80360	-	
265	80593	(1)C27	

**Figura 247**



	<b>FB50</b>	<b>MC63</b>	
Lunghezza/Lenght	AKRON	Accessori/Features	
185	<b>80527</b>	-	



**Figura 248**



	<b>FB50</b>	<b>OR102</b>	
Lunghezza/Lenght	AKRON	Accessori/Features	
455	<b>80486</b>	(1)C103	
455	<b>80487</b>	(1)C101	

**Figura 249**



	<b>FB51</b>	<b>FB51</b>	
Lunghezza/Lenght	AKRON	Accessori/Features	
185	<b>80374</b>	-	
215	<b>80368</b>	-	
235	<b>80369</b>	-	
265	<b>80371</b>	-	
295	<b>80375</b>	(1)C27	
330	<b>80366</b>	-	
335	<b>80363</b>	(1)C27	
355	<b>80567</b>	(1)C25	
380	<b>80372</b>	(1)C25	
425	<b>80394</b>	(1)C71	

**Figura 250**



	<b>FB51</b>	<b>OR2</b>	
Lunghezza/Lenght	AKRON	Accessori/Features	
355	<b>80367</b>	(1)C6	

**Figura 251**



	<b>FB51</b>	<b>OR21</b>	
Lunghezza/Lenght	AKRON	Accessori/Features	
430	<b>80391</b>	(1)C32-(1)C27	
450	<b>80389</b>	(1)C71-(1)C27	

**Figura 252**



	<b>FB51</b>	<b>OR23</b>	
Lunghezza/Lenght	AKRON	Accessori/Features	
550	<b>80442</b>	(1)C70-(1)C27	
580	<b>80606</b>	(1)C70-(1)C27	



**Figura 253**



	<b>FB51</b>	<b>OR31</b>	
Lunghezza/Lenght	AKRON	Accessori/Features	
440	<b>80502</b>	(1)C25	
440	<b>80503</b>	(1)C63	
485	<b>80395</b>	(1)C71	
485	<b>80495</b>	(1)C71	
515	<b>80476</b>	(1)C92-(1)C25	
515	<b>80477</b>	(1)C99-(1)C25	
515	<b>80480</b>	(1)C95-(1)C25	
515	<b>80481</b>	(1)C91-(1)C25	

**Figura 254**



	<b>FB52</b>	<b>FB52</b>	
Lunghezza/Lenght	AKRON	Accessori/Features	
235	<b>80731</b>	-	
243	<b>80121</b>	-	
243	<b>80271</b>	-	
255	<b>80825</b>	-	
255	<b>80876</b>	-	





**Tubi flessibili per freno  
suddivisi per tipo ed elencati  
in ordine progressivo dimensionale**

**segue Figura 254**

<b>FB52</b>		<b>FB52</b>	
Lunghezza/Lenght	AKRON	Accessori/Features	
257	80280	-	
260	80080	-	
285	80118	-	
293	80066	-	
300	8952	-	
305	8933	-	
307	80270	-	
325	80298	-	
325	80604	-	
325	80828	-	
330	80605	-	
330	80827	-	
365	80123	(1)C53	
385	80939	-	
400	80119	-	
421	80109	(1)C53	

**Figura 255**



<b>FB52</b>		<b>FC1</b>	
Lunghezza/Lenght	AKRON	Accessori/Features	
300	80096	-	
392	80071	-	
462	80102	-	
538	80272	-	

**Figura 256**



<b>FB52</b>		<b>OR2</b>	
Lunghezza/Lenght	AKRON	Accessori/Features	
210	80230	-	
360	80730	(1)C6	
455	80875	(1)C81-(1)C112	
457	80117	(1)C53	
463	80874	(1)C81-(1)C112	
535	80692	(1)C81	
598	80124	(2)C53	

**Figura 257**



<b>FB52</b>		<b>OR13</b>	
Lunghezza/Lenght	AKRON	Accessori/Features	
193	80260	-	

**Figura 258**



<b>FB52</b>		<b>OR21</b>	
Lunghezza/Lenght	AKRON	Accessori/Features	
525	80826	(1)C104	

**Figura 259**



<b>FB52</b>		<b>OR31</b>	
Lunghezza/Lenght	AKRON	Accessori/Features	
355	80696	(1)C18	
435	80279	(1)C50	
440	8932	(1)C32	
545	8950	(1)C53-(2)C3	

**Figura 260**



<b>FB52</b>		<b>OR33</b>	
Lunghezza/Lenght	AKRON	Accessori/Features	
280	80229	-	
410	80120	(1)C53	
475	80108	(1)C53	
480	80122	(1)C53	

**Figura 261**



<b>FB52</b>		<b>OR38</b>	
Lunghezza/Lenght	AKRON	Accessori/Features	
355	80074	-	

**Figura 262**



<b>FB52</b>		<b>OR52</b>
Lunghezza/Lenght	AKRON	Accessori/Features
405	<b>80449</b>	(1)C69

**Figura 263**



<b>FB52</b>		<b>OR90</b>
Lunghezza/Lenght	AKRON	Accessori/Features
520	<b>80603</b>	(1)C104

**Figura 264**



<b>FB52</b>		<b>OR123</b>
Lunghezza/Lenght	AKRON	Accessori/Features
385	<b>80693</b>	-

**Figura 265**



<b>FB52</b>		<b>OR129</b>
Lunghezza/Lenght	AKRON	Accessori/Features
385	<b>80694</b>	-

**Figura 266**



<b>FB52</b>		<b>OR203</b>
Lunghezza/Lenght	AKRON	Accessori/Features
465	<b>80823</b>	(1)C81-(1)C112
465	<b>80824</b>	(1)C81-(1)C112
535	<b>80691</b>	(1)C81

**Figura 267**



<b>FB54</b>		<b>FB54</b>
Lunghezza/Lenght	AKRON	Accessori/Features
165	<b>8967</b>	-
195	<b>80515</b>	(1)C26
220	<b>80516</b>	(1)C26
230	<b>80492</b>	(1)C26
260	<b>80509</b>	-
280	<b>80311</b>	(1)C27
300	<b>80029</b>	(1)C27
340	<b>80030</b>	(1)C27
360	<b>80525</b>	(1)C25
385	<b>80524</b>	-
430	<b>8969</b>	(1)C2

**Figura 268**



<b>FB54</b>		<b>MC49/1</b>
Lunghezza/Lenght	AKRON	Accessori/Features
265	<b>80508</b>	-
270	<b>80505</b>	-

**Figura 269**



<b>FB54</b>		<b>MC50/1</b>
Lunghezza/Lenght	AKRON	Accessori/Features
230	<b>80925</b>	-
240	<b>80352</b>	-
270	<b>80351</b>	-
305	<b>80665</b>	-

**Figura 270**



<b>FB54</b>		<b>MCL</b>
Lunghezza/Lenght	AKRON	Accessori/Features
370	<b>80256</b>	(1)C3
500	<b>8924</b>	(2)C2-(1)C4

*Tubi flessibili per freno  
suddivisi per tipo ed elencati  
in ordine progressivo dimensionale*

**Figura 271**



	<b>FB54</b>	<b>OR31</b>
Lunghezza/Lenght	AKRON	Accessori/Features
480	<b>80493</b>	(1)C93
480	<b>80494</b>	(1)C89

**Figura 272**



	<b>FB54</b>	<b>OR95</b>
Lunghezza/Lenght	AKRON	Accessori/Features
505	<b>80501</b>	(1)C86

**Figura 273**



	<b>FB55</b>	<b>FB55</b>
Lunghezza/Lenght	AKRON	Accessori/Features
220	<b>80302</b>	-
225	<b>80297</b>	-
235	<b>80143</b>	-
245	<b>80287</b>	-
285	<b>80323</b>	-
290	<b>80286</b>	-
300	<b>8962</b>	-
305	<b>8965</b>	-
315	<b>8959</b>	-
330	<b>80315</b>	-

**Figura 274**



	<b>FB55</b>	<b>FB56</b>
Lunghezza/Lenght	AKRON	Accessori/Features
380	<b>8955</b>	-
380	<b>8956</b>	-

**Figura 275**



	<b>FB55</b>	<b>FB59</b>
Lunghezza/Lenght	AKRON	Accessori/Features
355	<b>80130</b>	-
360	<b>80129</b>	-
375	<b>80310</b>	-
375	<b>80326</b>	-

**Figura 276**



	<b>FB55</b>	<b>OR13</b>
Lunghezza/Lenght	AKRON	Accessori/Features
595	<b>80345</b>	(1)C69
595	<b>80348</b>	(1)C69

**Figura 277**



	<b>FB55</b>	<b>OR21</b>
Lunghezza/Lenght	AKRON	Accessori/Features
235	<b>80324</b>	-

**Figura 278**



	<b>FB55</b>	<b>OR32</b>
Lunghezza/Lenght	AKRON	Accessori/Features
450	<b>80344</b>	(1)C69
450	<b>80353</b>	(1)C69
470	<b>8960</b>	(1)C50
470	<b>8961</b>	(1)C50
473	<b>8963</b>	(1)C50
483	<b>8964</b>	(1)C50
485	<b>80355</b>	(1)C69
485	<b>80359</b>	(1)C69
485	<b>80362</b>	(1)C69
490	<b>80347</b>	(1)C69





**Tubi flessibili per freno**  
**suddivisi per tipo ed elencati**  
**in ordine progressivo dimensionale**

**Figura 286**



<b>FB55</b>		<b>OR113</b>
Lunghezza/Lenght	AKRON	Accessori/Features
260	80616	-
265	80700	-

**Figura 287**



<b>FB55</b>		<b>OR118</b>
Lunghezza/Lenght	AKRON	Accessori/Features
235	80621	-
275	80610	-
470	80445	(1)C50-(1)C16

**Figura 288**



<b>FB55</b>		<b>OR127</b>
Lunghezza/Lenght	AKRON	Accessori/Features
560	8957	(1)C69
560	8958	(1)C69

**Figura 289**



<b>FB55</b>		<b>OR130</b>
Lunghezza/Lenght	AKRON	Accessori/Features
258	80141	-
595	80646	(1)C69

**Figura 290**



<b>FB55</b>		<b>OR131</b>
Lunghezza/Lenght	AKRON	Accessori/Features
258	80142	-

**Figura 291**



<b>FB55</b>		<b>OR187</b>
Lunghezza/Lenght	AKRON	Accessori/Features
300	80648	-

**Figura 292**



<b>FB55</b>		<b>OR191</b>
Lunghezza/Lenght	AKRON	Accessori/Features
595	80645	(1)C69

**Figura 293**



<b>FB55</b>		<b>OR201</b>
Lunghezza/Lenght	AKRON	Accessori/Features
295	80647	-

**Figura 294**



<b>FB57</b>		<b>FB57</b>
Lunghezza/Lenght	AKRON	Accessori/Features
222	8994	-
305	80575	-
310	80090	-
350	80239	-

**Figura 295**



<b>FB57</b>		<b>OR2</b>
Lunghezza/Lenght	AKRON	Accessori/Features
594	80094	(1)C51
600	80093	(1)C51

**Figura 296**



	<b>FB57</b>	<b>OR31</b>
Lunghezza/Lenght	AKRON	Accessori/Features
483	8995	(1)C51

**Figura 297**



	<b>FB57</b>	<b>OR33</b>
Lunghezza/Lenght	AKRON	Accessori/Features
234	8996	-
475	8993	(1)C51

**Figura 298**



	<b>FB57</b>	<b>OR43</b>
Lunghezza/Lenght	AKRON	Accessori/Features
190/265	80089	(1)C61-(3)C66

**Figura 299**



	<b>FB57</b>	<b>OR59</b>
Lunghezza/Lenght	AKRON	Accessori/Features
421	80092	(1)C51

**Figura 300**



	<b>FB57</b>	<b>OR99</b>
Lunghezza/Lenght	AKRON	Accessori/Features
500	80571	(1)C75

**Figura 301**



	<b>FB57</b>	<b>OR100</b>
Lunghezza/Lenght	AKRON	Accessori/Features
425	80577	(1)C75-(1)C66-(1)C18

**Figura 302**



	<b>FB57</b>	<b>OR112</b>
Lunghezza/Lenght	AKRON	Accessori/Features
425	80576	(1)C75-(1)C66-(1)C18

**Figura 303**



	<b>FB57</b>	<b>OR123</b>
Lunghezza/Lenght	AKRON	Accessori/Features
615	80574	(1)C51

**Figura 304**



	<b>FB57</b>	<b>OR158</b>
Lunghezza/Lenght	AKRON	Accessori/Features
635	80819	(1)C75

**Figura 305**



	<b>FB57</b>	<b>OR199</b>
Lunghezza/Lenght	AKRON	Accessori/Features
255	80821	-

*Tubi flessibili per freno  
suddivisi per tipo ed elencati  
in ordine progressivo dimensionale*

**Figura 306**



	<b>FB57</b>	<b>OR200</b>
Lunghezza/Lenght	AKRON	Accessori/Features
255	80822	-

**Figura 307**



	<b>FB58</b>	<b>FB58</b>
Lunghezza/Lenght	AKRON	Accessori/Features
225	80296	-
240	80012	-

**Figura 308**



	<b>FB58</b>	<b>OR36</b>
Lunghezza/Lenght	AKRON	Accessori/Features
440	80011	(1)C6

**Figura 309**



	<b>FB60</b>	<b>FB60</b>
Lunghezza/Lenght	AKRON	Accessori/Features
410	80009	(1)C5-(1)C24

**Figura 310**



	<b>FB60</b>	<b>FZ</b>
Lunghezza/Lenght	AKRON	Accessori/Features
210	80010	-

**Figura 311**



	<b>FB61</b>	<b>FB61</b>
Lunghezza/Lenght	AKRON	Accessori/Features
285	80752	(2)C112
325	8970	(1)C14
330	80412	(1)C14
345	80001	(1)C14

**Figura 312**



	<b>FB61</b>	<b>MG1</b>
Lunghezza/Lenght	AKRON	Accessori/Features
545	80000	(1)C72-(1)C14

**Figura 313**



	<b>FB61</b>	<b>MG16</b>
Lunghezza/Lenght	AKRON	Accessori/Features
460	81036	-

**Figura 314**



	<b>FB61</b>	<b>OR20</b>
Lunghezza/Lenght	AKRON	Accessori/Features
340	80234	(1)C14

**Figura 315**



	<b>FB61</b>	<b>OR71</b>
Lunghezza/Lenght	AKRON	Accessori/Features
405	80751	(1)C69-(4)C112

**Figura 316**



<b>FB62</b>		<b>FB62</b>	
Lunghezza/Lenght	AKRON	Accessori/Features	
175	<b>81059</b>	-	
257	<b>80161</b>	(1)C14	
265	<b>80892</b>	-	
280	<b>80724</b>	(1)C16-(1)C65	
525	<b>81020</b>	(1)C115-(1)C27-(1)C15	
527	<b>80162</b>	(1)C27-(1)C14-(1)C4	
580	<b>80723</b>	(1)C115	

**Figura 317**



<b>FB62</b>		<b>OR22</b>	
Lunghezza/Lenght	AKRON	Accessori/Features	
270	<b>80852</b>	-	
270	<b>81026</b>	-	
270	<b>81069</b>	-	
525	<b>81058</b>	(1)C72-(1)C112-(1)C15-(1)C2	
555	<b>80008</b>	(1)C115-(2)C2	
555	<b>80948</b>	(1)C115-(1)C18-(2)C2	
565	<b>80851</b>	(1)C115-(2)C2-(1)C65	
570	<b>81014</b>	(1)C115-(1)C2	
580	<b>81071</b>	(1)C72-(1)C16-(1)C65	
585	<b>80893</b>	(1)C115	
590	<b>81025</b>	(1)C115	
590	<b>81068</b>	(1)C72-(1)C15	
595	<b>80160</b>	(1)C72	
615	<b>80392</b>	(1)C72-(1)C14	
615	<b>81011</b>	(1)C115-(1)C14-(1)C2	
635	<b>80722</b>	(1)C115	

**Figura 318**



<b>FB62</b>		<b>OR253</b>	
Lunghezza/Lenght	AKRON	Accessori/Features	
305	<b>81067</b>	(1)C14	

**Figura 319**



<b>FB63</b>		<b>FB63</b>	
Lunghezza/Lenght	AKRON	Accessori/Features	
270	<b>80548</b>	-	
280	<b>80040</b>	-	
281	<b>80038</b>	(1)C7	
290	<b>80411</b>	-	
290	<b>80531</b>	(1)C27	
310	<b>80546</b>	-	
345	<b>80554</b>	(2)C2	

**Figura 320**



<b>FB63</b>		<b>FC1</b>	
Lunghezza/Lenght	AKRON	Accessori/Features	
375	<b>80550</b>	-	

**Figura 321**



<b>FB63</b>		<b>MC52</b>	
Lunghezza/Lenght	AKRON	Accessori/Features	
353	<b>80154</b>	-	

**Figura 322**



<b>FB63</b>		<b>OR42</b>	
Lunghezza/Lenght	AKRON	Accessori/Features	
420	<b>80042</b>	(1)C56	
435	<b>80037</b>	(1)C56	
445	<b>80553</b>	(1)C56	
545	<b>80549</b>	(1)C58	



**Tubi flessibili per freno**  
**suddivisi per tipo ed elencati**  
**in ordine progressivo dimensionale**

**Figura 323**



	<b>FB63</b>	<b>OR52</b>
Lunghezza/Lenght	AKRON	Accessori/Features
535	80043	(1)C56

**Figura 324**



	<b>FB63</b>	<b>OR80</b>
Lunghezza/Lenght	AKRON	Accessori/Features
425	80545	(1)C88-(1)C65

**Figura 325**



	<b>FB63</b>	<b>OR85</b>
Lunghezza/Lenght	AKRON	Accessori/Features
275	80222	-

**Figura 326**



	<b>FB63</b>	<b>OR90</b>
Lunghezza/Lenght	AKRON	Accessori/Features
475	80547	(1)C56

**Figura 327**



	<b>FB63</b>	<b>OR111</b>
Lunghezza/Lenght	AKRON	Accessori/Features
545	80530	(1)C27-(1)C4

**Figura 328**



	<b>FB63</b>	<b>OR119</b>
Lunghezza/Lenght	AKRON	Accessori/Features
280	80551	-

**Figura 329**



	<b>FB63</b>	<b>OR120</b>
Lunghezza/Lenght	AKRON	Accessori/Features
350	80556	(1)C2

**Figura 330**



	<b>FB63</b>	<b>OR121</b>
Lunghezza/Lenght	AKRON	Accessori/Features
280	80552	-

**Figura 331**



	<b>FB63</b>	<b>OR122</b>
Lunghezza/Lenght	AKRON	Accessori/Features
350	80555	(1)C2

**Figura 332**



	<b>FB63</b>	<b>OR126</b>
Lunghezza/Lenght	AKRON	Accessori/Features
265	80612	-

**Figura 333**



<b>FB64</b>	<b>OR42</b>	
Lunghezza/Lenght	AKRON	Accessori/Features
505	<b>80041</b>	(1)C57

**Figura 334**



<b>FB65</b>	<b>FB65</b>	
Lunghezza/Lenght	AKRON	Accessori/Features
270	<b>80382</b>	-
300	<b>80600</b>	-
310	<b>80444</b>	-
337	<b>80112</b>	-
360	<b>80378</b>	-

**Figura 335**



<b>FB65</b>	<b>OR2</b>	
Lunghezza/Lenght	AKRON	Accessori/Features
515	<b>80379</b>	(1)C69
515	<b>80383</b>	(1)C69

**Figura 336**



<b>FB65</b>	<b>OR23</b>	
Lunghezza/Lenght	AKRON	Accessori/Features
481	<b>80115</b>	(1)C28
519	<b>80110</b>	(1)C54
520	<b>80111</b>	(1)C54
555	<b>80398</b>	(1)C30
560	<b>80376</b>	(1)C30

**Figura 337**



<b>FB65</b>	<b>OR24</b>	
Lunghezza/Lenght	AKRON	Accessori/Features
520	<b>80113</b>	(1)C54
523	<b>80114</b>	(1)C54
545	<b>80377</b>	(1)C30
545	<b>80380</b>	(1)C30

**Figura 338**



<b>FB65</b>	<b>OR149</b>	
Lunghezza/Lenght	AKRON	Accessori/Features
585	<b>80869</b>	(1)C69
585	<b>80870</b>	(1)C69

**Figura 339**



<b>FB65</b>	<b>OR203</b>	
Lunghezza/Lenght	AKRON	Accessori/Features
555	<b>80858</b>	(1)C69
555	<b>80859</b>	(1)C69

**Figura 340**



<b>FB65</b>	<b>OR238</b>	
Lunghezza/Lenght	AKRON	Accessori/Features
515	<b>80871</b>	(1)C69

**Figura 341**



<b>FB65</b>	<b>OR239</b>	
Lunghezza/Lenght	AKRON	Accessori/Features
515	<b>80867</b>	(1)C123
515	<b>80868</b>	(1)C117

**Tubi flessibili per freno**  
**suddivisi per tipo ed elencati**  
**in ordine progressivo dimensionale**

**Figura 342**



<b>FB65</b>		<b>OR246</b>
Lunghezza/Lenght	AKRON	Accessori/Features
515	80872	(1)C69

**Figura 343**



<b>FB65</b>		<b>OR255</b>
Lunghezza/Lenght	AKRON	Accessori/Features
520	80860	(1)C123

**Figura 344**



<b>FB65</b>		<b>OR256</b>
Lunghezza/Lenght	AKRON	Accessori/Features
520	80861	(1)C117

**Figura 345**



<b>FB67</b>		<b>FB67</b>
Lunghezza/Lenght	AKRON	Accessori/Features
300	80150	-

**Figura 346**



<b>FB67</b>		<b>MC52</b>
Lunghezza/Lenght	AKRON	Accessori/Features
490	80149	(1)C4

**Figura 347**



<b>FB67</b>		<b>MC62</b>
Lunghezza/Lenght	AKRON	Accessori/Features
415	80532	(1)C4

**Figura 348**



<b>FB67</b>		<b>OR52</b>
Lunghezza/Lenght	AKRON	Accessori/Features
460	80787	(1)C56

**Figura 349**



<b>FB67</b>		<b>OR55</b>
Lunghezza/Lenght	AKRON	Accessori/Features
537	80151	(1)C58

**Figura 350**



<b>FB68</b>		<b>OR60</b>
Lunghezza/Lenght	AKRON	Accessori/Features
405	80039	(1)C56-(1)C65

**Figura 351**



<b>FB69</b>		<b>MG1</b>
Lunghezza/Lenght	AKRON	Accessori/Features
520	8914	(1)C72-(1)C14

**Figura 352**



	<b>FB69</b>	<b>MG7</b>
Lunghezza/Lenght	AKRON	Accessori/Features
370	80354	(1)C64-(1)C14-(2)C65

**Figura 353**



	<b>FB70</b>	<b>FB70</b>
Lunghezza/Lenght	AKRON	Accessori/Features
225	80943	-
285	80942	-

**Figura 354**



	<b>FB70</b>	<b>OR107</b>
Lunghezza/Lenght	AKRON	Accessori/Features
265	80944	-

**Figura 355**



	<b>FB71</b>	<b>FB71</b>
Lunghezza/Lenght	AKRON	Accessori/Features
185	80958	-
300	80955	-
300	80962	-

**Figura 356**



	<b>FB71</b>	<b>FB89</b>
Lunghezza/Lenght	AKRON	Accessori/Features
305	80961	(1)C112

**Figura 357**



	<b>FB71</b>	<b>OR2</b>
Lunghezza/Lenght	AKRON	Accessori/Features
570	80865	(1)C69
570	80866	(1)C69

**Figura 358**



	<b>FB71</b>	<b>OR21</b>
Lunghezza/Lenght	AKRON	Accessori/Features
500	80954	(1)C69-(3)C112

**Figura 359**



	<b>FB71</b>	<b>OR229</b>
Lunghezza/Lenght	AKRON	Accessori/Features
430	80957	(1)C69

**Figura 360**



	<b>FB71</b>	<b>OR231</b>
Lunghezza/Lenght	AKRON	Accessori/Features
430	80956	(1)C69

**Figura 361**





	<b>FB72</b>	<b>FB72</b>
Lunghezza/Lenght	AKRON	Accessori/Features
440	80432	-

**Tubi flessibili per freno**  
**suddivisi per tipo ed elencati**  
**in ordine progressivo dimensionale**

**Figura 362**



	<b>FB72</b>	<b>FC9</b>	
	Lunghezza/Lenght	AKRON	Accessori/Features
	350	80033	(4)C23

**Figura 363**



	<b>FB72</b>	<b>OR111</b>	
	Lunghezza/Lenght	AKRON	Accessori/Features
	380	80736	(1)C27-(1)C15



**Figura 364**



	<b>FB72</b>	<b>OR126</b>	
	Lunghezza/Lenght	AKRON	Accessori/Features
	390	80735	(1)C27-(1)C15

**Figura 365**



	<b>FB72</b>	<b>OR179</b>	
	Lunghezza/Lenght	AKRON	Accessori/Features
	610	80816	(1)C75

**Figura 366**



	<b>FB74</b>	<b>MG7</b>	
	Lunghezza/Lenght	AKRON	Accessori/Features
	370	80965	(1)C14



**Figura 367**



	<b>FB76</b>	<b>MC54</b>	
	Lunghezza/Lenght	AKRON	Accessori/Features
	445	80697	(1)C113-(3)C2-(1)C4-(1)C65



**Figura 368**



	<b>FB76</b>	<b>MC64</b>	
	Lunghezza/Lenght	AKRON	Accessori/Features
	215	80946	-
	420	80450	(2)C2-(1)C4-(1)C65
	420	80899	(2)C2-(1)C4-(1)C65
	435	80713	(2)C2-(1)C4-(1)C65
	455	80708	(2)C2-(1)C4-(1)C65
	520	80698	(2)C4



**Figura 369**



	<b>FB76</b>	<b>MCL2</b>	
	Lunghezza/Lenght	AKRON	Accessori/Features
	200	80760	-
	215	80356	(1)C16

**Figura 370**



	<b>FB77</b>	<b>FB77</b>	
	Lunghezza/Lenght	AKRON	Accessori/Features
	160	80882	-
	255	80373	-

**Tubi flessibili per freno**  
**suddivisi per tipo ed elencati**  
**in ordine progressivo dimensionale**

**Figura 371**



	<b>FB77</b>	<b>FB111</b>	
Lunghezza/Lenght	AKRON	Accessori/Features	
195	<b>80881</b>	-	

**Figura 372**



	<b>FB77</b>	<b>OR21</b>	
Lunghezza/Lenght	AKRON	Accessori/Features	
245	<b>80364</b>	-	
280	<b>80365</b>	-	

**Figura 373**



	<b>FB77</b>	<b>OR80</b>	
Lunghezza/Lenght	AKRON	Accessori/Features	
600	<b>80405</b>	(1)C79	
600	<b>80406</b>	(1)C79	

**Figura 374**



	<b>FB77</b>	<b>OR118</b>	
Lunghezza/Lenght	AKRON	Accessori/Features	
225	<b>80611</b>	-	

**Figura 375**



	<b>FB77</b>	<b>OR127</b>	
Lunghezza/Lenght	AKRON	Accessori/Features	
510	<b>80438</b>	(1)C69	
510	<b>80439</b>	(1)C69	
670	<b>80878</b>	(1)C120-(1)C116	
670	<b>80879</b>	(1)C125-(1)C119	

**segue Figura 375**

	<b>FB77</b>	<b>OR127</b>	
Lunghezza/Lenght	AKRON	Accessori/Features	
685	<b>80883</b>	(1)C120-(1)C116	
685	<b>80884</b>	(1)C125-(1)C119	

**Figura 376**



	<b>FB77</b>	<b>OR181</b>	
Lunghezza/Lenght	AKRON	Accessori/Features	
215	<b>80880</b>	-	

**Figura 377**



	<b>FB77</b>	<b>OR231</b>	
Lunghezza/Lenght	AKRON	Accessori/Features	
360	<b>80885</b>	(1)C69	

**Figura 378**



	<b>FB78</b>	<b>MCL2</b>	
Lunghezza/Lenght	AKRON	Accessori/Features	
435	<b>80388</b>	(1)C2-(1)C4-(1)C65	

**Figura 379**



	<b>FB79</b>	<b>FB79</b>	
Lunghezza/Lenght	AKRON	Accessori/Features	
195	<b>80303</b>	(2)C3	

**Figura 380**



	<b>FB79</b>	<b>MC55</b>	
Lunghezza/Lenght	AKRON	Accessori/Features	
440	<b>80284</b>	(1)C14-(1)C5	
515	<b>80285</b>	(1)C14-(1)C5	



**Tubi flessibili per freno**  
**suddivisi per tipo ed elencati**  
**in ordine progressivo dimensionale**

**Figura 381**



<b>FB81</b>		<b>OR233</b>
Lunghezza/Lenght	AKRON	Accessori/Features
275	81019	-

**Figura 382**



<b>FB81</b>		<b>OR235</b>
Lunghezza/Lenght	AKRON	Accessori/Features
500	81015	(1)C122-(1)C7
500	81016	(1)C121-(1)C7

**Figura 383**



<b>FB81</b>		<b>OR240</b>
Lunghezza/Lenght	AKRON	Accessori/Features
275	81018	-

**Figura 384**



<b>FB85</b>		<b>MC49</b>
Lunghezza/Lenght	AKRON	Accessori/Features
205	80620	-
360	80607	-

**Figura 385**



<b>FB86</b>		<b>MC59</b>
Lunghezza/Lenght	AKRON	Accessori/Features
550	80595	(1)C87-(1)C27-(1)C14

**Figura 386**



<b>FB86</b>		<b>MC62</b>
Lunghezza/Lenght	AKRON	Accessori/Features
560	80596	(1)C4

**Figura 387**



<b>FB87</b>		<b>FB87</b>
Lunghezza/Lenght	AKRON	Accessori/Features
440	80429	-

**Figura 388**



<b>FB88</b>		<b>FB88</b>
Lunghezza/Lenght	AKRON	Accessori/Features
230	80437	-

**Figura 389**



<b>FB89</b>		<b>OR21</b>
Lunghezza/Lenght	AKRON	Accessori/Features
480	80443	(1)C81
555	80959	(1)C69
555	8960	(1)C69

**Figura 390**



<b>FB89</b>		<b>OR118</b>
Lunghezza/Lenght	AKRON	Accessori/Features
495	80447	(1)C50

**Figura 391**



	<b>FB92</b>	<b>OR192</b>	
Lunghezza/Lenght	AKRON	Accessori/Features	
640	80688	(1)C75	

**Figura 392**



	<b>FB92</b>	<b>OR252</b>	
Lunghezza/Lenght	AKRON	Accessori/Features	
575	80936	(1)C75	

**Figura 393**



	<b>FB94</b>	<b>OR88</b>	
Lunghezza/Lenght	AKRON	Accessori/Features	
-	80636	-	

**Figura 394**



	<b>FB95</b>	<b>FC9</b>	
Lunghezza/Lenght	AKRON	Accessori/Features	
420	80036	-	

**Figura 395**



	<b>FB97</b>	<b>FB97</b>	
Lunghezza/Lenght	AKRON	Accessori/Features	
280	80699	-	
320	80649	-	

**Figura 396**



	<b>FB97</b>	<b>OR107</b>	
Lunghezza/Lenght	AKRON	Accessori/Features	
265	80891	-	

**Figura 397**



	<b>FB98</b>	<b>OR31</b>	
Lunghezza/Lenght	AKRON	Accessori/Features	
310	80784	-	
310	80785	-	
500	80984	(1)C71	

**Figura 398**



	<b>FB98</b>	<b>OR42</b>	
Lunghezza/Lenght	AKRON	Accessori/Features	
535	80782	(1)C134-(1)C27	
535	80783	(1)C132-(1)C27	
540	80909	(1)C134-(1)C27	
540	80910	(1)C132-(1)C27	

**Figura 399**



	<b>FB98</b>	<b>OR105</b>	
Lunghezza/Lenght	AKRON	Accessori/Features	
555	80682	(1)C70	

**Figura 400**



	<b>FB98</b>	<b>OR170</b>	
Lunghezza/Lenght	AKRON	Accessori/Features	
485	80642	(1)C71	



**Tubi flessibili per freno**  
**suddivisi per tipo ed elencati**  
**in ordine progressivo dimensionale**

**Figura 401**



<b>FB98</b>		<b>OR203</b>
Lunghezza/Lenght	AKRON	Accessori/Features
410	<b>80903</b>	(1)C71-(1)C27
410	<b>80904</b>	(1)C71-(1)C27
485	<b>80778</b>	(1)C146-(1)C25
485	<b>80779</b>	(1)C144-(1)C145

**Figura 402**



<b>FB98</b>		<b>OR217</b>
Lunghezza/Lenght	AKRON	Accessori/Features
505	<b>80772</b>	(1)C127
505	<b>80773</b>	(1)C135

**Figura 403**



<b>FB98</b>		<b>OR224</b>
Lunghezza/Lenght	AKRON	Accessori/Features
485	<b>80643</b>	(1)C71

**Figura 404**



<b>FB98</b>		<b>OR227</b>
Lunghezza/Lenght	AKRON	Accessori/Features
555	<b>80924</b>	(1)C71-(1)C27
675	<b>80681</b>	(1)C70

**Figura 405**



<b>FB98</b>		<b>OR230</b>
Lunghezza/Lenght	AKRON	Accessori/Features
630	<b>80663</b>	(1)C70-(1)C29-(2)C7
630	<b>80664</b>	(1)C70-(1)C29-(2)C7

**Figura 406**



<b>FB98</b>		<b>OR247</b>
Lunghezza/Lenght	AKRON	Accessori/Features
520	<b>80905</b>	(1)C131-(1)C27
560	<b>81049</b>	(1)C142

**Figura 407**



<b>FB98</b>		<b>OR248</b>
Lunghezza/Lenght	AKRON	Accessori/Features
555	<b>80913</b>	(1)C131

**Figura 408**



<b>FB98</b>		<b>OR250</b>
Lunghezza/Lenght	AKRON	Accessori/Features
555	<b>80914</b>	(1)C138

**Figura 409**



<b>FB98</b>		<b>OR251</b>
Lunghezza/Lenght	AKRON	Accessori/Features
520	<b>80906</b>	(1)C137-(1)C27
555	<b>81050</b>	(1)C143

**Figura 410**



<b>FB98</b>		<b>OR257</b>
Lunghezza/Lenght	AKRON	Accessori/Features
285	<b>80780</b>	-

**Figura 411**



	<b>FB98</b>	<b>OR258</b>
Lunghezza/Lenght	AKRON	Accessori/Features
290	80781	(1)C27

**Figura 412**



	<b>FB98</b>	<b>OR259</b>
Lunghezza/Lenght	AKRON	Accessori/Features
540	80791	(1)C140

**Figura 413**



	<b>FB98</b>	<b>OR260</b>
Lunghezza/Lenght	AKRON	Accessori/Features
195	80792	(1)C26
195	80793	-

**Figura 414**



	<b>FB98</b>	<b>OR261</b>
Lunghezza/Lenght	AKRON	Accessori/Features
565	81043	(1)C141-(1)C25

**Figura 415**



	<b>FB98</b>	<b>OR262</b>
Lunghezza/Lenght	AKRON	Accessori/Features
575	80794	(1)C141-(1)C25

**Figura 416**



	<b>FB103</b>	<b>OR228</b>
Lunghezza/Lenght	AKRON	Accessori/Features
340	80715	-

**Figura 417**



	<b>FB105</b>	<b>OR226</b>
Lunghezza/Lenght	AKRON	Accessori/Features
340	80709	-



**Figura 418**



	<b>FB105</b>	<b>OR228</b>
Lunghezza/Lenght	AKRON	Accessori/Features
340	80710	-

**Figura 419**



	<b>FB108</b>	<b>FB108</b>	
Lunghezza/Lenght	AKRON	Accessori/Features	
300	80937	-	
415	80926	-	

**Figura 420**



	<b>FB108</b>	<b>OR108</b>
Lunghezza/Lenght	AKRON	Accessori/Features
345	80685	-
345	80686	-

**Tubi flessibili per freno**  
**suddivisi per tipo ed elencati**  
**in ordine progressivo dimensionale**

**Figura 421**



<b>FB108</b>		<b>OR158</b>
Lunghezza/Lenght	AKRON	Accessori/Features
515	80927	(1)C75
610	80815	(1)C75
635	80687	(1)C75

**Figura 422**



<b>FB108</b>		<b>OR173</b>
Lunghezza/Lenght	AKRON	Accessori/Features
645	80931	(1)C75

**Figura 423**



<b>FB108</b>		<b>OR192</b>
Lunghezza/Lenght	AKRON	Accessori/Features
515	80928	(1)C75

**Figura 424**



<b>FB108</b>		<b>OR199</b>
Lunghezza/Lenght	AKRON	Accessori/Features
210	80933	-
220	80817	-
255	80689	-
495	80929	(1)C75

**Figura 425**



<b>FB108</b>		<b>OR200</b>
Lunghezza/Lenght	AKRON	Accessori/Features
210	80934	-
225	80818	-
495	80930	(1)C75

**Figura 426**



<b>FB108</b>		<b>OR232</b>
Lunghezza/Lenght	AKRON	Accessori/Features
575	80935	(1)C75

**Figura 427**



<b>FB109</b>		<b>OR98</b>
Lunghezza/Lenght	AKRON	Accessori/Features
235	80919	-

**Figura 428**



<b>FB110</b>		<b>FB110</b>
Lunghezza/Lenght	AKRON	Accessori/Features
260	81017	-

**Figura 429**



<b>FB112</b>		<b>OR203</b>
Lunghezza/Lenght	AKRON	Accessori/Features
485	80659	(1)C149-(1)C14
485	80660	(1)C147-(1)C14

**Figura 430**



<b>FB112</b>		<b>OR242</b>
Lunghezza/Lenght	AKRON	Accessori/Features
500	80661	(1)C148
500	80662	(1)C129

**Figura 431**



<b>FB113</b>		<b>OR31</b>
Lunghezza/Lenght	AKRON	Accessori/Features
310	80911	-
310	80912	-

**Figura 432**



<b>FB113</b>		<b>OR244</b>
Lunghezza/Lenght	AKRON	Accessori/Features
345	80916	-

**Figura 433**



<b>FB113</b>		<b>OR245</b>
Lunghezza/Lenght	AKRON	Accessori/Features
345	80915	-

**Figura 434**



<b>FB114</b>		<b>FB114</b>
Lunghezza/Lenght	AKRON	Accessori/Features
200	81009	-
285	80701	-

**Figura 435**



<b>FB114</b>		<b>OR127</b>
Lunghezza/Lenght	AKRON	Accessori/Features
335	80706	-
640	81007	(1)C69-(1)C126
640	81008	(1)C69-(1)C126
690	80650	(1)C125-(1)C119
690	80651	(1)C120-(1)C116
735	80886	(1)C120-(1)C116
735	80887	(1)C125-(1)C119

**Figura 436**



<b>FB114</b>		<b>OR241</b>
Lunghezza/Lenght	AKRON	Accessori/Features
300	80652	-

**Figura 437**



<b>FB114</b>		<b>OR242</b>
Lunghezza/Lenght	AKRON	Accessori/Features
300	80653	-

**Figura 438**



<b>FB115</b>		<b>OR22</b>
Lunghezza/Lenght	AKRON	Accessori/Features
650	81066	(1)C115-(2)C66

**Figura 439**



<b>FB116</b>		<b>FB116</b>
Lunghezza/Lenght	AKRON	Accessori/Features
225	81062	-
285	81063	-

**Figura 440**





<b>FC</b>		<b>OR1</b>
Lunghezza/Lenght	AKRON	Accessori/Features
340	8544	(1)C14

*Tubi flessibili per freno  
suddivisi per tipo ed elencati  
in ordine progressivo dimensionale*

**Figura 441**



	<b>FC1</b>	<b>FC5</b>	
Lunghezza/Lenght	<b>AKRON</b>	Accessori/Features	
413	<b>80075</b>	-	

**Figura 442**



	<b>FC2</b>	<b>OR1</b>	
Lunghezza/Lenght	<b>AKRON</b>	Accessori/Features	
325	<b>8549</b>	(1)C14	

**Figura 443**



	<b>FC10</b>	<b>OR51</b>	
Lunghezza/Lenght	<b>AKRON</b>	Accessori/Features	
545	<b>80976</b>	(1)C81	

**Figura 444**



	<b>FC10</b>	<b>OR150</b>	
Lunghezza/Lenght	<b>AKRON</b>	Accessori/Features	
545	<b>80977</b>	(1)C81	



**Figura 445**



	<b>FC10</b>	<b>OR194</b>	
Lunghezza/Lenght	<b>AKRON</b>	Accessori/Features	
560	<b>80972</b>	(1)C81	



**Figura 446**



	<b>FC10</b>	<b>OR198</b>	
Lunghezza/Lenght	<b>AKRON</b>	Accessori/Features	
565	<b>80973</b>	(1)C81	



**Figura 447**



	<b>FP1</b>	<b>OR12</b>	
Lunghezza/Lenght	<b>AKRON</b>	Accessori/Features	
315	<b>80231</b>	(1)C17	
405	<b>8583</b>	(1)C39	
450	<b>8578</b>	(1)C36	



**Figura 448**



	<b>FP2</b>	<b>OR11</b>	
Lunghezza/Lenght	<b>AKRON</b>	Accessori/Features	
315	<b>80233</b>	(1)C17	
405	<b>8582</b>	(1)C38	
450	<b>8579</b>	(1)C37	

**Figura 449**



	<b>FP6</b>	<b>OR133</b>	
Lunghezza/Lenght	<b>AKRON</b>	Accessori/Features	
460	<b>80031</b>	(1)C14-(1)C17	

**Figura 450**



<b>FP7</b>		<b>OR132</b>
Lunghezza/Lenght	AKRON	Accessori/Features
460	<b>80032</b>	(1)C14-(1)C17

**Figura 451**



<b>FZ</b>		<b>FB23</b>
Lunghezza/Lenght	AKRON	Accessori/Features
235	<b>80441</b>	-

**Figura 452**



<b>FZ</b>		<b>FB60</b>
Lunghezza/Lenght	AKRON	Accessori/Features
210	<b>80309</b>	-

**Figura 453**



<b>FZ</b>		<b>FZ</b>
Lunghezza/Lenght	AKRON	Accessori/Features
160	<b>80938</b>	-
210	<b>80747</b>	-
213	<b>80214</b>	-
215	<b>8535</b>	(1)C26
215	<b>8944</b>	-
220	<b>8516</b>	-
220	<b>8518</b>	(1)C26
230	<b>80201</b>	-
235	<b>8576</b>	-
245	<b>8635</b>	-
260	<b>80006</b>	(1)C27
270	<b>8501</b>	-
275	<b>8573</b>	(1)C26
280	<b>8495</b>	-

**segue Figura 453**

<b>FZ</b>		<b>FZ</b>
Lunghezza/Lenght	AKRON	Accessori/Features
285	<b>8446</b>	-
305	<b>8444</b>	-
325	<b>8603</b>	-

**Figura 454**



<b>FZ</b>		<b>MC11</b>
Lunghezza/Lenght	AKRON	Accessori/Features
180	<b>8632</b>	-
228	<b>80204</b>	(1)C26
250	<b>80252</b>	(1)C26
267	<b>8445</b>	-
270	<b>8496</b>	-
270	<b>80207</b>	-
290	<b>8494</b>	-
310	<b>8640</b>	-
315	<b>8515</b>	(1)C27
315	<b>8638</b>	(1)C14
325	<b>8317</b>	-
325	<b>8570</b>	(1)C27
330	<b>8443</b>	-
345	<b>8498</b>	-
345	<b>8636</b>	(1)C27-(1)C14
350	<b>8497</b>	-
355	<b>8620</b>	(1)C27
355	<b>80211</b>	(1)C16-(1)C27-(1)C26
360	<b>8942</b>	-
360	<b>8943</b>	-
375	<b>8500</b>	-
385	<b>8577</b>	(1)C27-(1)C7
400	<b>8566</b>	(1)C14
405	<b>81004</b>	(1)C5
410	<b>8499</b>	-
410	<b>8639</b>	(1)C7
415	<b>80200</b>	(1)C18-(1)C7
420	<b>8633</b>	(1)C7
420	<b>8922</b>	(1)C14
430	<b>8641</b>	(2)C14
433	<b>80208</b>	(1)C25-(1)C14
435	<b>8536</b>	-

**Tubi flessibili per freno**  
**suddivisi per tipo ed elencati**  
**in ordine progressivo dimensionale**

**segue Figura 454**

	<b>FZ</b>	<b>MC11</b>
Lunghezza/Lenght	AKRON	Accessori/Features
440	<b>80666</b>	(1)C5
445	<b>80440</b>	(1)C14-(1)C7-(1)C13
445	<b>8940</b>	(2)C18-(1)C14
450	<b>80159</b>	(1)C27-(1)C14-(1)C5
455	<b>80846</b>	(1)C5
457	<b>80213</b>	(1)C27-(1)C5
460	<b>8547</b>	(1)C27-(1)C7
465	<b>8485</b>	(1)C27-(1)C7
465	<b>80835</b>	(1)C110-(1)C112-(1)C7-(1)C14
465	<b>81032</b>	(1)C109-(1)C110-(1)C7-(1)C4
480	<b>8631</b>	(1)C7
480	<b>80003</b>	(1)C27-(1)C7
480	<b>80212</b>	(1)C5
484	<b>80519</b>	(1)C27-(1)C7
490	<b>80007</b>	(1)C27-(1)C14-(1)C5
515	<b>80746</b>	(1)C5-(1)C16
525	<b>80741</b>	(1)C111-(1)C7-(1)C24
535	<b>8625</b>	(1)C27-(1)C14-(1)C7
540	<b>80257</b>	(1)C18-(1)C7
562	<b>80205</b>	(1)C14-(1)C7-(3)C24
575	<b>80265</b>	(1)C26-(1)C7-(2)C3
580	<b>80005</b>	(1)C27-(1)C7
582	<b>80206</b>	(2)C27-(1)C14
600	<b>80203</b>	(1)C14-(1)C7-(1)C24
620	<b>81005</b>	(1)C5

**Figura 455**



	<b>FZ</b>	<b>MC22</b>
Lunghezza/Lenght	AKRON	Accessori/Features
357	<b>8422</b>	-

**Figura 456**



	<b>FZ</b>	<b>MG1</b>
Lunghezza/Lenght	AKRON	Accessori/Features
515	<b>8569</b>	(1)C27-(1)C14-(1)C5

**Figura 457**



	<b>FZ</b>	<b>MG11</b>
Lunghezza/Lenght	AKRON	Accessori/Features
570	<b>80384</b>	(1)C63-(1)C7
615	<b>80385</b>	(1)C7

**Figura 458**



	<b>FZ</b>	<b>MG12</b>
Lunghezza/Lenght	AKRON	Accessori/Features
510	<b>80588</b>	(1)C63-(1)C7

**Figura 459**



	<b>FZ</b>	<b>MG15</b>
Lunghezza/Lenght	AKRON	Accessori/Features
535	<b>80587</b>	(1)C25-(1)C7

**Figura 460**



	<b>FZ</b>	<b>MP6</b>
Lunghezza/Lenght	AKRON	Accessori/Features
295	<b>8379</b>	-

**Figura 461**



	<b>FZ</b>	<b>OR</b>
Lunghezza/Lenght	AKRON	Accessori/Features
385	<b>8380</b>	-

**Figura 462**



<b>FZ</b>		<b>OR30</b>	
Lunghezza/Lenght	AKRON	Accessori/Features	
495	<b>80841</b>	(1)C7	

**Figura 463**



<b>FZ</b>		<b>OR115</b>	
Lunghezza/Lenght	AKRON	Accessori/Features	
555	<b>80840</b>	(1)C7-(1)C14-(2)C114	

**Figura 464**



<b>FZ1</b>		<b>FZ1</b>	
Lunghezza/Lenght	AKRON	Accessori/Features	
255	<b>8561</b>	-	

**Figura 465**



<b>FZ1</b>		<b>MC11</b>	
Lunghezza/Lenght	AKRON	Accessori/Features	
325	<b>8622</b>	(1)C26-(1)C14	
545	<b>8627</b>	(1)C27-(1)C14-(1)C7	

**Figura 466**



<b>FZ1</b>		<b>MG1</b>	
Lunghezza/Lenght	AKRON	Accessori/Features	
460	<b>8534</b>	(1)C27-(1)C7	
510	<b>8533</b>	(1)C14-(1)C7	
565	<b>8939</b>	(1)C14-(1)C7-(2)C24	

**Figura 467**



<b>FZ2</b>		<b>FZ2</b>	
Lunghezza/Lenght	AKRON	Accessori/Features	
190	<b>8637</b>	-	
220	<b>80319</b>	-	
270	<b>80318</b>	(1)C16	
380	<b>80329</b>	(1)C16	

**Figura 468**



<b>FZ2</b>		<b>MG9</b>	
Lunghezza/Lenght	AKRON	Accessori/Features	
510	<b>80361</b>	(1)C73-(1)C14-(1)C24-(1)C23	
530	<b>80349</b>	(1)C73-(1)C14-(1)C24	

**Figura 469**



<b>FZ3</b>		<b>FZ3</b>	
Lunghezza/Lenght	AKRON	Accessori/Features	
290	<b>80811</b>	-	

**Figura 470**



<b>FZ3</b>		<b>MC11</b>	
Lunghezza/Lenght	AKRON	Accessori/Features	
485	<b>80563</b>	(1)C82	

**Figura 471**



<b>FZ4</b>		<b>FZ4</b>	
Lunghezza/Lenght	AKRON	Accessori/Features	
185	<b>80744</b>	-	
265	<b>80749</b>	(1)C16	



**Tubi flessibili per freno**  
suddivisi per tipo ed elencati  
in ordine progressivo dimensionale

**Figura 472**



	<b>FZ4</b>	<b>MG8</b>
Lunghezza/Lenght	AKRON	Accessori/Features
470	80843	(1)C66-(1)C108-(1)C60

**Figura 473**



	<b>FZ4</b>	<b>MG9</b>
Lunghezza/Lenght	AKRON	Accessori/Features
510	80748	(1)C73-(1)C114-(1)C14-(1)C23

**Figura 474**



	<b>MC</b>	<b>MC</b>
Lunghezza/Lenght	AKRON	Accessori/Features
420	8000	-
470	8001	-

**Figura 475**



	<b>MC</b>	<b>MC21</b>
Lunghezza/Lenght	AKRON	Accessori/Features
545	8276	-

**Figura 476**



	<b>MC1</b>	<b>MF</b>
Lunghezza/Lenght	AKRON	Accessori/Features
312	8003	-
450	8060	-

**Figura 477**



	<b>MC1</b>	<b>MF4</b>
Lunghezza/Lenght	AKRON	Accessori/Features
327	8076	-

**Figura 478**



	<b>MC4</b>	<b>MC4</b>
Lunghezza/Lenght	AKRON	Accessori/Features
208	8131	-
390	8024	-
465	8453	-

**Figura 479**



	<b>MC4</b>	<b>MF6</b>
Lunghezza/Lenght	AKRON	Accessori/Features
425	8455	-

**Figura 480**



	<b>MC4</b>	<b>MP4</b>
Lunghezza/Lenght	AKRON	Accessori/Features
380	8025	-

**Figura 481**



	<b>MC11</b>	<b>MC11</b>
Lunghezza/Lenght	AKRON	Accessori/Features
390	80625	-

**Figura 482**



<b>MC11</b>		<b>MC22</b>
Lunghezza/Lenght	AKRON	Accessori/Features
180	8525	-
195	8473	-
265	8224	-
270	8209	(1)C14
300	8396	(1)C27
325	8474	(1)C27-(1)C14
375	8205	(1)C14
375	8461	(1)C14-(1)C6
385	8460	(1)C6
395	8524	-
435	8456	-
435	8605	(1)C16-(1)C26-(1)C6
450	8420	(1)C11-(1)C24
450	8421	(1)C11-(2)C23
450	8587	(1)C27-(1)C6
480	8419	(1)C11-(1)C24
490	8580	(1)C16-(1)C26-(1)C6
495	8581	(1)C16-(1)C26-(1)C6

**Figura 483**



<b>MC11</b>		<b>MC40</b>
Lunghezza/Lenght	AKRON	Accessori/Features
355	8600	-

**Figura 484**



<b>MC11</b>		<b>MC42</b>
Lunghezza/Lenght	AKRON	Accessori/Features
335	8585	(1)C14
335	8607	-
365	80191	(1)C16
365	8922	(1)C27-(1)C14
390	8612	(1)C16-(1)C17
440	8584	(1)C27-(1)C14

**Figura 485**



<b>MC11</b>		<b>MC45</b>
Lunghezza/Lenght	AKRON	Accessori/Features
580	8648	(2)C3-(1)C4

**Figura 486**



<b>MC11</b>		<b>MF17</b>
Lunghezza/Lenght	AKRON	Accessori/Features
495	8623	(2)C23
535	8621	(3)C23

**Figura 487**



<b>MC14</b>		<b>MF3</b>
Lunghezza/Lenght	AKRON	Accessori/Features
450	8277	-
495	8278	-

**Figura 488**



<b>MC14</b>		<b>MF8</b>
Lunghezza/Lenght	AKRON	Accessori/Features
437	8157	-
495	8156	-

**Figura 489**



<b>MC14</b>		<b>MF9</b>
Lunghezza/Lenght	AKRON	Accessori/Features
495	8307	-
590	8288	-
600	8306	-

**Figura 490**



**MC14**

**OR14**

Lunghezza/Lenght	AKRON	Accessori/Features
397	8286	-

**Figura 491**



**MC15**

**MC18**

Lunghezza/Lenght	AKRON	Accessori/Features
307	8146	-

**Figura 492**



**MC22**

**MC22**

Lunghezza/Lenght	AKRON	Accessori/Features
205	8472	-
270	8225	-
280	8200	-
370	8202	(1)C25
370	8283	-
445	80269	(1)C27-(2)C14
445	8376	(1)C14-(1)C12
470	8454	(1)C25-(1)C14
485	8203	(1)C14
485	8204	(1)C14

**Figura 493**



**MC22**

**MC59**

Lunghezza/Lenght	AKRON	Accessori/Features
350	80397	(1)C25
435	80341	(1)C63

**Figura 494**



**MC22**

**MP17**

Lunghezza/Lenght	AKRON	Accessori/Features
273	8377	-
380	8342	-
387	8284	-
460	8341	-
490	8340	-
535	8339	-

**Figura 495**



**MC22**

**OR2**

Lunghezza/Lenght	AKRON	Accessori/Features
295	8514	-

**Figura 496**



**MC24**

**MC27**

Lunghezza/Lenght	AKRON	Accessori/Features
610	8285	-

**Figura 497**



**MC26**

**MC27**

Lunghezza/Lenght	AKRON	Accessori/Features
640	8300	-

**Figura 498**



**MC26**

**OR14**

Lunghezza/Lenght	AKRON	Accessori/Features
270	8302	-

**Figura 499**



**MC27**

**MF9**



Lunghezza/Lenght	AKRON	Accessori/Features
600	8334	-
630	8348	-
850	8366	(1)C11

**Figura 500**



**MC30**

**MF9**



Lunghezza/Lenght	AKRON	Accessori/Features
555	8344	-

**Figura 501**



**MC39**

**MC40**

Lunghezza/Lenght	AKRON	Accessori/Features
225	8463	(1)C24
250	8462	(1)C24

**Figura 502**



**MC39/1**

**MC39/1**

Lunghezza/Lenght	AKRON	Accessori/Features
360	8586	-

**Figura 503**



**MC39/1**

**OR11**

Lunghezza/Lenght	AKRON	Accessori/Features
470	8556	(1)C26-(1)C35
470	8558	(1)C26-(1)C37

**Figura 504**



**MC39/1**

**OR12**

Lunghezza/Lenght	AKRON	Accessori/Features
470	8555	(1)C26-(1)C35
470	8557	(1)C26-(1)C36

**Figura 505**



**MC40**

**MC40**

Lunghezza/Lenght	AKRON	Accessori/Features
340	8565	(1)C16
435	8689	(1)C14

**Figura 506**



**MC40**

**MG1**

Lunghezza/Lenght	AKRON	Accessori/Features
415	8604	(1)C26-(1)C40
415	8687	(1)C26-(1)C41
525	80190	(1)C27-(1)C67
535	8610	(1)C27-(1)C6

**Figura 507**



**MC45**

**MC55**

Lunghezza/Lenght	AKRON	Accessori/Features
575	80307	(2)C3-(1)C4

**Figura 508**



**MC46**

**MC47**

Lunghezza/Lenght	AKRON	Accessori/Features
335	8690	-

*Tubi flessibili per freno  
suddivisi per tipo ed elencati  
in ordine progressivo dimensionale*

**Figura 509**



	<b>MF</b>	<b>MF</b>	
Lunghezza/Lenght	<b>AKRON</b>	Accessori/Features	
224	<b>8021</b>	-	
450	<b>8059</b>	-	

**Figura 510**



	<b>MF</b>	<b>OR</b>	
Lunghezza/Lenght	<b>AKRON</b>	Accessori/Features	
310	<b>8020</b>	-	
381	<b>8028</b>	-	
406	<b>8023</b>	-	
441	<b>8031</b>	-	

**Figura 511**



	<b>MF1</b>	<b>MP</b>	
Lunghezza/Lenght	<b>AKRON</b>	Accessori/Features	
450	<b>8032</b>	-	

**Figura 512**



	<b>MF3</b>	<b>MP7</b>	
Lunghezza/Lenght	<b>AKRON</b>	Accessori/Features	
455	<b>8063</b>	-	
495	<b>8064</b>	-	

**Figura 513**



	<b>MF4</b>	<b>OR</b>	
Lunghezza/Lenght	<b>AKRON</b>	Accessori/Features	
405	<b>8270</b>	-	

**Figura 514**



	<b>MF6</b>	<b>MP6</b>	
Lunghezza/Lenght	<b>AKRON</b>	Accessori/Features	
312	<b>8130</b>	-	
330	<b>8145</b>	-	

**Figura 515**



	<b>MF6/1</b>	<b>MF6/1</b>	
Lunghezza/Lenght	<b>AKRON</b>	Accessori/Features	
247	<b>8505</b>	-	
470	<b>8503</b>	-	

**Figura 516**



	<b>MF6/1</b>	<b>MP6</b>	
Lunghezza/Lenght	<b>AKRON</b>	Accessori/Features	
340	<b>8245</b>	-	

**Figura 517**



	<b>MF8</b>	<b>MF8</b>	
Lunghezza/Lenght	<b>AKRON</b>	Accessori/Features	
320	<b>8296</b>	-	

**Figura 518**



	<b>MF9</b>	<b>OR9</b>	
Lunghezza/Lenght	<b>AKRON</b>	Accessori/Features	
245	<b>8335</b>	-	

**Figura 519**



	<b>MF9</b>	<b>OR14</b>
Lunghezza/Lenght	AKRON	Accessori/Features
245	8336	-

**Figura 520**



	<b>MF10</b>	<b>MF10</b>
Lunghezza/Lenght	AKRON	Accessori/Features
330	8294	-
505	8298	-
510	8292	-

**Figura 521**



	<b>MF10</b>	<b>MP7</b>
Lunghezza/Lenght	AKRON	Accessori/Features
487	8293	-
517	8299	-

**Figura 522**



	<b>MF12</b>	<b>MF12</b>
Lunghezza/Lenght	AKRON	Accessori/Features
325	8312	-

**Figura 523**



	<b>MF13</b>	<b>MF13</b>
Lunghezza/Lenght	AKRON	Accessori/Features
292	8326	-

**Figura 524**



	<b>MF17</b>	<b>MF17</b>
Lunghezza/Lenght	AKRON	Accessori/Features
327	8449	-

**Figura 525**



	<b>MF17</b>	<b>MP17</b>
Lunghezza/Lenght	AKRON	Accessori/Features
385	8624	-
493	8450	(2)C23
533	8451	-



**C1**



**C2**



**C3**



**C4**



**C5**



**C6**



**C7**



**C8**



**C9**



**C10**



**C11**



**C12**



**C13**



**C14**



**C15**



**C16**



**C17**



**C18**



**C19**



**C20**



**C21**



**C22**



**C23**



**C24**

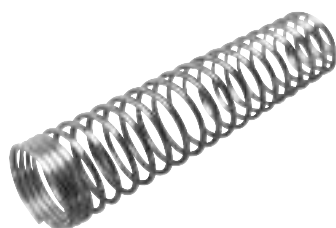

**C25**

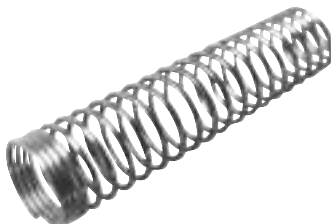

**C26**

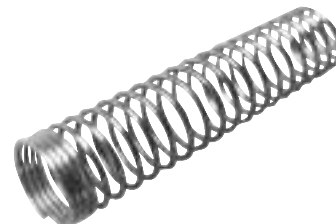

**C27**



**C28**



**C29**



**C30**





**C31**



**C32**



**C33**



**C34**



**C35**



**C36**



**C37**



**C38**



**C39**

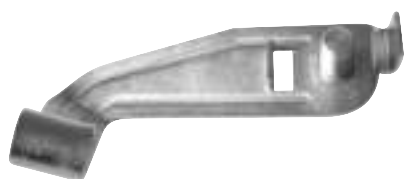

**C40**

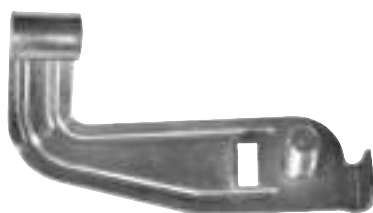

**C41**



**C42**

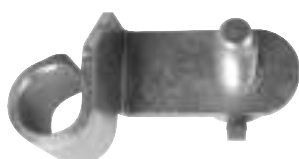

**C43**



**C44**



**C45**



**C46**



**C47**



**C48**

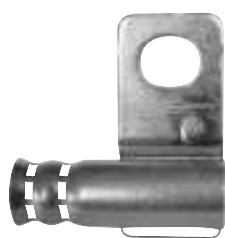

**C49**



**C50**



**C51**



**C52**



**C53**



**C54**



**C55**



**C56**

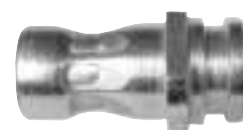

**C57**



**C58**



**C59**



**C60**



**C61**



**C62**

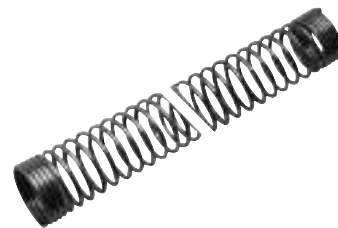

**C63**

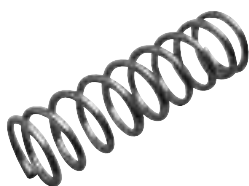

**C64**



**C65**



**C66**



**C67**



**C68**



**C69**



**C70**



**C71**



**C72**



**C73**



**C74**



**C75**



**C76**



**C77**



**C78**



**C79**



**C80**



**C81**



**C82**



**C83**



**C84**

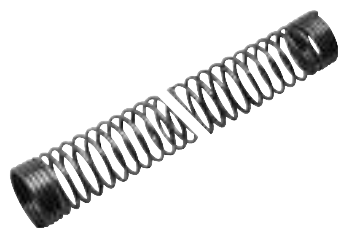

**C85**



**C86**



**C87**



**C88**

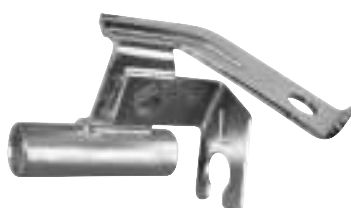

**C89**



**C90**



**C91**



**C92**



**C93**



**C94**



**C95**



**C96**



**C97**



**C98**



**C99**



**C100**

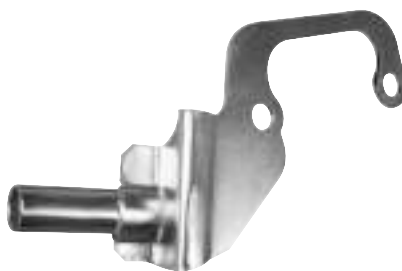

**C101**



**C102**



**C103**



**C104**



**C105**



**C106**



**C107**



**C108**



**C109**



**C110**

**271029**

**271030**



**C112**

**C113**



**C114**

**RC42**



**C115**

**C116**



**C117**



**C118**



**C119**



**C120**



**C121**



**C122**



**C123**



**C124**



**C125**



**C126**



**C127**



**C128**



**C129**



**C130**



**C131**



**C132**



**C133**



**C134**



**C135**



**C136**

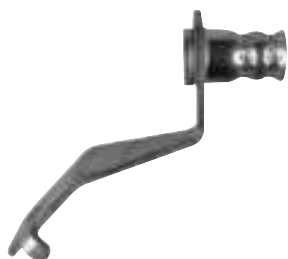

**C137**



**C138**



**C139**



**C140**



**C141**



**C142**

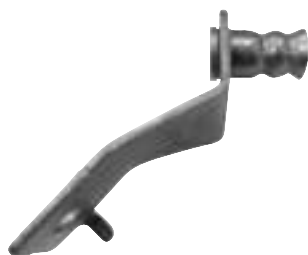

**C143**



**C144**



**C145**



**C146**



**C147**



**C148**



**C149**



**C150**



*Componenti tubi freno*





# Tubi flessibili per Freno e Frizione



Catalogo



01  
13



Lista numerica tubi freno







	Costruttore Car Manufacturers		N° Figura Drawing N°
<b>8000</b>	IVECO/OM	Leoncino (CO1D)	474
	IVECO/OM	Leoncino (CO1D)	474
	IVECO/OM	Tigrotto (CO1D)	474
	IVECO/OM	Tigrotto (CO1D)	474
<b>8001</b>	FIAT VI	645N, N1, N2, N3 - 650N, N1, N2, N3 - 650E, E1 - 655N, N1 - 662N, N1, N2, N3 - 672N - 673 N	474
	FIAT VI	645N, N1, N2, N3 - 650N, N1, N2, N3 - 650E, E1 - 655N, N1 - 662N, N1, N2, N3 - 672N - 673 N	474
	IVECO/OM	120	474
<b>8003</b>	FIAT	1100/103	476
	FIAT VI	615N,N1 - 616N,N1,N2,N2/4,N3, N3/N4 - 625N,N1,N2,N3	476
<b>8008</b>	SKODA	105/120/130/136	162
	SKODA	RAPID	162
<b>8009</b>	SKODA	105/120/130/136	162
	SKODA	RAPID	162
<b>8010</b>	SKODA	FAVORIT	158
<b>8011</b>	MERCEDES	CLASSE C (W202)	62
	MERCEDES	CLASSE C (W203)	62
	MERCEDES	CLASSE C (W204)	62
	MERCEDES	CLASSE CLK (C208)	62
	MERCEDES	CLASSE CLK (C209)	62
	MERCEDES	CLASSE E (W210)	62
	MERCEDES	CLASSE SLK (R170)	62
<b>8013</b>	MERCEDES	207 D	36
	MERCEDES	407 D	36
<b>8014</b>	MERCEDES	MB 100 D	107
<b>8015</b>	VOLVO	440-460	40
	VOLVO	480	40
<b>8016</b>	FIAT	X 1/9	125
<b>8017</b>	FIAT	X 1/9	124
<b>8019</b>	FIAT	125	122
	FIAT COMM	241	122
	LADA	1200, 1300, 1500, 1600	122
	LADA	NIVA	122
	LADA	NOVA	122
	POLSKI	125-P	122
<b>8020</b>	FIAT	600 D-E	510
<b>8021</b>	FIAT	600 D-E	509
	FIAT	600 DM-T	509
<b>8023</b>	FIAT	1100/103	510
<b>8024</b>	ALFA ROMEO	2000	478
	ALFA ROMEO	GIULIA	478
	ALFA ROMEO	SPIDER (1750 - 2000)	478
<b>8025</b>	ALFA ROMEO	2000	480
	ALFA ROMEO	GIULIA	480
	ALFA ROMEO	SPIDER (1750 - 2000)	480

	Costruttore Car Manufacturers		N° Figura Drawing N°
<b>8026</b>	FIAT	500	103
<b>8027</b>	FIAT	500	100
<b>8028</b>	FIAT VI	615N,N1 - 616N,N1,N2,N2/4,N3, N3/N4 - 625N,N1,N2,N3	510
<b>8029</b>	CITROEN	BX	235
<b>8030</b>	AUDI	100 (90-94)	50
	AUDI	A6 (Mod.94)	50
<b>8031</b>	FIAT	600 DM-T	510
<b>8032</b>	LANCIA	APPIA II	511
	LANCIA	APPIA II	511
<b>8035</b>	AUDI	80 (09/86-08/91)	50
	AUDI	80 (09/91-12/94)	50
	AUDI	A4 (-09/01)	50
	AUDI	A6 (Mod.97)	50
	SKODA	SUPERB I (3U4)	50
	VW	PASSAT (3B2)	50
	VW	PASSAT (3B3)	50
<b>8036</b>	AUDI	80 (09/86-08/91)	40
	AUDI	90 (04/87-07/91)	40
	SEAT	CORDOBA (6K2/C2)	40
	SEAT	IBIZA II-III (6K1)	40
	VW	CORRADO	40
	VW	GOLF II	40
	VW	GOLF III	40
	VW	JETTA II	40
	VW	PASSAT (3A2, 35I)	40
	VW	POLO III (6N1, 6N2)	40
VW	VENTO	40	
<b>8037</b>	AUDI	80 (09/91-12/94)	40
<b>8038</b>	AUDI	80 (09/91-12/94)	50
	AUDI	80 (09/91-12/94)	50
<b>8039</b>	AUDI	100 (90-94)	40
<b>8041</b>	AUDI	80 (09/86-08/91)	36
<b>8043</b>	AUDI	A6 (Mod.94)	40
<b>8044</b>	FIAT	1800 B - 2300	101
<b>8046</b>	FIAT	1300 - 1500	102
<b>8047</b>	FIAT	1300 - 1500	101
<b>8049</b>	PORSCHE	928 S	105
	VW	TRANSPORTER T2	105
<b>8054</b>	FIAT	1800 B - 2300	102
<b>8055</b>	FIAT	1100 D	101
<b>8057</b>	VW	TRANSPORTER T4	50
<b>8059</b>	LANCIA	FULVIA	509
<b>8060</b>	LANCIA	FULVIA	476
<b>8061</b>	AUDI	A4 (-09/01)	50
	AUDI	A8 (Mod 2002)	50
	SKODA	SUPERB I (3U4)	50
	VW	PASSAT (3B2)	50
	VW	PASSAT (3B3)	50

	Costruttore Car Manufacturers		N° Figura Drawing N°
8062	AUDI	A4 (-09/01)	52
8063	IVECO/OM	Cerbiatto - Daino - Leoncino (CO2D)	512
	IVECO/OM	Tigrotto (CO2D)	512
8064	IVECO/OM	Cerbiatto - Daino - Leoncino (CO2D)	512
	IVECO/OM	Tigrotto (CO2D)	512
8065	FIAT	1100 D	103
8066	FIAT	850 Berlina	125
	FIAT	CROMA	125
8067	FIAT	850 Berlina	120
	FIAT	850 Berlina	120
8068	MERCEDES	CLASSE C (W202)	52
8069	ROVER	SERIE 200	184
	ROVER	SERIE 200	184
8070	ROVER	SERIE 200	183
	ROVER	SERIE 200	183
8072	FIAT	124	125
	FIAT	850 Berlina	125
8075	FIAT VI	615N,N1 - 616N,N1,N2,N2/4,N3, N3/N4 - 625N,N1,N2,N3	125
8076	FIAT VI	615N,N1 - 616N,N1,N2,N2/4,N3, N3/N4 - 625N,N1,N2,N3	477
	FIAT VI	615N,N1 - 616N,N1,N2,N2/4,N3, N3/N4 - 625N,N1,N2,N3	477
8078	ROVER	SERIE 400	183
	ROVER	SERIE 400	183
8083	FIAT	124	124
	FIAT	125	124
	FIAT	132	124
	POLSKI	125-P	124
8084	FIAT	1100 R	125
	FIAT COMM	238	125
8086	FIAT	124	120
	FIAT COMM	238	120
8093	HONDA	CIVIC IV	184
	HONDA	CIVIC V	184
	ROVER	SERIE 400	184
	ROVER	SERIE 400	184
8094	HONDA	CIVIC IV	184
	HONDA	CIVIC V	184
	ROVER	SERIE 400	184
	ROVER	SERIE 400	184
8095	TALBOT	SIMCA 1000	127
	TALBOT	SIMCA 1000	127
8096	RENAULT	R4	90
	RENAULT	R5	90
	RENAULT comm	R4 FURG	90
8097	RENAULT	R4	87
	RENAULT	R5	87
	RENAULT comm	R4 FURG	87



	Costruttore Car Manufacturers		N° Figura Drawing N°
8098	SAAB	9000	160
8099	SAAB	9000	160
8100	JEEP	WILLYS	87
8101	JEEP	WILLYS	89
8102	JEEP	WILLYS	89
8107	SUBARU	JUSTY I (KAD)	196
	SUBARU	JUSTY I (KAD)	196
8111	SUBARU	JUSTY I (KAD)	198
8113	DAIHATSU	APPLAUSE I-II	194
	DAIHATSU	CHARADE III	194
8114	TOYOTA	HILUX Pickup (_N_)	137
8130	INNOCENTI	MINI MINOR	514
8131	INNOCENTI	MINI MINOR	478
	INNOCENTI	90-120	478
	ROVER	METRO	478
8136	FIAT COMM	241	125
8138	FIAT	1100 R	122
8141	FIAT COMM	900 T - E	125
8142	FIAT	850 T	125
	FIAT COMM	900 T - E	125
8143	FIAT	126	120
	FIAT	500	120
	FIAT	850 T	120
	FIAT COMM	238	120
	FIAT COMM	900 T - E	120
	POLSKI	126-P	120
8144	FIAT	126	125
	FIAT	127 (1050, 1300 Sport)	125
	FIAT	500	125
	FIAT	RITMO	125
	FIAT COMM	FIORINO	125
	POLSKI	126-P	125
8145	INNOCENTI	MINI MINOR	514
	ROVER	METRO	514
8146	INNOCENTI	90-120	491
8156	FIAT VI	615N,N1 - 616N,N1,N2,N2/4,N3, N3/N4 - 625N,N1,N2,N3	488
	IVECO	40 NC - 40/35 NC	488
	IVECO/OM	LUPETTO	488
	IVECO/OM	LUPETTO	488
	IVECO/OM	Orsetto	488
8157	FIAT VI	615N,N1 - 616N,N1,N2,N2/4,N3, N3/N4 - 625N,N1,N2,N3	488
	IVECO	40 NC - 40/35 NC	488
	IVECO/OM	Orsetto	488
8172	VOLVO	440-460	40
	VOLVO	440-460	40
	VOLVO	480	40
8178	MERCEDES	200 (W114-115)	42



	Costruttore Car Manufacturers		N° Figura Drawing N°
<b>8178</b>	MERCEDES	CLASSE S (W116)	42
	MERCEDES	CLASSE SL (R107)	42
	MERCEDES	207 D	42
	MERCEDES	407 D	42
<b>8200</b>	FORD	CAPRI	492
	FORD	CORTINA	492
	FORD	ESCORT -80	492
	FORD	ESCORT -80	492
	FORD	TAUNUS	492
<b>8202</b>	FORD	TAUNUS	492
<b>8203</b>	FORD	CORTINA	492
	FORD	TAUNUS	492
<b>8204</b>	FORD	TAUNUS	492
<b>8205</b>	FORD	SIERRA	482
<b>8209</b>	FORD	ESCORT 80-86	482
	FORD	FIESTA 77-89	482
<b>8210</b>	OPEL	KADETT B	131
<b>8211</b>	OPEL	KADETT C	131
<b>8213</b>	OPEL	ASCONA B	129
<b>8214</b>	OPEL	ASCONA A	129
<b>8218</b>	OPEL	REKORD D	130
<b>8219</b>	OPEL	REKORD D	130
<b>8220</b>	OPEL	KADETT C	129
<b>8221</b>	OPEL	REKORD E	129
<b>8222</b>	FORD	FIESTA 77-89	199
<b>8223</b>	OPEL	ASCONA C	129
	OPEL	CORSA A	129
	OPEL	KADETT D	129
	OPEL	KADETT E	129
<b>8224</b>	SAAB	90	482
	SAAB	99	482
	SAAB	900	482
<b>8225</b>	SAAB	90	492
	SAAB	99	492
	SAAB	900	492
<b>8226</b>	AUDI	50	40
	BEDFORD	BRAVA 4x4	40
	VW	DERBY	40
	VW	POLO I-II (86, 86C, 80)	40
<b>8227</b>	AUDI	50	36
	AUDI	80 (- 08/86)	36
	AUDI	90 (- 03/87)	36
	AUDI	90 (04/87-07/91)	36
	AUDI	100 (82- 89)	36
	AUDI	100 (90-94)	36
	AUDI	A6 (Mod.94)	36
	VW	DERBY	36
	VW	PASSAT (32, 32B)	36
	VW	PASSAT (3A2, 35I)	36



	Costruttore Car Manufacturers		N° Figura Drawing N°
<b>8227</b>	VW	POLO I-II (86, 86C, 80)	36
<b>8228</b>	AUDI	80 (- 08/86)	40
	AUDI	80 (09/86-08/91)	40
	AUDI	90 (- 03/87)	40
	AUDI	90 (04/87-07/91)	40
	AUDI	100 (82- 89)	40
	VW	GOLF I	40
	VW	GOLF II	40
	VW	JETTA I	40
	VW	JETTA II	40
	VW	PASSAT (32, 32B)	40
	VW	SCIROCCO (53B)	40
VW	CADDY I	40	
<b>8229</b>	AUDI	80 (- 08/86)	36
	SEAT	TOLEDO I	36
	VW	GOLF I	36
	VW	GOLF I	36
	VW	GOLF II	36
	VW	JETTA I	36
	VW	JETTA II	36
	VW	PASSAT (3A2, 35I)	36
	VW	SCIROCCO (53)	36
	VW	SCIROCCO (53B)	36
	VW	TRANSPORTER T3	36
VW	TRANSPORTER T4	36	
VW	TRANSPORTER T4	36	
<b>8230</b>	AUDI	80 (- 08/86)	36
	AUDI	80 (09/86-08/91)	36
	AUDI	90 (- 03/87)	36
	AUDI	90 (04/87-07/91)	36
	BMW - MINI	Serie 3 (E21)	36
	BMW - MINI	Serie 3 (E30)	36
	BMW - MINI	Serie 5 (E28)	36
	BMW - MINI	Serie 5 (E34)	36
	BMW - MINI	Serie 6 (E24)	36
	BMW - MINI	Serie 7 (E23)	36
	BMW - MINI	Serie 7 (E32)	36
<b>8232</b>	AUDI	100 (68-76)	40
	AUDI	100 (68-76)	40
	AUDI	100 (76-82)	40
	AUDI	100 (76-82)	40
	MERCEDES	200 (W123)	40
	MERCEDES	200 (W123)	40
	MERCEDES	200 (W123)	40
	MERCEDES	200 (W123)	40
	MERCEDES	200 (W123)	40
	MERCEDES	200 (W123)	40
	MERCEDES	200 (W123)	40
	MERCEDES	200 (W123)	40
	MERCEDES	CLASSE G (W461)	40
	MERCEDES	CLASSE G (W463)	40



# LISTA NUMERICA

Catalogo  
0113



	 Costruttore Car Manufacturers		N° Figura Drawing N°
8232	VW	LT I	40
	VW	LT I	40
	VW	LT I	40
8233	VOLVO	440-460	40
8234	ALFA ROMEO	33 (4x4)	40
	VW	GOLF I	40
	VW	SCIROCCO (53)	40
8237	VW	1200 - 1300	105
8238	VW	1200 - 1300	104
8239	VW	1200 - 1300	105
8240	PORSCHE	914	104
	VW	1200 - 1300	104
	VW	TRANSPORTER T2	104
8241	PORSCHE	914	104
	VW	TRANSPORTER T2	104
8242	VOLVO	340-360	36
8243	MERCEDES	200 (W114-115)	36
	MERCEDES	CLASSE S (W116)	36
	MERCEDES	CLASSE S (W126)	36
	MERCEDES	CLASSE SL (R107)	36
	VOLVO	240-260	36
8244	VOLVO	740, 760	40
8245	PEUGEOT	404	516
	PEUGEOT	404	516
	PEUGEOT	504	516
	PEUGEOT	504	516
8247	VW	GOLF I	38
8248	VW	GOLF I	41
	VW	SCIROCCO (53)	41
8249	VW	GOLF I	41
	VW	JETTA I	41
	VW	PASSAT (32, 32B)	41
	VW	SCIROCCO (53B)	41
8254	MERCEDES	200 (W114-115)	36
	VW	PASSAT (32, 32B)	36
8256	VW	LT I	36
	VW	LT I	36
	VW	TRANSPORTER T3	36
8264	FIAT	PUNTO II	158
8265	FIAT	IDEA	156
	FIAT	PUNTO II	156
	LANCIA	MUSA	156
	LANCIA	YPSILON (MOD. 2003)	156
8266	FIAT	127 (900, 1050)	125
	FIAT	128	125
	FIAT	131	125
	FIAT	RITMO	125
	FIAT COMM	FIORINO	125
	LANCIA	A112	125



	 Costruttore Car Manufacturers		N° Figura Drawing N°	
8266	SEAT	FURA	125	
	ZASTAVA	101	125	
	ZASTAVA	YUGO	125	
8268	FIAT COMM	241	122	
8269	FIAT	127 (900, 1050)	125	
	FIAT	127 (1050, 1300 Sport)	125	
	FIAT	128	125	
	FIAT COMM	FIORINO	125	
	FIAT COMM	FIORINO	125	
	LANCIA	A112	125	
	SEAT	FURA	125	
	ZASTAVA	101	125	
8270	FIAT VI	615N,N1 - 616N,N1,N2,N2/4,N3, N3/N4 - 625N,N1,N2,N3	513	
	8271	LANCIA	FULVIA	134
	8272	LANCIA	FULVIA	134
8273	LANCIA	FULVIA	122	
8276	IVECO/OM	120	475	
8277	IVECO/OM	Cerbiatto - Daino - Leoncino (CO3)	487	
	IVECO/OM	Tigrotto (CO3)	487	
8278	IVECO/OM	Cerbiatto - Daino - Leoncino (CO3)	487	
	IVECO/OM	Tigrotto (CO3)	487	
8280	TALBOT	SIMCA 1000	128	
	TALBOT	SIMCA 1000	128	
8281	FIAT	125	125	
	FIAT	132	125	
	POLSKI	125-P	125	
8282	FIAT	131	122	
	FIAT	132	122	
8283	ALFA ROMEO	ALFETTA	492	
	ALFA ROMEO	GIULIETTA	492	
	ALFA ROMEO	GTV -01/81	492	
8284	ALFA ROMEO	ALFETTA	494	
	ALFA ROMEO	GIULIETTA	494	
	ALFA ROMEO	GTV -01/81	494	
8285	IVECO	50 NC - 55 NC	496	
	IVECO/OM	OM 50 - 55	496	
8286	IVECO	50 NC - 55 NC	490	
	IVECO	50.8, 50 F8, 50.9, 50 F9, 50.10, 55.8, 55 F8, 55.9,55 F9 55.10,55 F10, 60.8, 60.10, 65.10, 65 F10, 70.10,70.10/1, 70.12, 75.10, 75 F10, 79.10, 79 F10	490	
	IVECO	79.14 - 79.14 Zeta - 95.14 - 95.14 Zeta - 109.14 - 109.14 Zeta	490	
	IVECO/OM	OM 50 - 55	490	
	IVECO/OM	OM 65 - 70	490	
	8288	FIAT VI	130 NC	489
	FIAT VI	130 NC	489	



	Costruttore Car Manufacturers		N° Figura Drawing N°
8288	IVECO	100 NC - 110 NC	489
	IVECO	100 NC - 110 NC	489
	IVECO	120 F13 - 120 F14	489
	IVECO	120 F13 - 120 F14	489
	IVECO	150 F14 - 150.17	489
	IVECO/OM	OM 100 - 110 - 130	489
	IVECO/OM	OM 100 - 110 - 130	489
8289	ALFA ROMEO	ALFASUD	40
	MERCEDES	190	40
	MERCEDES	200 (W123)	40
	MERCEDES	200 (W124)	40
	MERCEDES	CLASSE C (W202)	40
	MERCEDES	CLASSE E (W124)	40
	MERCEDES	CLASSE S (W116)	40
	MERCEDES	CLASSE S (W126)	40
	MERCEDES	CLASSE S (W140)	40
	MERCEDES	CLASSE SL (R107)	40
8290	ALFA ROMEO	ALFASUD	40
8292	IVECO	80NC, 90NC	520
8293	IVECO	80NC, 90NC	521
	IVECO/OM	OM 80 - 90	521
8294	IVECO	80NC, 90NC	520
	IVECO/OM	OM 80 - 90	520
8296	IVECO	40 NC - 40/35 NC	517
8298	IVECO/OM	OM 80 - 90	520
8299	IVECO/OM	OM 80 - 90	521
8300	IVECO/OM	OM 65 - 70	497
8302	IVECO/OM	OM 65 - 70	498
8303	LANCIA	BETA	126
8304	LANCIA	BETA	126
8305	LANCIA	BETA	126
8306	IVECO	79.13 - 80.13 - 90.13 - 90 F13 - 100.13 - 100 F13	489
	IVECO/OM	100 N	489
8307	IVECO	79.13 - 80.13 - 90.13 - 90 F13 - 100.13 - 100 F13	489
	IVECO/OM	100 N	489
8308	TALBOT	SIMCA 1000	127
8309	RENAULT	R4	90
	RENAULT	R5	90
	RENAULT comm	R4 FURG	90
8312	FIAT COMM	242	522
8314	FIAT	PANDA (30, 45 (->10/85))	125
	FIAT	RITMO	125
8315	FIAT	PANDA (30, 45 (->10/85))	122
8316	FIAT COMM	238	125
8317	CITROEN	AX	454
8320	FIAT	PANDA (30, 45 (->10/85))	125
	LANCIA	A112	125



	Costruttore Car Manufacturers		N° Figura Drawing N°
8321	LANCIA	DELTA	126
8322	LANCIA	DELTA	125
8323	RENAULT	R12	135
	RENAULT	R15	135
	RENAULT	R16	135
	RENAULT	R17	135
8324	RENAULT	R12	136
	RENAULT	R15	136
	RENAULT	R17	136
8325	PEUGEOT	204	88
	PEUGEOT	304	88
8326	PEUGEOT	204	523
	PEUGEOT	304	523
8327	LADA	1200, 1300, 1500, 1600	125
	LADA	NOVA	125
	LANCIA	A112	125
8328	CITROEN COMM	C15	156
8330	TALBOT	1307, 1308, 1309	45
	TALBOT	HORIZON	45
	TALBOT	SOLARA	45
	TALBOT	TAGORA	45
8332	RENAULT	R14	161
	RENAULT	R18	161
	RENAULT	R18	161
8333	RENAULT	ESPACE I	156
	RENAULT	R14	156
	SKODA	FAVORIT	156
8334	IVECO	50 NC - 55 NC	499
	IVECO	50.8, 50 F8, 50.9, 50 F9, 50.10, 55.8, 55 F8, 55.9,55 F9 55.10,55 F10, 60.8 60.10, 65.10, 65 F10, 70.10,70.10/1, 70.12, 75.10, 75 F10, 79.10, 79 F10	499
8335	IVECO/OM	OM 50 - 55	499
	IVECO	50 NC - 55 NC	518
	IVECO/OM	OM 50 - 55	518
8336	IVECO/OM	OM 65 - 70	518
	IVECO	50.8, 50 F8, 50.9, 50 F9, 50.10, 55.8, 55 F8, 55.9,55 F9 55.10,55 F10, 60.8 60.10, 65.10, 65 F10, 70.10,70.10/1, 70.12, 75.10, 75 F10, 79.10, 79 F10	519
	IVECO	50.8, 50 F8, 50.9, 50 F9, 50.10, 55.8, 55 F8, 55.9,55 F9 55.10,55 F10, 60.8 60.10, 65.10, 65 F10, 70.10,70.10/1, 70.12, 75.10, 75 F10, 79.10, 79 F10	519
8339	IVECO	DAILY	494
8340	IVECO	DAILY	494
8341	IVECO	DAILY	494
8342	IVECO	DAILY	494
8344	IVECO	79.13 - 80.13 - 90.13 - 90 F13 - 100.13 - 100 F13	500
8348	IVECO/OM	OM 65 - 70	499
8350	FIAT	UNO	158
8351	CITROEN	AX	156







	Costruttore Car Manufacturers		N° Figura Drawing N°
8351	FIAT	UNO	156
	FIAT	UNO	156
	FIAT COMM	FIORINO (88->93)	156
8352	FIAT	RITMO	158
	FIAT	UNO	158
	FIAT	UNO	158
	FIAT COMM	FIORINO (88->93)	158
8353	FIAT	PANDA (30, 45 (->10/85))	158
	SEAT	MARBELLA	158
	SEAT	TERRA	158
8354	CITROEN COMM	C25	158
	FIAT	131	158
	FIAT	ARGENTA	158
	FIAT	PANDA (30, 45 (->10/85))	158
	FIAT COMM	DUCATO	158
	PEUGEOT	J5	158
	SEAT	MARBELLA	158
	TALBOT	EXPRESS	158
8355	FIAT	131	158
	FIAT	REGATA	158
	FIAT	RITMO II	158
	LANCIA	DELTA	158
	SEAT	IBIZA I (021A)	158
	SEAT	MALAGA	158
8356	FIAT	REGATA	162
	FIAT	RITMO II	162
	FIAT	RITMO FL85	162
8357	FIAT	ARGENTA	158
	LANCIA	Y10	158
8358	FIAT	ARGENTA	158
8359	FIAT	127 (900, 1050)	123
	FIAT	127 (Diesel, Panorama, Rustica, 147)	123
8360	FIAT	127 (900, 1050)	120
	FIAT	127 (900, 1050)	120
	FIAT	127 (Diesel, Panorama, Rustica, 147)	120
	FIAT	127 (Diesel, Panorama, Rustica, 147)	120
8361	FIAT	127 (Diesel, Panorama, Rustica, 147)	121
8362	FIAT	127 (900, 1050)	125
	FIAT COMM	FIORINO	125
8363	FIAT	131	158
8364	FIAT COMM	DUCATO	158
	TALBOT	EXPRESS	158
8365	CITROEN COMM	C25	158
	FIAT COMM	DUCATO	158
	PEUGEOT	J5	158
	TALBOT	EXPRESS	158



	Costruttore Car Manufacturers		N° Figura Drawing N°
8366	IVECO	50.8, 50 F8, 50.9, 50 F9, 50.10, 55.8, 55 F8, 55.9,55 F9 55.10,55 F10, 60.8 60.10, 65.10, 65 F10, 70.10,70.10/1, 70.12, 75.10, 75 F10, 79.10, 79 F10	499
8367	FIAT	RITMO	125
	FIAT COMM	238	125
8370	ALFA ROMEO	33 (-1989)	40
	ALFA ROMEO	ARNA	40
8371	LANCIA	DELTA	158
	LANCIA	PRISMA	158
8372	LANCIA	DELTA	163
	LANCIA	DELTA	163
	LANCIA	PRISMA	163
	LANCIA	PRISMA	163
8373	LANCIA	DELTA	162
	LANCIA	PRISMA	162
	LANCIA	PRISMA	162
	LANCIA	PRISMA	162
8375	LANCIA	DELTA	158
	LANCIA	DELTA	158
	LANCIA	PRISMA	158
8376	ALFA ROMEO	75	492
	ALFA ROMEO	90	492
	ALFA ROMEO	ALFETTA	492
	ALFA ROMEO	GIULIETTA	492
	ALFA ROMEO	GTV (02/81-)	492
	ALFA ROMEO	GTV (02/81-)	492
8377	ALFA ROMEO	75	494
	ALFA ROMEO	90	494
	ALFA ROMEO	ALFETTA	494
	ALFA ROMEO	GIULIETTA	494
	ALFA ROMEO	GTV (02/81-)	494
	ALFA ROMEO	GTV (02/81-)	494
8379	INNOCENTI	SMALL	460
8380	INNOCENTI	SMALL	461
8381	FIAT	UNO	158
	LANCIA	Y10	158
8382	FIAT	PANDA (750, 903, 1000 (11/85->))	158
	FIAT	PANDA (1.3 Diesel)	158
	FIAT	TEMPRA	158
	LANCIA	DEDRA	158
	LANCIA	DEDRA	158
	LANCIA	Y10	158
	LANCIA	Y10	158
	LANCIA	Y10	158
8383	CITROEN	LN - LNA	158
	CITROEN	VISA	158
	CITROEN COMM	C15	158
	PEUGEOT	104	158
	PEUGEOT	204	158
	PEUGEOT	304	158
	PEUGEOT	504	158
PEUGEOT	505	158	



	Costruttore Car Manufacturers		N° Figura Drawing N°
8383	PEUGEOT	504 PIKUP	158
	TALBOT	SAMBA	158
8384	CITROEN	LN - LNA	156
	CITROEN	VISA	156
	PEUGEOT	104	156
	TALBOT	SAMBA	156
8385	CITROEN	LN - LNA	158
	PEUGEOT	104	158
	TALBOT	SAMBA	158
8386	CITROEN	AX	158
	CITROEN	AX	158
	CITROEN	LN - LNA	158
	CITROEN	VISA	158
	CITROEN	VISA	158
8387	CITROEN	LN - LNA	158
	CITROEN	VISA	158
8389	RENAULT	R18	158
8390	RENAULT	ESPACE I	158
	RENAULT	FUEGO	158
	RENAULT	R18	158
	RENAULT	R18	158
	RENAULT	R18	158
	RENAULT	R20	158
8391	RENAULT	ESPACE I	156
	RENAULT	FUEGO	156
	RENAULT	R18	156
	RENAULT	R18	156
8392	RENAULT	ESPACE I	158
	RENAULT	ESPACE II	158
	RENAULT	FUEGO	158
	RENAULT	R18	158
	RENAULT	R18	158
	RENAULT	R18	158
	RENAULT	R18	158
	RENAULT	R18	158
	RENAULT	R18	158
8394	PEUGEOT	305	158
8395	PEUGEOT	305	156
8396	ROVER	METRO	482
8397	FORD	TRANSIT -86	5
8398	FORD	TRANSIT -86	6
8400	FIAT	CROMA	158
	LANCIA	THEMA	158
8401	FIAT	CROMA	158
	LANCIA	KAPPA	158
	LANCIA	THEMA	158
	LANCIA	THEMA	158
8402	FORD	TRANSIT -86	7
8403	FIAT	TEMPRA	158
	FIAT	TIPO	158

	Costruttore Car Manufacturers		N° Figura Drawing N°
8403	LANCIA	DEDRA	158
	LANCIA	DEDRA	158
	LANCIA	DELTA	158
	LANCIA	DELTA	158
8404	FIAT	TIPO	156
	FIAT	TIPO	156
	RENAULT	R20	156
8405	FIAT	DUNA	158
	FIAT	RITMO FL85	158
	FIAT	UNO	158
	INNOCENTI	ELBA	158
8406	FIAT	DUNA	156
	FIAT	UNO	156
	INNOCENTI	ELBA	156
	PEUGEOT	204	156
	PEUGEOT	304	156
	PEUGEOT	205 VAN	156
8407	FIAT	UNO	158
8408	FIAT COMM	DUCATO	158
8410	CITROEN COMM	C25	158
	FIAT COMM	DUCATO	158
	FIAT COMM	TALENTO	158
	PEUGEOT	J5	158
	TALBOT	EXPRESS	158
	8411	CITROEN COMM	C25
8411	FIAT COMM	DUCATO	158
	FIAT COMM	TALENTO	158
	PEUGEOT	J5	158
	TALBOT	EXPRESS	158
8413	FIAT	PANDA Selecta	158
8414	FIAT	REGATA	162
8415	FIAT	TEMPRA	158
	FIAT	TEMPRA	158
	FIAT	TEMPRA	158
	FIAT	TEMPRA	158
	FIAT	TEMPRA	158
	FIAT	TIPO	158
	FIAT	TIPO	158
	FIAT	TIPO	158
	FIAT	TIPO	158
	LANCIA	DEDRA	158
	LANCIA	DEDRA	158
	LANCIA	DEDRA	158
	LANCIA	DEDRA	158
	LANCIA	DEDRA	158
	LANCIA	DEDRA	158
LANCIA	DELTA	158	
LANCIA	DELTA	158	
LANCIA	DELTA	158	

	Costruttore Car Manufacturers		N° Figura Drawing N°
<b>8416</b>	FIAT	REGATA	158
<b>8417</b>	ALFA ROMEO	145 (09/94-12/96)	156
	ALFA ROMEO	145 (01/97-01/01)	156
	ALFA ROMEO	146 (12/94-12/96)	156
	ALFA ROMEO	146 (01/97-01/01)	156
	FIAT	BRAVA/O	156
	FIAT	BRAVA/O	156
	FIAT	BRAVA/O	156
	FIAT	COUPE'	156
	FIAT	MAREA	156
	FIAT	MULTIPLA	156
	FIAT	TEMPRA	156
	FIAT	TEMPRA	156
	FIAT	TEMPRA	156
	FIAT	TIPO	156
	FIAT	TIPO	156
	FIAT	TIPO	156
	FIAT	TIPO	156
	LANCIA	DEDRA	156
	LANCIA	DEDRA	156
	LANCIA	DEDRA	156
	LANCIA	DEDRA	156
	LANCIA	DEDRA	156
	LANCIA	DEDRA	156
	LANCIA	DEDRA	156
	LANCIA	DEDRA	156
	LANCIA	DEDRA	156
	LANCIA	DELTA	156
	LANCIA	DELTA	156
	LANCIA	DELTA	156
	LANCIA	DELTA	156
	LANCIA	DELTA	156
	<b>8419</b>	ALFA ROMEO	33 (1990-12/93)
<b>8420</b>	ALFA ROMEO	33 (-1989)	482
	ALFA ROMEO	33 (4x4)	482
<b>8421</b>	ALFA ROMEO	33 (-1989)	482
	ALFA ROMEO	33 (1990-12/93)	482
	ALFA ROMEO	ARNA	482
<b>8422</b>	ALFA ROMEO	33 (1990-12/93)	455
<b>8423</b>	ALFA ROMEO	33 (1990-12/93)	36
<b>8424</b>	FIAT	PANDA (750, 903, 1000 (11/85->))	158
	FIAT	PANDA Selecta	158
	FIAT	PANDA 4x4	158
<b>8425</b>	CITROEN COMM	JUMPER	158
	FIAT	PANDA 4x4	158
	FIAT COMM	DUCATO (Mod. 94)	158
	FIAT COMM	TALENTO	158



	Costruttore Car Manufacturers		N° Figura Drawing N°
<b>8425</b>	PEUGEOT	BOXER	158
<b>8426</b>	FIAT	PANDA (750, 903, 1000 (11/85->))	158
	FIAT	PANDA (1.3 Diesel)	158
<b>8427</b>	FIAT	BARCETTA	156
	FIAT	MULTIPLA	156
	FIAT	PUNTO	156
	FIAT	PUNTO	156
	FIAT	PUNTO	156
	FIAT	PUNTO	156
	FIAT	PUNTO	156
	FIAT	PUNTO	156
	FIAT	PUNTO	156
	FIAT	PUNTO	156
	FIAT	UNO	156
	FIAT	UNO	156
	FIAT	UNO	156
	FIAT	UNO	156
LANCIA	Y	156	
LANCIA	Y	156	
<b>8428</b>	FIAT	UNO	158
	FIAT	UNO	158
<b>8429</b>	FIAT	ARGENTA	158
	FIAT	UNO	158
<b>8430</b>	LANCIA	Y10	158
<b>8431</b>	LANCIA	Y10	158
<b>8432</b>	LANCIA	PRISMA	158
<b>8433</b>	FIAT	TEMPRA	158
	FIAT	TIPO	158
	FIAT	TIPO	158
<b>8434</b>	ALFA ROMEO	164	156
<b>8435</b>	ALFA ROMEO	164	158
<b>8436</b>	ALFA ROMEO	145 (09/94-12/96)	158
	ALFA ROMEO	145 (01/97-01/01)	158
	ALFA ROMEO	146 (12/94-12/96)	158
	ALFA ROMEO	146 (01/97-01/01)	158
	ALFA ROMEO	155	158
	ALFA ROMEO	GTV (Mod 95)	158
	ALFA ROMEO	SPIDER (Mod.95)	158
	FIAT	COUPE'	158
<b>8443</b>	LANCIA	DEDRA	158
	LANCIA	DELTA	158
	LANCIA	DELTA	158
	DACIA	LOGAN	454
	DACIA	SANDERO	454
	RENAULT	R5 Super	454
<b>8444</b>	RENAULT	SAFRANE I	454
	RENAULT comm	EXPRESS	454
	DACIA	DUSTER	453
	DACIA	LOGAN	453
<b>8443</b>	DACIA	SANDERO	453
	RENAULT	LAGUNA I	453



	Costruttore Car Manufacturers		N° Figura Drawing N°
8444	RENAULT	R5 Super	453
	RENAULT	R21	453
	RENAULT	R21	453
	RENAULT comm	EXPRESS	453
8445	RENAULT	CLIO I	454
8446	RENAULT	CLIO I	453
	RENAULT	R9 - R11	453
	RENAULT	R9 - R11	453
	RENAULT	R9 - R11	453
	RENAULT	R9 - R11	453
8447	FIAT	CINQUECENTO	158
8448	FIAT	CINQUECENTO	156
	FIAT	SEICENTO	156
8449	IVECO	DAILY	524
	IVECO	NEW DAILY	524
	IVECO	DAILY Heavy Duty	524
8450	IVECO	DAILY	525
	IVECO	DAILY Heavy Duty	525
8451	IVECO	DAILY	525
8453	LANDROVER	RANGE ROVER	478
8454	LANDROVER	DISCOVERY	492
	LANDROVER	RANGE ROVER	492
8455	LANDROVER	RANGE ROVER	479
8456	LANDROVER	DISCOVERY	482
	LANDROVER	RANGE ROVER	482
8457	BMW - MINI	Serie 3 (E21)	40
	BMW - MINI	Serie 3 (E30)	40
	BMW - MINI	Serie 5 (E60)	40
	BMW - MINI	Serie 6 (E63,E64)	40
	BMW - MINI	Serie 7 (E65,E66)	40
	VOLVO	240-260	40
	VOLVO	740, 760	40
	VOLVO	940, 960	40
8458	BMW - MINI	Serie 5 (E28)	40
	BMW - MINI	Serie 5 (E34)	40
	BMW - MINI	Serie 6 (E24)	40
	BMW - MINI	Serie 7 (E32)	40
	BMW - MINI	Serie 8 (E31)	40
8459	ALFA ROMEO	145 (09/94-12/96)	158
	ALFA ROMEO	145 (01/97-01/01)	158
	ALFA ROMEO	146 (12/94-12/96)	158
	ALFA ROMEO	146 (01/97-01/01)	158
	ALFA ROMEO	155	158
	ALFA ROMEO	155	158
	CITROEN COMM	JUMPER (Mod. 2002)	158
	FIAT	BARCETTA	158
	FIAT	BRAVAO	158
	FIAT	COUPE'	158
	FIAT	MAREA	158

	Costruttore Car Manufacturers		N° Figura Drawing N°
8459	FIAT	PUNTO	158
	FIAT	TEMPRA	158
	FIAT	TEMPRA	158
	FIAT	TIPO	158
	FIAT	TIPO	158
	FIAT	TIPO	158
	FIAT COMM	DUCATO (Mod. 2002)	158
	LANCIA	DEDRA	158
	LANCIA	DEDRA	158
	LANCIA	DEDRA	158
	LANCIA	DEDRA	158
	LANCIA	DEDRA	158
	LANCIA	DEDRA	158
	LANCIA	DEDRA	158
	LANCIA	DEDRA	158
	LANCIA	DEDRA	158
	LANCIA	DELTA	158
	LANCIA	DELTA	158
	LANCIA	DELTA	158
	LANCIA	DELTA	158
	LANCIA	DELTA	158
	LANCIA	DELTA	158
	LANCIA	DELTA	158
	PEUGEOT	BOXER (Mod. 2002)	158
	8460	FORD	FIESTA 77-89
8461	FORD	CORTINA	482
	FORD	ESCORT 86-90	482
	FORD	ORION (83-90)	482
8462	FORD	ESCORT 80-86	501
	FORD	ESCORT 86-90	501
	FORD	ORION (83-90)	501
8463	FORD	ESCORT 80-86	501
	FORD	ESCORT 86-90	501
	FORD	ORION (83-90)	501
8464	FORD	TRANSIT -91	8
	FORD	TRANSIT 91-	8
8465	FORD	TRANSIT -91	9
	FORD	TRANSIT 91-	9
8466	FORD	TRANSIT -91	5
	FORD	TRANSIT -91	5
8467	FORD	TRANSIT -91	6
	FORD	TRANSIT -91	6
8468	FORD	TRANSIT -91	3
8469	FORD	TRANSIT -91	4
8470	LANCIA	THEMA	158
8472	ROVER	METRO	492
	ROVER	SERIE 100	492
8473	ROVER	METRO	482



# LISTA NUMERICA



Catalogo  
0113



	Costruttore Car Manufacturers		N° Figura Drawing N°
8474	ROVER	MAESTRO	482
	ROVER	MONTEGO	482
8475	ROVER	MONTEGO	104
8476	ROVER	SERIE 200	168
8477	ROVER	SERIE 200	165
	ROVER	SERIE 200	165
	ROVER	SERIE 400	165
8478	HONDA	CONCERTO	184
	ROVER	SERIE 200	184
	ROVER	SERIE 400	184
8480	ROVER	SERIE 200	40
	ROVER	SERIE 400	40
8481	FIAT	PUNTO	158
	LANCIA	Y	158
8482	FIAT	PUNTO	158
	FIAT	PUNTO	158
	LANCIA	Y	158
8483	FIAT	PUNTO	158
	FIAT	PUNTO	158
	FIAT	PUNTO	158
	FIAT	PUNTO	158
	FIAT	PUNTO	158
	FIAT	PUNTO	158
	LANCIA	Y	158
8484	FIAT	PUNTO	158
	FIAT	PUNTO	158
	FIAT	PUNTO	158
	FIAT	PUNTO	158
	FIAT	PUNTO	158
	LANCIA	Y	158
8485	CITROEN	BERLINGO	454
	CITROEN	XSARA	454
	CITROEN	PICASSO	454
	PEUGEOT	1007	454
	PEUGEOT	RANCH / PARTNER	454
8486	FIAT	BRAVAO	156
	FIAT	BRAVAO	156
	FIAT	TEMPRA	156
	FIAT	TIPO	156
	FIAT	TIPO	156
	LANCIA	DEDRA	156
	LANCIA	DEDRA	156
	LANCIA	DEDRA	156
	LANCIA	DEDRA	156
	LANCIA	DELTA	156
	LANCIA	DELTA	156
	LANCIA	DELTA	156
	LANCIA	DELTA	156
	LANCIA	DELTA	156
	LANCIA	DELTA	156



	Costruttore Car Manufacturers		N° Figura Drawing N°
8486	LANCIA	DELTA	156
	LANCIA	DELTA	156
8487	MERCEDES	190	45
	MERCEDES	200 (W123)	45
	MERCEDES	200 (W123)	45
	MERCEDES	200 (W123)	45
	MERCEDES	200 (W123)	45
	MERCEDES	200 (W123)	45
	MERCEDES	200 (W123)	45
	MERCEDES	200 (W123)	45
	MERCEDES	200 (W124)	45
	MERCEDES	CLASSE E (W124)	45
	MERCEDES	CLASSE S (W126)	45
	MERCEDES	CLASSE SL (R107)	45
	MERCEDES	CLASSE SL (R129)	45
8489	ALFA ROMEO	155	158
	ALFA ROMEO	155	158
	FIAT	PANDA (750, 903, 1000 (11/85->))	158
	FIAT	PANDA Selecta	158
	LANCIA	DEDRA	158
	LANCIA	Y10	158
8492	ALFA ROMEO	164	158
8493	ALFA ROMEO	164	156
8494	RENAULT	ESPACE III	454
	RENAULT	R19	454
	RENAULT	R21	454
	RENAULT	R21	454
8495	RENAULT	MEGANE	453
	RENAULT	SCENIC	453
	RENAULT	R19	453
8496	RENAULT	CLIO I	454
	RENAULT	R21	454
	RENAULT	R21	454
8497	RENAULT	R21	454
	RENAULT	R21	454
	RENAULT	R21	454
	RENAULT	R21	454
	RENAULT	TWINGO	454
	RENAULT comm	TRAFIC	454
8498	RENAULT comm	TRAFIC	454
8499	RENAULT comm	TRAFIC	454
8500	RENAULT	R9 - R11	454
8501	PEUGEOT	206	453
	RENAULT	R5 Super	453
	RENAULT	R5 Super	453
	RENAULT	R9 - R11	453
	RENAULT	R9 - R11	453
	RENAULT	R9 - R11	453
	RENAULT	R9 - R11	453
	RENAULT	R9 - R11	453
	RENAULT	R9 - R11	453
	RENAULT	R19	453



	Costruttore Car Manufacturers		N° Figura Drawing N°
8501	RENAULT	R25	453
	RENAULT	TWINGO	453
	RENAULT comm	EXPRESS	453
8502	VOLVO	340-360	40
8503	PEUGEOT	404	515
8504	PEUGEOT	504	158
	PEUGEOT	505	158
8505	PEUGEOT	504	515
8506	PEUGEOT	504	156
	PEUGEOT	505	156
8509	LADA	SAMARA	48
8510	SEAT	IBIZA I (021A)	162
	SEAT	MALAGA	162
	SEAT	RONDA	162
8511	LADA	SAMARA	47
8512	SEAT	IBIZA I (021A)	158
	SEAT	MALAGA	158
	SEAT	RONDA	158
8513	SEAT	IBIZA I (021A)	162
	SEAT	MALAGA	162
8514	SUZUKI	SJ 410, SJ 413, SANTANA	495
8515	CITROEN	SAXO	454
	PEUGEOT	106	454
	PEUGEOT	106	454
	PEUGEOT	106	454
8516	CITROEN	SAXO	453
	PEUGEOT	106	453
	PEUGEOT	106	453
	PEUGEOT	206	453
8517	CITROEN COMM	JUMPER	158
	FIAT COMM	DUCATO (Mod. 94)	158
	PEUGEOT	BOXER	158
8518	CITROEN	SAXO	453
	PEUGEOT	106	453
	PEUGEOT	106	453
	PEUGEOT	106	453
8519	CITROEN	XSARA	454
8522	SUBARU	LEONE	197
8523	SUBARU	LEONE	196
8524	SUZUKI	SJ 410, SJ 413, SANTANA	482
8525	SUZUKI	SJ 410, SJ 413, SANTANA	482
8526	LADA	NIVA	125
8527	LADA	NIVA	125
8528	CITROEN	VISA	158
	CITROEN COMM	C15	158
	PEUGEOT	205	158
	PEUGEOT	205	158
	PEUGEOT	205 VAN	158
8529	CITROEN	VISA	158

	Costruttore Car Manufacturers		N° Figura Drawing N°
8529	PEUGEOT	309	158
	PEUGEOT	505	158
8530	PEUGEOT	205	156
	PEUGEOT	205	156
	PEUGEOT	309	156
	PEUGEOT	309	156
	PEUGEOT	309	156
	PEUGEOT	205 VAN	156
8531	CITROEN COMM	JUMPER	158
	FIAT COMM	DUCATO (Mod. 94)	158
	PEUGEOT	309	158
	PEUGEOT	BOXER	158
8532	PEUGEOT	205	158
	PEUGEOT	309	158
8533	PEUGEOT	405	466
8534	PEUGEOT	205	466
	PEUGEOT	405	466
8535	PEUGEOT	405	453
	PEUGEOT	605	453
8536	PEUGEOT	405	454
8537	TOYOTA	CAMRY (V1-V2)	132
8538	TOYOTA	CAMRY (V1-V2)	192
8539	TOYOTA	CAMRY (V1-V2)	192
	TOYOTA	COROLLA (E9)	192
8540	OPEL	CORSA A	111
8541	CHEVROLET / DAEWOO	ESPERO	109
	CHEVROLET / DAEWOO	LANOS	109
	CHEVROLET / DAEWOO	NEXIA	109
	OPEL	ASCONA C	109
	OPEL	ASTRA F	109
	OPEL	CALIBRA	109
	OPEL	CORSA A	109
	OPEL	CORSA B	109
	OPEL	KADETT E	109
	OPEL	OMEGA B	109
	OPEL	TIGRA	109
	OPEL	VECTRA A	109
	OPEL	VECTRA B	109
	SAAB	9-5	109
8542	OPEL	CORSA A	164
8543	OPEL	ASCONA C	164
	OPEL	KADETT D	164
	OPEL	KADETT E	164
8544	OPEL	KADETT E	440
8545	OPEL	ASCONA B	111
	OPEL	ASCONA C	111
	OPEL	ASTRA F	111
	OPEL	CALIBRA	111

	 Costruttore Car Manufacturers		N° Figura Drawing N°
8545	OPEL	KADETT E	111
	OPEL	VECTRA A	111
	OPEL COMM	KADETT E - KOMBI	111
	SAAB	900	111
	SAAB	900	111
	SAAB	9-3 (YS3D)	111
	SAAB	9-3 (YS3F)	111
8547	CITROEN	ZX	454
8548	CITROEN	AX	156
	CITROEN	XSARA	156
	CITROEN	XSARA	156
	CITROEN	ZX	156
	PEUGEOT	306	156
8549	OPEL	KADETT E	442
	OPEL COMM	KADETT E - KOMBI	442
8550	VW	CORRADO	50
	VW	PASSAT (3A2, 35I)	50
8551	SEAT	CORDOBA (6K2/C2)	43
	SEAT	CORDOBA (6K2/6K5)	43
	SEAT	IBIZA II-III (6K1)	43
	SEAT	INCA	43
	VW	CORRADO	43
	VW	GOLF III	43
	VW	POLO CLASSIC (6KV2), POLO VARIANT (6KV5)	43
	VW	VENTO	43
	VW	CADDY II	43
8552	ALFA ROMEO	145 (01/97-01/01)	158
	ALFA ROMEO	145 (01/97-01/01)	158
	ALFA ROMEO	146 (01/97-01/01)	158
	ALFA ROMEO	146 (01/97-01/01)	158
	FIAT	BRAVA/O	158
	FIAT	BRAVA/O	158
	LANCIA	DEDRA	158
	LANCIA	DEDRA	158
	LANCIA	DELTA	158
	LANCIA	DELTA	158
8553	ALFA ROMEO	145 (01/97-01/01)	158
	ALFA ROMEO	145 (01/97-01/01)	158
	ALFA ROMEO	146 (01/97-01/01)	158
	ALFA ROMEO	146 (01/97-01/01)	158
	FIAT	BRAVA/O	158
	LANCIA	DEDRA	158
	LANCIA	DELTA	158
	LANCIA	DELTA	158
	LANCIA	DELTA	158
	LANCIA	DELTA	158
8554	FIAT	BRAVA/O	158
	FIAT	MAREA	158
	LANCIA	LYBRA	158
8555	FORD	ESCORT (90 - 95) Berl	504



	 Costruttore Car Manufacturers		N° Figura Drawing N°
8556	FORD	ESCORT (90 - 95) Berl	503
	FORD	ESCORT (90 - 95) Berl	503
8557	FORD	ESCORT (90 - 95) Berl	504
8558	FORD	ESCORT (90 - 95) Berl	503
	FORD	ESCORT (90 - 95) Berl	503
8559	FIAT	PUNTO	158
	FIAT	PUNTO	158
8560	FIAT	BARCETTA	158
	FIAT	PUNTO	158
8561	CITROEN	BERLINGO	464
	CITROEN	PICASSO	464
	PEUGEOT	RANCH / PARTNER	464
8562	FIAT	MULTIPLA	158
8563	FIAT	SEICENTO	158
8564	FIAT	CINQUECENTO	158
	FIAT	SEICENTO	158
8565	FORD	FIESTA 89-95	505
	FORD	GRANADA	505
	FORD	SIERRA	505
8566	ALFA ROMEO	33 (1990-12/93)	454
8567	ALFA ROMEO	147	158
	ALFA ROMEO	156	158
8568	ALFA ROMEO	147	158
	ALFA ROMEO	156	158
8569	CITROEN	EVASION	456
	CITROEN COMM	JUMPY	456
	FIAT	ULYSSE	456
	FIAT COMM	SCUDO	456
	LANCIA	ZETA	456
	PEUGEOT	806	456
8570	PEUGEOT	EXPERT	456
	CITROEN	EVASION	454
	CITROEN	SAXO	454
	CITROEN COMM	JUMPY	454
	FIAT	ULYSSE	454
	FIAT COMM	SCUDO	454
	LANCIA	ZETA	454
	PEUGEOT	106	454
	PEUGEOT	106	454
	PEUGEOT	806	454
8571	PEUGEOT	EXPERT	454
	CITROEN COMM	JUMPER	158
	FIAT COMM	DUCATO (Mod. 94)	158
8572	PEUGEOT	BOXER	158
	FIAT	CROMA	158
8573	LANCIA	THEMA	158
	CITROEN	C8	453
	CITROEN	EVASION	453
	CITROEN COMM	JUMPY	453



	Costruttore Car Manufacturers		N° Figura Drawing N°
8573	FIAT	ULYSSE	453
	FIAT	ULYSSE II	453
	FIAT COMM	SCUDO	453
	LANCIA	PHEDRA	453
	LANCIA	ZETA	453
	PEUGEOT	806	453
	PEUGEOT	807	453
	PEUGEOT	EXPERT	453
8574	LANCIA	KAPPA	158
8575	CITROEN	BX	234
8576	RENAULT	TWINGO	453
8577	CITROEN	XANTIA	454
8578	FORD	ESCORT (90 - 95) Berl	447
	FORD	ESCORT (90 - 95) Berl	447
	FORD	ESCORT (90 - 95) SW	447
	FORD	ORION (90-93)	447
8579	FORD	ESCORT (90 - 95) Berl	448
	FORD	ESCORT (90 - 95) Berl	448
	FORD	ESCORT (90 - 95) SW	448
	FORD	ORION (90-93)	448
8580	FORD	ESCORT (90 - 95) Berl	482
	FORD	ESCORT (90 - 95) Berl	482
	FORD	ORION (90-93)	482
	FORD	ORION (90-93)	482
8581	FORD	ESCORT (90 - 95) Berl	482
	FORD	ESCORT (90 - 95) Berl	482
	FORD	ESCORT (90 - 95) Berl	482
8582	FORD	ESCORT (95-)	448
8583	FORD	ESCORT (95-)	447
8584	FORD	ESCORT (95-)	484
8585	FORD	ESCORT (95-)	484
8586	FORD	ESCORT (90 - 95) Berl	502
	FORD	ESCORT (95-)	502
8587	FORD	ESCORT (90 - 95) SW	482
8600	FORD	ESCORT (90 - 95) SW	483
	FORD	GRANADA	483
	FORD	SIERRA	483
	FORD	P100	483
8601	FORD	ESCORT (90 - 95) SW	1
8602	FORD	ESCORT (90 - 95) SW	2
8603	RENAULT	R9 - R11	453
	RENAULT	R9 - R11	453
	RENAULT	R9 - R11	453
	RENAULT	R9 - R11	453
	RENAULT	R9 - R11	453
8604	FORD	FIESTA 89-95	506
	FORD	FIESTA 95-02	506
	FORD	PUMA	506
	MAZDA	121	506
8605	FORD	FIESTA 89-95	482



	Costruttore Car Manufacturers		N° Figura Drawing N°
8605	FORD	PUMA	482
8606	FIAT	PALIO	158
8607	FORD	FIESTA 95-02	484
	FORD	PUMA	484
	MAZDA	121	484
8608	FORD	FOCUS	206
8609	FORD	FOCUS	202
8610	FORD	KA	506
8611	FIAT	PALIO	158
	LANCIA	MUSA	158
	LANCIA	YPSILON (MOD. 2003)	158
8612	FORD	KA	484
	FORD	PUMA	484
8613	FIAT	PALIO	156
8614	OPEL	ASTRA F	110
	OPEL	CALIBRA	110
	SAAB	900	110
	SAAB	9-3 (YS3D)	110
	SAAB	9-3 (YS3F)	110
8615	CHEVROLET / DAEWOO	ESPERO	113
	CHEVROLET / DAEWOO	LANOS	113
	CHEVROLET / DAEWOO	NEXIA	113
	OPEL	CORSA B	113
	OPEL	TIGRA	113
	OPEL COMM	COMBO	113
8616	AUDI	A3	244
	SEAT	LEON (1M1)	244
	SEAT	TOLEDO II	244
	SKODA	OCTAVIA I (1U2-1U5)	244
	VW	BORA	244
	VW	GOLF IV	244
	VW	NEW BEETLE	244
8617	OPEL	FRONTERA	216
8618	OPEL	FRONTERA	232
8619	OPEL	VECTRA B	112
8620	CITROEN	SAXO	454
	PEUGEOT	106	454
8621	IVECO	NEW DAILY	486
8622	PEUGEOT	206	465
8623	IVECO	NEW DAILY	486
8624	IVECO	DAILY	525
	IVECO	NEW DAILY	525
	IVECO	DAILY Heavy Duty	525
8625	PEUGEOT	306	454
8626	CITROEN	XSARA	156
	CITROEN	ZX	156
	PEUGEOT	306	156
8627	PEUGEOT	306	465
8628	PEUGEOT	406	49







	Costruttore Car Manufacturers		N° Figura Drawing N°
8629	PEUGEOT	406	49
8630	PEUGEOT	406	156
8631	RENAULT	LAGUNA I	454
8632	RENAULT	LAGUNA I	454
	RENAULT	R25	454
8633	RENAULT	MEGANE	454
	RENAULT	SCENIC	454
8634	VOLVO	440-460	40
	VOLVO	480	40
8635	RENAULT	CLIO I	453
	RENAULT	R19	453
	RENAULT	R21	453
	RENAULT	R21	453
8636	RENAULT	CLIO II	454
	RENAULT	TWINGO II	454
8637	RENAULT	CLIO I	467
	RENAULT	CLIO II	467
	RENAULT	R19	467
	RENAULT	TWINGO II	467
8638	RENAULT	SAFRANE II	454
	RENAULT	SAFRANE II	454
8639	RENAULT	SAFRANE I	454
	RENAULT	SAFRANE II	454
8640	RENAULT	R21	454
8641	RENAULT	R25	454
8642	SEAT	MARBELLA	144
	SEAT	TERRA	144
8643	SEAT	CORDOBA (6K2/C2)	156
	SEAT	IBIZA II-III (6K1)	156
	VW	CORRADO	156
	VW	GOLF III	156
	VW	VENTO	156
8644	SEAT	TOLEDO I	43
8645	FORD	MONDEO I-II	209
8646	FORD	MONDEO I-II	202
8647	FORD	MONDEO I-II	204
8648	FORD	MONDEO I-II	485
8649	FORD	MONDEO I-II	211
8686	FORD	MONDEO I-II	209
8687	FORD	FIESTA 95-02	506
	MAZDA	121	506
8688	FORD	ESCORT 80-86	199
8689	FORD	ESCORT (95-)	505
8690	FORD	FIESTA 89-96	508
8691	FORD	P100	12
	FORD	TRANSIT -91	12
	FORD	TRANSIT -91	12
	FORD	TRANSIT 91-	12
8692	VOLVO	850	40



	Costruttore Car Manufacturers		N° Figura Drawing N°
8692	VOLVO	940, 960	40
	VOLVO	C70	40
	VOLVO	S70	40
	VOLVO	V70 I	40
8693	BMW - MINI	Serie 3 (E21)	36
	BMW - MINI	Serie 3 (E30)	36
	BMW - MINI	Serie 3 (E36)	36
	BMW - MINI	Serie 5 (E12)	36
	BMW - MINI	Serie 5 (E28)	36
	BMW - MINI	Serie 5 (E34)	36
	BMW - MINI	Serie 6 (E24)	36
	BMW - MINI	Serie 7 (E23)	36
	BMW - MINI	Serie 7 (E32)	36
	BMW - MINI	Serie 8 (E31)	36
	BMW - MINI	Z3	36
	VOLVO	850	36
	VOLVO	C70	36
	VOLVO	S70	36
	VOLVO	V70 I	36
8694	MITSUBISHI	CARISMA	147
	MITSUBISHI	SPACE STAR	147
	VOLVO	S40 I	147
	VOLVO	V40	147
8695	BMW - MINI	Serie 5 (E12)	36
	BMW - MINI	Serie 6 (E24)	36
	BMW - MINI	Serie 7 (E23)	36
8696	FIAT	COUPE'	158
	FIAT	MAREA	158
8697	BEDFORD	MIDI	133
8698	FORD	TRANSIT -86	10
8699	FORD	TRANSIT 91-	11
8900	ALFA ROMEO	166	158
8901	ALFA ROMEO	166	158
8902	ALFA ROMEO	166	158
8903	AUDI	A1	242
	AUDI	A3	242
	AUDI	TT (8N3)	242
	SEAT	AROSA	242
	SEAT	CORDOBA (6K2/6K5)	242
	SEAT	CORDOBA (6L2)	242
	SEAT	IBIZA II-III (6K1)	242
	SEAT	IBIZA IV (6L1)	242
	SEAT	IBIZA V (6J5)	242
	SEAT	LEON (1M1)	242
	SEAT	TOLEDO II	242
	SKODA	FABIA (6Y_)	242
	SKODA	FABIA (Mod 2007)	242
	SKODA	OCTAVIA I (1U2-1U5)	242
	SKODA	ROOMSTER (5J)	242



	Costruttore Car Manufacturers		N° Figura Drawing N°
8903	VW	BORA	242
	VW	FOX	242
	VW	GOLF IV	242
	VW	LUPO	242
	VW	NEW BEETLE	242
	VW	POLO IV (9N_)	242
	VW	Polo V (6R) (06/09->)	242
8904	AUDI	A4 (-09/01)	55
8905	AUDI	A6 (Mod.97)	50
8906	AUDI	A6 (Mod.94)	40
8907	BMW - MINI	Serie 3 (E36)	58
	BMW - MINI	Z3	58
8908	BMW - MINI	Serie 3 (E36)	37
8909	BMW - MINI	Serie 3 (E36)	60
	BMW - MINI	Serie 3 (E46)	60
8910	BMW - MINI	Serie 3 (E46)	60
	BMW - MINI	Z4	60
8911	BMW - MINI	Serie 5 (E39)	58
8912	BMW - MINI	Serie 5 (E39)	43
8913	BMW - MINI	Serie 5 (E39)	40
8914	FORD	FIESTA 01-	351
	MAZDA	2	351
8915	FIAT	DOBLO'	158
8916	FIAT	DOBLO'	202
	FIAT	DOBLO'	202
8917	FIAT	BRAVO (Mod. 2007)	158
	FIAT	STILO	158
	LANCIA	DELTA (Mod. 2008)	158
8918	FIAT	STILO	158
8919	FIAT	STILO	156
8920	FIAT COMM	FIORINO (Mod.93)	158
8921	FIAT COMM	FIORINO (Mod.93)	156
8922	FORD	ESCORT (95-)	484
8923	FORD	FOCUS	205
8924	FORD	GALAXY	270
	SEAT	ALHAMBRA	270
	VW	SHARAN	270
8925	FORD	GALAXY	43
	SEAT	ALHAMBRA	43
	VW	SHARAN	43
8926	LANCIA	LYBRA	158
8927	MERCEDES	CLASSE A (W168)	62
8928	MERCEDES	CLASSE A (W168)	42
	MERCEDES	VANEO	42
8929	MERCEDES	CLASSE V	42
	MERCEDES	VITO (638)	42
8930	MERCEDES	CLASSE V	42
	MERCEDES	VITO (638)	42
8931	MERCEDES	SPRINTER (901/902/903)	54



	Costruttore Car Manufacturers		N° Figura Drawing N°
8931	MERCEDES	SPRINTER (901/902/903)	54
	MERCEDES	SPRINTER (904)	54
	VW	LT II	54
	VW	LT II	54
8932	OPEL	AGILA	259
	SUBARU	JUSTY III (G3X)	259
	SUZUKI	IGNIS II	259
	SUZUKI	WAGON R+ (MM)	259
8933	OPEL	AGILA	254
	SUZUKI	IGNIS (FH)	254
8934	OPEL	ASTRA G	74
	OPEL	ZAFIRA	74
8935	OPEL	ASTRA G	72
	OPEL COMM	COMBO	72
8936	OPEL	ASTRA G	74
	OPEL	ASTRA H	74
	OPEL	MERIVA	74
	OPEL	ZAFIRA	74
	OPEL	ZAFIRA II	74
8937	OPEL	CORSA C	75
	OPEL	TIGRA TWIN TOP	75
	OPEL COMM	COMBO	75
8938	OPEL	CORSA C	72
	OPEL	TIGRA TWIN TOP	72
8939	PEUGEOT	605	466
8940	PEUGEOT	C4	454
8941	PEUGEOT	C4	157
	CITROEN	C4 (Mod. 2009) - DS4	157
	PEUGEOT	308	157
	PEUGEOT	3008	157
	PEUGEOT	5008	157
8942	NISSAN	KUBISTAR	454
	NISSAN	KUBISTAR	454
	RENAULT	KANGOO	454
8943	RENAULT	KANGOO	454
8944	NISSAN	KUBISTAR	453
	RENAULT	KANGOO	453
8946	RENAULT comm	MASTER	158
8947	RENAULT comm	MASTER	158
8950	SUZUKI	VITARA	259
8951	SUZUKI	VITARA	15
	SUZUKI	VITARA	15
8952	SUZUKI	SJ 410, SJ 413, SANTANA	254
	SUZUKI	VITARA	254
8953	TOYOTA	AVENSIS (T22)	279
8954	TOYOTA	AVENSIS (T22)	279
8955	TOYOTA	AVENSIS (T22)	274
8956	TOYOTA	AVENSIS (T22)	274
8957	TOYOTA	YARIS I	288



	Costruttore Car Manufacturers		N° Figura Drawing N°
8957	TOYOTA	YARIS VERSO	288
8958	TOYOTA	YARIS I	288
	TOYOTA	YARIS VERSO	288
8959	TOYOTA	YARIS I	273
	TOYOTA	YARIS VERSO	273
8960	TOYOTA	COROLLA (E10)	278
8961	TOYOTA	COROLLA (E10)	278
8962	TOYOTA	COROLLA (E10)	273
8963	TOYOTA	COROLLA (E11)	278
8964	TOYOTA	COROLLA (E11)	278
8965	TOYOTA	COROLLA (E11)	273
8966	SEAT	AROSA	68
	VW	LUPO	68
	VW	POLO III (6N1, 6N2)	68
8967	VW	POLO III (6N1, 6N2)	267
	VW	POLO CLASSIC (6KV2), POLO VARIANT (6KV5)	267
8968	VW	PASSAT (3B2)	56
8969	SEAT	INCA	267
	VW	CADDY II	267
8970	FORD	FIESTA 01-	311
8971	VW	TRANSPORTER T4	50
	VW	TRANSPORTER T4	50
8972	VW	TRANSPORTER T4	50
	VW	TRANSPORTER T4	50
	VW	TRANSPORTER T4	50
	VW	TRANSPORTER T4	50
8974	VW	TRANSPORTER T4	50
8991	SKODA	FELICIA I-II (6U1-6U5)	156
8992	RENAULT	ESPACE II	454
8993	NISSAN	MICRA (K11)	297
8994	NISSAN	MICRA (K11)	294
8995	NISSAN	MICRA (K11)	296
8996	NISSAN	MICRA (K11)	297
8998	FORD	MONDEO III	203
8999	FORD	MONDEO III	208
80000	FORD	FUSION	312
80001	FORD	FUSION	311
80002	CITROEN	ZX	158
	PEUGEOT	205	158
	PEUGEOT	309	158
80003	CITROEN	C2	454
	CITROEN	C3	454
80004	CITROEN	C2	157
	CITROEN	C3	157
	PEUGEOT	1007	157
80005	CITROEN	C5	454
80006	CITROEN	C5	453
80007	CITROEN	C8	454
	FIAT	ULYSSE II	454



	Costruttore Car Manufacturers		N° Figura Drawing N°
80007	LANCIA	PHEDRA	454
	PEUGEOT	807	454
80008	SEAT	CORDOBA (6L2)	317
	SEAT	IBIZA IV (6L1)	317
	SKODA	FABIA (6Y_)	317
	SKODA	FABIA (Mod 2007)	317
	SKODA	ROOMSTER (5J)	317
	VW	FOX	317
	VW	POLO IV (9N_)	317
80009	RENAULT	ESPACE IV	309
	RENAULT	LAGUNA II	309
	RENAULT	VELSATIS	309
80010	RENAULT	ESPACE IV	310
	RENAULT	LAGUNA II	310
80011	CHEVROLET / DAEWOO	MATIZ	308
	CHEVROLET / DAEWOO	MATIZ	308
80012	CHEVROLET / DAEWOO	MATIZ	307
	CHEVROLET / DAEWOO	MATIZ	307
80013	CHEVROLET / DAEWOO	NUBIRA I-II	115
	CHEVROLET / DAEWOO	TACUMA (REZZO)	115
80014	CHEVROLET / DAEWOO	NUBIRA I-II	109
80015	CHEVROLET / DAEWOO	NUBIRA I-II	109
80016	CHEVROLET / DAEWOO	NUBIRA I-II	116
80017	CHEVROLET / DAEWOO	NUBIRA I-II	116
80018	HONDA	ACCORD III	184
80019	HONDA	ACCORD III	184
80020	HONDA	ACCORD III	183
	HONDA	ACCORD IV	183
	HONDA	CIVIC IV	183
	HONDA	CIVIC V	183
	HONDA	CRX II	183
	HONDA	CRX III	183
80021	HONDA	ACCORD III	186
	HONDA	ACCORD IV	186
80022	HONDA	CIVIC III	186
	HONDA	CIVIC IV	186
	HONDA	CRX II	186
	HONDA	CRX III	186
80023	HONDA	CIVIC III	186
	HONDA	CRX II	186
80024	HONDA	CIVIC III	186
	HONDA	CIVIC IV	186
	HONDA	CRX II	186
80025	HONDA	CRX III	186
	HONDA	CIVIC III	183
80026	HYUNDAI	ATOS	148
80027	HYUNDAI	ATOS	148
80028	HYUNDAI	ATOS	148
80029	HYUNDAI	ATOS	267



	Costruttore Car Manufacturers		N° Figura Drawing N°	
80030	HYUNDAI	ATOS	267	
80031	JEEP	CHEROKEE (XJ)	449	
	JEEP	G.CHEROKEE	449	
80032	JEEP	CHEROKEE (XJ)	450	
	JEEP	G.CHEROKEE	450	
80033	JEEP	CHEROKEE (XJ)	362	
80036	JEEP	WRANGLER	394	
80037	MAZDA	323 F	322	
	MAZDA	323 F	322	
	MAZDA	323 S	322	
	MAZDA	323 S	322	
	MAZDA	626 S	322	
	MAZDA	MX3	322	
80038	MAZDA	323 F	319	
	MAZDA	323 S	319	
80039	MAZDA	323 BJ	350	
	MAZDA	primacy	350	
80040	MAZDA	323 BJ	319	
	MAZDA	primacy	319	
80041	MAZDA	626 S	333	
80042	MAZDA	626 (GF)(SW	322	
80043	MAZDA	626 (GF)(SW	323	
80044	MITSUBISHI	COLT I-II	200	
	MITSUBISHI	COLT III	200	
	MITSUBISHI	CORDIA	200	
	MITSUBISHI	GALANT II (A16 )	200	
	MITSUBISHI	GALANT III (E1 A )	200	
	MITSUBISHI	GALANT IV (E3 A )	200	
	MITSUBISHI	L200	200	
	MITSUBISHI	LANCER II	200	
	MITSUBISHI	LANCER III	200	
	MITSUBISHI	LANCER IV	200	
	MITSUBISHI	LANCER V	200	
	MITSUBISHI	LANCER V	200	
	MITSUBISHI	SAPPORO III (E16A)	200	
	MITSUBISHI	SIGMA (F16A)	200	
	MITSUBISHI	SPACE RUNNER (N1, N2)	200	
	MITSUBISHI	SPACE WAGON (DO W)	200	
	MITSUBISHI	SPACE WAGON (N3, N4)	200	
	MITSUBISHI	TREDIA	200	
	80045	MITSUBISHI	COLT I-II	238
		MITSUBISHI	COLT III	238
MITSUBISHI		CORDIA	238	
MITSUBISHI		ECLIPSE I (D2 A)	238	
MITSUBISHI		GALANT II (A16 )	238	
MITSUBISHI		GALANT III (E1 A )	238	
MITSUBISHI		GALANT IV (E3 A )	238	
MITSUBISHI		L200	238	
MITSUBISHI		L200	238	



	Costruttore Car Manufacturers		N° Figura Drawing N°	
80045	MITSUBISHI	L 300 (P0__)	238	
	MITSUBISHI	L200	238	
	MITSUBISHI	LANCER	238	
	MITSUBISHI	LANCER III	238	
	MITSUBISHI	LANCER IV	238	
	MITSUBISHI	LANCER V	238	
	MITSUBISHI	PAJERO II	238	
	MITSUBISHI	SAPPORO III (E16A)	238	
	MITSUBISHI	SAPPORO III (E16A)	238	
	MITSUBISHI	SPACE RUNNER (N1, N2)	238	
	MITSUBISHI	SPACE WAGON (DO W)	238	
	MITSUBISHI	SPACE WAGON (N3, N4)	238	
	MITSUBISHI	STARION	238	
	MITSUBISHI	TREDIA	238	
	80046	HYUNDAI	GALLOPER I-II	200
		MITSUBISHI	COLT I-II	200
MITSUBISHI		CORDIA	200	
MITSUBISHI		L 300 (L0__)	200	
MITSUBISHI		LANCER III	200	
MITSUBISHI		SPACE RUNNER (N1, N2)	200	
MITSUBISHI		SPACE WAGON (DO W)	200	
MITSUBISHI		SPACE WAGON (N3, N4)	200	
MITSUBISHI		STARION	200	
MITSUBISHI		TREDIA	200	
80047	MITSUBISHI	COLT III	200	
	MITSUBISHI	GALANT III (E1 A )	200	
	MITSUBISHI	LANCER IV	200	
	MITSUBISHI	PAJERO II	200	
	MITSUBISHI	PAJERO II	200	
	MITSUBISHI	SAPPORO III (E16A)	200	
	80048	MITSUBISHI	GALANT IV (E3 A )	200
MITSUBISHI		L200	200	
80049	MITSUBISHI	L200	200	
	MITSUBISHI	L 300 (L0__)	200	
	MITSUBISHI	PAJERO I	200	
80050	MITSUBISHI	L 300 (L0__)	200	
	MITSUBISHI	L 300 (P0__)	200	
	MITSUBISHI	L200	200	
80051	MITSUBISHI	PAJERO I	200	
	MITSUBISHI	SPACE WAGON (DO W)	200	
	MITSUBISHI	TREDIA	200	
80052	MITSUBISHI	PAJERO I	200	
80053	NISSAN	100NX	217	
	NISSAN	SUNNY II (N13)	217	
	NISSAN	SUNNY II (N13)	217	
	NISSAN	SUNNY (Y10)	217	
	NISSAN	SUNNY (Y10)	217	
80054	NISSAN	100NX	91	
	NISSAN	SUNNY II (N13)	91	

	Costruttore Car Manufacturers		N° Figura Drawing N°
80054	NISSAN	SUNNY II (N13)	91
	NISSAN	SUNNY (Y10)	91
	NISSAN	SUNNY (Y10)	91
80055	NISSAN	ALMERA	214
80056	NISSAN	ALMERA	91
80057	NISSAN	ALMERA	217
80058	NISSAN	ALMERA	212
80059	NISSAN	BLUEBIRD (T12)	220
	NISSAN	BLUEBIRD (U11) WAGON (WU11)	220
80060	NISSAN	BLUEBIRD (T12)	221
	NISSAN	BLUEBIRD (U11) WAGON (WU11)	221
80061	NISSAN	BLUEBIRD (U11) WAGON (WU11)	222
80062	NISSAN	BLUEBIRD (U11) WAGON (WU11)	223
80063	NISSAN	BLUEBIRD (T12)	212
	NISSAN	BLUEBIRD (U11) WAGON (WU11)	212
80064	NISSAN	MICRA (K10)	214
80065	NISSAN	MICRA (K10)	217
80066	NISSAN	MICRA (K10)	254
80071	NISSAN	PATROL GR (Y60)	255
80072	NISSAN	PATROL GR (Y60)	228
80073	NISSAN	PATROL GR (Y60)	214
80074	NISSAN	PATROL HARDTOP (K160)	261
	NISSAN	PATROL STATION WAGON (W160)	261
	NISSAN	URVAN	261
	NISSAN	CABSTAR	261
80075	NISSAN	PATROL HARDTOP (K160)	441
	NISSAN	PATROL STATION WAGON (W160)	441
80076	NISSAN	PATROL HARDTOP (K160)	238
80077	NISSAN	PICK UP (720)	219
80078	NISSAN	PICK UP (720)	92
80079	NISSAN	PICK UP (720)	238
80080	NISSAN	100NX	254
	NISSAN	PICK UP (720)	254
	NISSAN	SUNNY II (N13)	254
	NISSAN	SUNNY II (N13)	254
80081	NISSAN	PICK UP (720)	237
80082	NISSAN	KING CAB (D21)	92
80083	NISSAN	KING CAB (D21)	219
80084	NISSAN	KING CAB (D21)	13
	NISSAN	TERRANO (WD21)	13
	NISSAN	TERRANO II	13
80085	NISSAN	KING CAB (D21)	18
	NISSAN	TERRANO (WD21)	18
	NISSAN	TERRANO II	18
80086	NISSAN	PRAIRIE (M11)	229
80087	NISSAN	PRAIRIE (M11)	212
80088	NISSAN	PRIMERA (P10)	229
80089	NISSAN	PRIMERA (P10)	298
80090	NISSAN	PRIMERA (P10)	294



	Costruttore Car Manufacturers		N° Figura Drawing N°
80091	NISSAN	PRIMERA (P11)	94
80092	NISSAN	PRIMERA (P11)	299
80093	NISSAN	PRIMERA (P11)	295
80094	NISSAN	PRIMERA (P11)	295
80095	NISSAN	SERENA	224
80096	NISSAN	SERENA	255
80097	NISSAN	SUNNY II (N13)	225
80098	NISSAN	PRAIRIE (M11)	212
	NISSAN	SUNNY II (N13)	212
	NISSAN	SUNNY II (N13)	212
	NISSAN	SUNNY II (N13)	212
80099	NISSAN	SUNNY II (N13)	226
80100	NISSAN	PRIMERA (W10)	212
	NISSAN	SUNNY (Y10)	212
	NISSAN	SUNNY (Y10)	212
80101	NISSAN	TERRANO (WD21)	238
80102	NISSAN	TERRANO II	255
80103	NISSAN	VANETTE BUS	227
80105	NISSAN	VANETTE BUS	218
	NISSAN	VANETTE VAN	218
80106	NISSAN	VANETTE BUS	218
	NISSAN	VANETTE VAN	218
80107	NISSAN	VANETTE BUS	201
	NISSAN	VANETTE VAN	201
80108	SUBARU	JUSTY II (JMA, MS)	260
	SUZUKI	SWIFT II	260
	SUZUKI	SWIFT II	260
80109	SUBARU	JUSTY II (JMA, MS)	254
	SUBARU	IMPREZA (GF)	336
	SUBARU	LEGACY I (BC) SW (BJF)	336
80111	SUBARU	LEGACY II (BD-BG)	336
	SUBARU	IMPREZA (GF)	336
	SUBARU	LEGACY I (BC) SW (BJF)	336
80112	SUBARU	LEGACY II (BD-BG)	336
	SUBARU	IMPREZA (GF)	334
	SUBARU	LEGACY I (BC) SW (BJF)	334
80113	SUBARU	LEGACY II (BD-BG)	334
	SUBARU	LEGACY I (BC) SW (BJF)	337
	SUBARU	LEGACY II (BD-BG)	337
80114	SUBARU	LEGACY I (BC) SW (BJF)	337
	SUBARU	LEGACY II (BD-BG)	337
80115	SUBARU	LEONE	336
80116	SUBARU	LEONE	196
80117	SUZUKI	ALTO II (EC)	256
80118	SUZUKI	ALTO II (EC)	254
	SUZUKI	ALTO III (EF)	254
	SUZUKI	ALTO IV (FF)	254
80119	SUZUKI	ALTO III (EF)	254



	Costruttore Car Manufacturers		N° Figura Drawing N°
80120	SUZUKI	BALENO	260
80121	SUZUKI	ALTO IV (FF)	254
	SUZUKI	BALENO	254
	SUZUKI	LIANA	254
	SUZUKI	WAGON R+ (EM)	254
	SUZUKI	WAGON R+ (EM)	254
80122	SUZUKI	SWIFT II	260
	SUZUKI	SWIFT II	260
	SUZUKI	SWIFT II	260
	SUZUKI	SWIFT II CABRIO	260
80123	SUZUKI	SWIFT II	254
	SUZUKI	SWIFT II	254
	SUZUKI	SWIFT II	254
	SUZUKI	SWIFT II CABRIO	254
80124	SUZUKI	SWIFT II	256
	SUZUKI	SWIFT II	256
80125	TOYOTA	CARINA II	195
80126	TOYOTA	CARINA II	137
80127	TOYOTA	CARINA E	278
	TOYOTA	PICNIC (_XM10)	278
80128	TOYOTA	CARINA E	278
	TOYOTA	PICNIC (_XM10)	278
80129	TOYOTA	CARINA E	275
80130	TOYOTA	CARINA E	275
80131	TOYOTA	CELICA (AT162)	140
	TOYOTA	COROLLA (E8)	140
80132	TOYOTA	CELICA (AT162)	137
80133	TOYOTA	COROLLA (E8)	192
80134	TOYOTA	COROLLA (E9)	140
80135	TOYOTA	HIACE II (H5_)	137
80136	TOYOTA	HIACE II (H5_)	238
80137	TOYOTA	HIACE III (H10_)	139
80138	TOYOTA	HIACE III (H10_)	141
80139	TOYOTA	HIACE III (H10_)	193
	TOYOTA	HIACE III (H10_)	193
80140	TOYOTA	HIACE III (H10_)	193
	TOYOTA	LAND CRUISER (_J6_)	193
80141	TOYOTA	HIACE IV (H1 , H2)	289
80142	TOYOTA	HIACE IV (H1 , H2)	290
80143	TOYOTA	HIACE IV (H1 , H2)	273
80144	TOYOTA	HILUX Pickup (_N_)	137
80145	TOYOTA	4 RUNNER (N130)	138
	TOYOTA	4 RUNNER	138
	TOYOTA	HILUX Pickup (_N_)	138
	TOYOTA	HILUX Pickup (_N_)	138
80146	TOYOTA	HILUX Pickup (_N_)	193
	TOYOTA	LAND CRUISER (_J7_)	193
80147	TOYOTA	LAND CRUISER (_J6_)	193
	TOYOTA	LAND CRUISER (_J7_)	193
80148	TOYOTA	LAND CRUISER (_J6_)	193

	Costruttore Car Manufacturers		N° Figura Drawing N°
80149	KIA	SEPHIA	346
	KIA	SHUMA	346
80150	KIA	SEPHIA	345
80151	KIA	CARENS I	349
	KIA	CARENS II	349
	KIA	SEPHIA	349
	KIA	SHUMA	349
80152	KIA	SPORTAGE I	16
80153	KIA	SPORTAGE I	17
80154	KIA	SPORTAGE I	321
80159	FIAT	ULYSSE	454
	LANCIA	ZETA	454
80160	AUDI	A3 (Mod. 2003)	317
	SEAT	ALTEA	317
	SEAT	ALTEA	317
	SEAT	LEON II (1P1)	317
	SEAT	TOLEDO II	317
	SKODA	OCTAVIA II (1Z3-1Z5)	317
	SKODA	SUPERB II (3T4)	317
	SKODA	YETI	317
	VW	EOS	317
	VW	GOLF V	317
	VW	GOLF V PLUS	317
	VW	GOLF VI	317
	VW	JETTA III	317
	VW	SCIROCCO (137)	317
	VW	TOURAN	317
	VW	CADDY III	317
80161	AUDI	A3 (Mod. 2003)	316
	SEAT	ALTEA	316
	SEAT	ALTEA	316
	SEAT	LEON II (1P1)	316
	SEAT	TOLEDO II	316
	SKODA	OCTAVIA II (1Z3-1Z5)	316
	SKODA	SUPERB II (3T4)	316
	VW	GOLF V	316
	VW	GOLF V PLUS	316
	VW	JETTA III	316
80162	VW	PASSAT (3C2)	316
	VW	TOURAN	316
	VW	CADDY III	316
	VW	CADDY III	316
80163	AUDI	A8 (94-02)	50
	VW	PASSAT (3B3)	50
80164	AUDI	A6 (Mod.2004)	50
80165	AUDI	A6 (Mod.2004)	52
80166	VW	LUPO	68
80167	VW	MULTIVAN	53
	VW	TRANSPORTER T5	53



	Costruttore Car Manufacturers		N° Figura Drawing N°
80168	VW	MULTIVAN	50
	VW	TRANSPORTER T5	50
80169	AUDI	Q7	61
	PORSCHE	CAYENNE (955)	61
	VW	TOUAREG	61
80170	AUDI	Q7	61
	PORSCHE	CAYENNE (955)	61
	VW	TOUAREG	61
80171	AUDI	A4 (mod.2001)	50
	AUDI	A4 (mod.2004)	50
	SEAT	EXEO	50
80172	AUDI	A2	244
80173	AUDI	A2	242
80174	FIAT	500 (MOD. 2007)	156
	FIAT	PANDA (MOD. 2003)	156
	FIAT	PANDA (MOD. 2003)	156
	FIAT	Panda (Mod.2012)	156
80175	LANCIA	THESIS	158
80176	FIAT	500 (MOD. 2007)	158
	FIAT	LINEA	158
	FIAT	PANDA (MOD. 2003)	158
80177	CITROEN COMM	JUMPER (Mod. 2002)	158
	FIAT COMM	DUCATO (Mod. 2002)	158
	PEUGEOT	BOXER (Mod. 2002)	158
80178	LANCIA	YPSILON (MOD. 2003)	158
80179	LANCIA	THESIS	158
80180	FIAT	PANDA (MOD. 2003)	158
80181	FIAT	CROMA (Mod.2005)	158
80182	FIAT	PANDA (MOD. 2003)	158
80183	CITROEN COMM	JUMPER (Mod. 2002)	158
	FIAT COMM	DUCATO (Mod. 2002)	158
	PEUGEOT	BOXER (Mod. 2002)	158
80184	FIAT	IDEA	158
	LANCIA	MUSA	158
80185	ALFA ROMEO	159	158
80186	ALFA ROMEO	MITO	158
	FIAT	500L (09/2012->)	158
	FIAT	PUNTO (Mod 2005 - Grande Punto)	158
	FIAT	PUNTO Evo	158
	FIAT	Punto MY2012	158
	OPEL	CORSA D	158
80187	FIAT	PUNTO (Mod 2005 - Grande Punto)	156
	FIAT	PUNTO Evo	156
	FIAT	Punto MY2012	156
80188	CITROEN COMM	NEMO	158
	FIAT	LINEA	158
	FIAT	PUNTO (Mod 2005 - Grande Punto)	158
	FIAT	QUBO	158
	FIAT COMM	FIORINO (Mod 2008)	158



	Costruttore Car Manufacturers		N° Figura Drawing N°
80188	OPEL	CORSA D	158
80189	ALFA ROMEO	159	158
	ALFA ROMEO	BRERA	158
80190	FORD	KA	506
80191	FORD	KA	484
80192	MERCEDES	CLASSE M (W163)	62
80193	MERCEDES	CLASSE A (W168)	42
	MERCEDES	CLASSE A (W169)	42
	MERCEDES	CLASSE B (W245)	42
	MERCEDES	VANEO	42
80194	MERCEDES	CLASSE A (W169)	62
	MERCEDES	CLASSE B (W245)	62
80195	MERCEDES	CLASSE CLS (C219)	62
	MERCEDES	CLASSE E (W211)	62
80196	MERCEDES	CLASSE CLS (C219)	62
	MERCEDES	CLASSE E (W211)	62
	MERCEDES	CLASSE S (W220)	62
80197	MERCEDES	VANEO	62
80198	MCC (SMART)	ROADSTER	158
	MCC (SMART)	City Coupe' (MC01)	158
80200	NISSAN	PRIMASTAR	454
	OPEL COMM	VIVARO	454
	RENAULT comm	TRAFIC II	454
80201	NISSAN	PRIMASTAR	453
	OPEL COMM	VIVARO	453
	RENAULT comm	TRAFIC II	453
80203	PEUGEOT	607	454
80204	PEUGEOT	607	454
80205	PEUGEOT	406	454
80206	NISSAN comm	INTERSTAR	454
	OPEL COMM	MOVANO	454
	RENAULT comm	MASTER II-III	454
80207	OPEL COMM	MOVANO	454
	RENAULT comm	MASTER II-III	454
80208	NISSAN comm	INTERSTAR	454
	OPEL COMM	MOVANO	454
	RENAULT comm	MASTER II-III	454
80211	NISSAN comm	INTERSTAR	454
	OPEL COMM	MOVANO	454
	RENAULT comm	MASTER II-III	454
80212	RENAULT	CLIO III	454
	RENAULT	MODUS	454
80213	RENAULT	MEGANE II	454
	RENAULT	SCENIC II	454
80214	RENAULT	CLIO III	453
	RENAULT	MODUS	453
80215	VOLVO	S60	43
	VOLVO	S80	43
	VOLVO	V70 II	43



	Costruttore Car Manufacturers		N° Figura Drawing N°
80216	VOLVO	S40 II	203
	VOLVO	V50	203
80217	VOLVO	S60	40
	VOLVO	S80	40
	VOLVO	V70 II	40
80222	MAZDA	6	325
80227	CITROEN	BERLINGO	157
	CITROEN	PICASSO	157
	PEUGEOT	RANCH / PARTNER	157
80228	VW	MULTIVAN	53
	VW	TRANSPORTER T5	53
80229	SUZUKI	SJ 410, SJ 413, SANTANA	260
80230	SUZUKI	GRAND VITARA (FT-GT)	256
80231	FORD	ESCORT (95-)	447
80232	BMW - MINI	Sere 1 (E87)	57
80233	FORD	ESCORT (95-)	448
80234	FORD	MONDEO I-II	314
80235	MERCEDES	SPRINTER (901/902/903)	54
	MERCEDES	SPRINTER (904)	54
	VW	LT II	54
80236	MERCEDES	CLASSE C (W202)	62
	MERCEDES	CLASSE C (W203)	62
	MERCEDES	CLASSE CLK (C208)	62
	MERCEDES	CLASSE CLK (C209)	62
	MERCEDES	CLASSE E (W210)	62
	MERCEDES	CLASSE S (W140)	62
	MERCEDES	CLASSE S (W220)	62
	MERCEDES	CLASSE SL (R129)	62
	MERCEDES	CLASSE SLK (R170)	62
80237	OPEL	FRONTERA	215
80238	BMW - MINI	Serie 5 (E39)	36
	BMW - MINI	Serie 7 (E38)	36
	BMW - MINI	Serie 8 (E31)	36
80239	NISSAN	PRIMERA (P11)	294
80240	MERCEDES	CLASSE G (W461)	104
	MERCEDES	CLASSE G (W463)	104
80241	VOLVO	C70	36
	VOLVO	S70	36
	VOLVO	V70 I	36
	VOLVO	V70 II	36
80242	MERCEDES	SPRINTER (904)	50
	VW	LT II	50
80243	CITROEN COMM	JUMPER (Mod. 2006)	158
	FIAT COMM	DUCATO (Mod. 2006)	158
	FIAT Commercial	Ducato MY2011	158
	PEUGEOT	BOXER (Mod. 2006)	158
80244	FORD	GALAXY	39
	SEAT	ALHAMBRA	39
	VW	SHARAN	39



	Costruttore Car Manufacturers		N° Figura Drawing N°
80245	MERCEDES	SPRINTER (901/902/903)	54
	MERCEDES	SPRINTER (904)	54
	MERCEDES	SPRINTER (906)	54
	MERCEDES	SPRINTER (906)	54
	VW	CRAFTER	54
	VW	CRAFTER	54
	VW	LT II	54
80246	FORD	C-MAX I	209
	FORD	FOCUS II	209
80247	SEAT	TOLEDO I	39
	VW	GOLF II	39
	VW	JETTA II	39
80248	AUDI	A6 (Mod.97)	56
	VW	PASSAT (3B2)	56
	VW	PASSAT (3B3)	56
80249	MERCEDES	SPRINTER (904)	50
	VW	LT II	50
80250	MERCEDES	VIANO	62
	MERCEDES	VITO (639)	62
80251	MERCEDES	VIANO	65
	MERCEDES	VITO (639)	65
80252	NISSAN	PRIMASTAR	454
	OPEL COMM	VIVARO	454
	RENAULT comm	TRAFIC II	454
80253	MERCEDES	VANEO	61
80254	AUDI	A4 (mod.2001)	69
	AUDI	A4 (mod.2004)	69
	SEAT	EXEO	69
80255	VW	LT I	104
80256	SKODA	FELICIA I-II (6U1-6U5)	270
80257	RENAULT	ESPACE III	454
80258	FORD	GALAXY	51
	SEAT	ALHAMBRA	51
	VW	SHARAN	51
80259	SUZUKI	ALTO IV (FF)	236
80260	OPEL	FRONTERA	257
80261	FORD	TRANSIT - TOURNEO CONNECT	206
80262	FIAT	500 (MOD. 2007)	158
	FIAT	Panda (Mod.2012)	158
	FIAT	YPSILON (MOD. 2011)	158
80263	FORD	TRANSIT - TOURNEO CONNECT	206
80264	BMW - MINI	Sere 1 (E87)	58
80265	CITROEN	XANTIA	454
80266	BMW - MINI	Sere 1 (E87)	58
	BMW - MINI	Serie 3 (E90)	58
80267	FORD	FOCUS	206
80268	NISSAN	SERENA	213
80269	LANDROVER	DEFENDER	492
	LANDROVER	DEFENDER	492







	Costruttore Car Manufacturers		N° Figura Drawing N°
80269	LANDROVER	DEFENDER	492
80270	SUBARU	JUSTY III (G3X)	254
	SUZUKI	IGNIS II	254
	SUZUKI	WAGON R+ (MM)	254
80271	SUZUKI	WAGON R+ (EM)	254
80272	NISSAN	KING CAB (D21)	255
80273	NISSAN	ALMERA TINO	214
80274	ROVER	SERIE 400	185
	ROVER	SERIE 400	185
80275	AUDI	TT (8N3)	244
	VW	NEW BEETLE	244
80276	SUZUKI	ALTO IV (FF)	240
80277	OPEL	ASTRA H	74
	OPEL	MERIVA B	74
	OPEL	ZAFIRA II	74
80278	SUZUKI	ALTO IV (FF)	241
80279	SUZUKI	LIANA	259
80280	SUZUKI	GRAND VITARA (FT-GT)	254
80281	BMW - MINI	Serie 5 (E60)	59
80282	MERCEDES	CLASSE S (W140)	46
80283	HONDA	CRV I	183
	HONDA	CRV II	183
	HONDA	LOGO	183
80284	CITROEN COMM	JUMPER (Mod. 2006)	380
	FIAT COMM	DUCATO (Mod. 2006)	380
	FIAT Commercial	Ducato MY2011	380
	PEUGEOT	BOXER (Mod. 2006)	380
80285	CITROEN COMM	JUMPER (Mod. 2006)	380
	FIAT COMM	DUCATO (Mod. 2006)	380
	PEUGEOT	BOXER (Mod. 2006)	380
80286	TOYOTA	LAND CRUISER (_J9_)	273
80287	TOYOTA	PREVIA (ACR3_)	273
80288	CHEVROLET / DAEWOO	LACETTI	116
	CHEVROLET / DAEWOO	NUBIRA III (Mod 2003)	116
80289	VOLVO	C70	42
	VOLVO	S70	42
	VOLVO	V70 I	42
	VOLVO	V70 II	42
80290	CHEVROLET / DAEWOO	EVANDA	114
80291	HONDA	ACCORD VI	185
	ROVER	SERIE 600	185
80292	CHEVROLET / DAEWOO	LACETTI	114
	CHEVROLET / DAEWOO	NUBIRA III (Mod 2003)	114
80293	CHEVROLET / DAEWOO	TACUMA (REZZO)	109
80294	BMW - MINI	X5 (E53)	59
80295	HONDA	HRV	183
80296	CHEVROLET / DAEWOO	KALOS	307
80297	TOYOTA	PICNIC (_XM10)	273
80298	FIAT	SEDICI	254



	Costruttore Car Manufacturers		N° Figura Drawing N°
80298	SUZUKI	SX4	254
80299	MERCEDES	CLASSE G (W461)	106
	MERCEDES	CLASSE G (W463)	106
80300	HONDA	CIVIC V	185
80301	VOLVO	C70	42
	VOLVO	S70	42
	VOLVO	V70 I	42
	VOLVO	V70 I	42
80302	TOYOTA	PICNIC (_XM10)	273
80303	CITROEN COMM	NEMO	379
	FIAT	LINEA	379
	FIAT COMM	FIORINO (Mod 2008)	379
80304	HONDA	CIVIC V	183
80305	BMW - MINI	X3 (E83)	59
80306	FORD	C-MAX I	207
	FORD	FOCUS II	207
	FORD	FOCUS II (Restyling 2008->)	207
80307	FORD	MONDEO I-II	507
80308	BMW - MINI	Serie 3 (E36)	59
80309	RENAULT	MEGANE II	452
	RENAULT	SCENIC II	452
80310	TOYOTA	CAMRY (V20)	275
80311	HYUNDAI	GETZ	267
80312	CHEVROLET / DAEWOO	LACETTI	114
	CHEVROLET / DAEWOO	NUBIRA III (Mod 2003)	114
80313	HONDA	ACCORD V	183
	ROVER	SERIE 600	183
80314	CHEVROLET / DAEWOO	TACUMA (REZZO)	114
80315	TOYOTA	RAV 4 I (SXA1)	273
80316	HYUNDAI	MATRIX	145
80317	AUDI	A8 (94-02)	42
	AUDI	A8 (94-02)	42
80318	FIAT COMM	SCUDO (Mod. 2007)	467
80319	CITROEN	C3 Picasso	467
	PEUGEOT	207	467
	PEUGEOT	208	467
80320	BMW - MINI	Serie 3 (E36)	42
80321	FORD	C-MAX I	207
	FORD	C-MAX I	207
	FORD	C-MAX II	207
	FORD	FOCUS II	207
	FORD	FOCUS II	207
80322	CHEVROLET / DAEWOO	LACETTI	116
	CHEVROLET / DAEWOO	NUBIRA III (Mod 2003)	116
80323	TOYOTA	PASEO	273
	TOYOTA	STARLET (EP91)	273
80324	TOYOTA	COROLLA VERSO (E12J)	277
80325	HYUNDAI	ACCENT II	145



	Costruttore Car Manufacturers		N° Figura Drawing N°
80326	TOYOTA	CAMRY (V20)	275
80327	CHEVROLET / DAEWOO	TACUMA (REZZO)	109
80328	mitsubishi	L200	245
	mitsubishi	PAJERO II	245
80329	FIAT COMM	SCUDO (Mod. 2007)	467
80330	BMW - MINI	Sere 1 (E87)	60
	BMW - MINI	Serie 3 (E90)	60
	BMW - MINI	Serie 3 (F30)	60
	BMW - MINI	X1 (E84)	60
80331	BMW - MINI	Serie 7 (E38)	42
80332	HONDA	ACCORD V	184
	ROVER	SERIE 600	184
80333	OPEL COMM	COMBO	99
	OPEL COMM	KADETT E - KOMBI	99
80334	OPEL	OMEGA B	117
80335	FIAT	BRAVO (Mod. 2007)	158
	LANCIA	DELTA (Mod. 2008)	158
80336	BMW - MINI	Serie 7 (E38)	59
80337	HONDA	ACCORD V	184
	ROVER	SERIE 600	184
80338	MERCEDES	MB 100 D	121
80339	ROVER	SERIE 200	184
80340	FIAT	CROMA (Mod.2005)	77
	FIAT	CROMA (Mod.2005)	77
	OPEL	SIGNUM	77
	OPEL	VECTRA C	77
	SAAB	9-3 Sport (Mod.2007)	77
80341	LANDROVER	DEFENDER	493
	LANDROVER	DEFENDER	493
80342	OPEL	SIGNUM	76
	OPEL	VECTRA C	76
80343	mitsubishi	PAJERO II	246
80344	TOYOTA	PREVIA (ACR3_)	278
80345	TOYOTA	COROLLA VERSO (E12J)	276
80346	mitsubishi	SPACE WAGON (N3, N4)	246
80347	TOYOTA	CELICA (_T20_)	278
80348	TOYOTA	COROLLA VERSO (E12J)	276
80349	CITROEN	C3 Picasso	468
	PEUGEOT	207	468
80350	mitsubishi	L200	246
	mitsubishi	L200	246
80351	mitsubishi	GRANDIS	269
80352	mitsubishi	SPACE RUNNER (N6)	269
	mitsubishi	SPACE WAGON (N5)	269
80353	TOYOTA	PREVIA (ACR3_)	278
80354	FORD	TRANSIT - TOURNEO CONNECT	352
80355	TOYOTA	CELICA (_T20_)	278
80356	FORD	GALAXY (MOD. 2006)	369
	FORD	S-MAX	369



	Costruttore Car Manufacturers		N° Figura Drawing N°
80357	mitsubishi	COLT VI	147
	mitsubishi	COLT VII	147
	mitsubishi	COLT CZC	147
80358	SUZUKI	WAGON R+ (EM)	239
80359	TOYOTA	RAV 4 I (SXA1)	278
80360	mitsubishi	ECLIPSE I (D2 A)	246
	mitsubishi	GALANT III (E1 A )	246
	mitsubishi	GALANT IV (E3 A )	246
	mitsubishi	GALANT VI (EA )	246
	mitsubishi	SIGMA (F16A)	246
	mitsubishi	STARION	246
80361	FIAT COMM	SCUDO (Mod. 2007)	468
80362	TOYOTA	RAV 4 I (SXA1)	278
80363	mitsubishi	SPACE GEAR	249
80364	TOYOTA	COROLLA VERSO (_R1_)	372
80365	TOYOTA	AVENSIS (T25)	372
80366	mitsubishi	SPACE GEAR	249
80367	CHEVROLET / DAEWOO	AVEO	250
	CHEVROLET / DAEWOO	KALOS	250
80368	mitsubishi	SPACE GEAR	249
80369	mitsubishi	COLT IV	249
	mitsubishi	COLT V (CJ A)	249
	mitsubishi	LANCER V	249
	mitsubishi	LANCER VI	249
80370	mitsubishi	SPACE WAGON (DO W)	249
	BMW - MINI	Serie 5 (E39)	98
	BMW - MINI	Serie 7 (E38)	98
	BMW - MINI	Serie 8 (E31)	98
80371	HYUNDAI	ACCENT I	249
80372	mitsubishi	L 300 (P0_)	249
80373	CITROEN	C1	370
	CITROEN	107	370
	TOYOTA	AYGO	370
80374	mitsubishi	PAJERO II	249
80375	mitsubishi	L200	249
80376	SUBARU	FORESTER (SF)	336
80377	SUBARU	FORESTER (SF)	337
	SUBARU	FORESTER (SG)	337
80378	SUBARU	FORESTER (SF)	334
80379	SUBARU	IMPREZA (GD)	335
	SUBARU	LEGACY III (BE-BH)	335
	SUBARU	LEGACY III (BE-BH)	335
	SUBARU	LEGACY IV	335
	SUBARU	OUTBACK (BE-BH)	335
	SUBARU	OUTBACK (BE-BH)	335
80380	SUBARU	FORESTER (SF)	337
	SUBARU	FORESTER (SG)	337
80382	SUBARU	LEGACY III (BE-BH)	334
	SUBARU	LEGACY IV	334



	Costruttore Car Manufacturers		N° Figura Drawing N°
80382	SUBARU	OUTBACK (BE-BH)	334
	SUBARU	OUTBACK (BE-BH)	334
80383	SUBARU	IMPREZA (GD)	335
	SUBARU	LEGACY III (BE-BH)	335
	SUBARU	LEGACY III (BE-BH)	335
	SUBARU	LEGACY IV	335
	SUBARU	OUTBACK (BE-BH)	335
	SUBARU	OUTBACK (BE-BH)	335
	SUBARU	OUTBACK (BE-BH)	335
80384	OPEL COMM	MOVANO	457
	RENAULT comm	MASTER II-III	457
80385	OPEL COMM	MOVANO	457
	RENAULT comm	MASTER II-III	457
80386	HYUNDAI	TRAJET	148
80387	NISSAN	KING CAB (D21)	237
80388	FORD	C-MAX I	378
	FORD	C-MAX II	378
	FORD	FOCUS II	378
	FORD	FOCUS II (Restyling 2008->)	378
	FORD	KUGA	378
80389	MITSUBISHI	COLT V (CJ A)	251
	MITSUBISHI	LANCER VI	251
80390	HYUNDAI	COUPE II	148
	HYUNDAI	ELANTRA	148
80391	MITSUBISHI	COLT IV	251
	MITSUBISHI	LANCER V	251
80392	VW	PASSAT (3C2)	317
80393	HYUNDAI	TRAJET	148
80394	MITSUBISHI	PAJERO II	249
80395	HYUNDAI	COUPE I	253
	HYUNDAI	LANTRA II	253
80396	NISSAN	KING CAB (D21)	237
80397	LANDROVER	DEFENDER	493
80398	SUBARU	FORESTER (SF)	336
80399	TOYOTA	CELICA (ZZT23_)	281
80400	TOYOTA	PRIUS	281
80401	TOYOTA	CAMRY (V20)	280
80402	TOYOTA	CAMRY (V20)	280
80403	TOYOTA	CAMRY (V20)	282
80404	TOYOTA	CELICA (ZZT23_)	281
80405	TOYOTA	AVENSIS (T25)	373
	TOYOTA	COROLLA (E12)	373
	TOYOTA	COROLLA VERSO (_R1_)	373
80406	TOYOTA	AVENSIS (T25)	373
	TOYOTA	COROLLA (E12)	373
	TOYOTA	COROLLA VERSO (_R1_)	373
80407	TOYOTA	CELICA (_T20_)	281
80408	TOYOTA	CAMRY (V30)	280
80409	TOYOTA	PRIUS	281
80410	TOYOTA	CAMRY (V20)	282



	Costruttore Car Manufacturers		N° Figura Drawing N°
80411	MAZDA	DEMIO	319
80412	MAZDA	2	311
80413	TOYOTA	CAMRY (V30)	282
80414	MITSUBISHI	CARISMA	145
	MITSUBISHI	SPACE STAR	145
80415	AUDI	ALLROAD	50
80416	BMW - MINI	X3 (E83)	59
80429	CHRYSLER	VOYAGER I	387
80432	CHRYSLER	VOYAGER II	361
80435	CHEVROLET / DAEWOO	EVANDA	119
80436	CHEVROLET / DAEWOO	EVANDA	118
80437	CHEVROLET / DAEWOO	AVEO	388
	CHEVROLET / DAEWOO	KALOS	388
80438	CITROEN	C1	375
	CITROEN	107	375
	TOYOTA	AYGO	375
80439	CITROEN	C1	375
	CITROEN	107	375
	TOYOTA	AYGO	375
80440	CITROEN	BERLINGO (Mod.2008)	454
	CITROEN	C4 Picasso - Gran Picasso	454
	PEUGEOT	RANCH / PARTNER (Mod.2008)	454
80441	CITROEN	C4 Picasso - Gran Picasso	451
80442	MITSUBISHI	GALANT V (E5 A )	252
80443	DAIHATSU	CHARADE IV	389
80444	DAIHATSU	CHARADE IV	334
80445	DAIHATSU	CUORE (Mod.99)	287
	DAIHATSU	SIRION	287
	DAIHATSU	YRV	287
80447	DAIHATSU	TERIOS	390
80448	FIAT	DOBLO'	158
80449	FIAT	SEDICI	262
	SUZUKI	SX4	262
80450	FORD	GALAXY (MOD. 2006)	368
	FORD	MONDEO IV (03/07-)	368
	FORD	S-MAX	368
80455	HONDA	ACCORD IV	189
	HONDA	ACCORD VI	189
80456	HONDA	ACCORD IV	189
	HONDA	ACCORD VI	189
80457	HONDA	ACCORD VII	190
80458	HONDA	ACCORD VII	190
80459	HONDA	ACCORD VII	191
80460	HONDA	ACCORD VII	191
80461	HONDA	ACCORD VIII	168
80462	HONDA	ACCORD VIII	168
80463	HONDA	CRV I	187
	HONDA	CRV II	187
80464	HONDA	CRV I	187



	Costruttore Car Manufacturers		N° Figura Drawing N°
80464	HONDA	CRV II	187
80465	HONDA	HRV	187
80466	HONDA	PRELUDE IV	185
80467	HONDA	PRELUDE IV	185
80468	HONDA	PRELUDE IV	186
80469	HONDA	PRELUDE IV	186
80470	HONDA	PRELUDE V	187
80471	HONDA	PRELUDE V	187
80472	HONDA	PRELUDE V	186
80473	HONDA	PRELUDE V	186
80474	HONDA	SHUTTLE	184
80475	HONDA	SHUTTLE	184
80476	HYUNDAI	ACCENT I	253
80477	HYUNDAI	ACCENT I	253
80478	HYUNDAI	ACCENT II	148
80479	HYUNDAI	ACCENT II	148
80480	HYUNDAI	COUPE I	253
80480	HYUNDAI	LANTRA II	253
80481	HYUNDAI	COUPE I	253
	HYUNDAI	LANTRA II	253
80482	HYUNDAI	COUPE II	148
80483	HYUNDAI	COUPE II	148
80484	HYUNDAI	ELANTRA	148
80485	HYUNDAI	ELANTRA	148
80486	HYUNDAI	GALLOPER I-II	248
80487	HYUNDAI	GALLOPER I-II	248
80492	HYUNDAI	GETZ	267
80493	HYUNDAI	GETZ	271
80494	HYUNDAI	GETZ	271
80495	HYUNDAI	LANTRA II	253
80496	HYUNDAI	MATRIX	148
80497	HYUNDAI	MATRIX	148
80501	HYUNDAI	SANTA FE' I	272
80502	HYUNDAI	SONATA II	253
80503	HYUNDAI	SONATA II	253
80504	HYUNDAI	SONATA II	245
80505	HYUNDAI	SONATA II	268
	HYUNDAI	SONATA III	268
80506	HYUNDAI	SONATA III	150
80507	HYUNDAI	SONATA III	150
80508	HYUNDAI	SONATA IV	268
	HYUNDAI	SONATA IV	268
80509	HYUNDAI	SONATA IV	267
80510	HYUNDAI	TERRACAN	148
80511	HYUNDAI	TERRACAN	148
80512	HYUNDAI	TERRACAN	148
80513	HYUNDAI	TERRACAN	148
80514	HYUNDAI	TERRACAN	151
80515	HYUNDAI	TRAJET	267



	Costruttore Car Manufacturers		N° Figura Drawing N°
80516	HYUNDAI	TRAJET	267
80517	HYUNDAI	TRAJET	150
80520	HYUNDAI	TUCSON	148
80521	HYUNDAI	TUCSON	148
80522	HYUNDAI	H1	155
80523	HYUNDAI	H1	152
80524	HYUNDAI	H1	267
80525	HYUNDAI	H1	267
80526	HYUNDAI	H100	245
80527	HYUNDAI	H100	247
80528	HYUNDAI	H100	245
80529	KIA	CARNIVAL I	332
	KIA	CARNIVAL II	332
80530	KIA	CARNIVAL I	327
	KIA	CARNIVAL II	327
80531	KIA	CARNIVAL I	319
	KIA	CARNIVAL II	319
80532	KIA	CLAURUS I-II	347
80537	LANDROVER	DISCOVERY	165
	LANDROVER	RANGE ROVER II	165
80538	LANDROVER	FREELANDER I	188
80539	MAZDA	3	207
80544	VW	TOUAREG	66
80545	MAZDA	323 S	324
80546	MAZDA	323 S	319
80547	MAZDA	DEMIO	326
80548	MAZDA	DEMIO	319
80549	MAZDA	MPV I	322
80550	MAZDA	MPV I	320
80551	MAZDA	MPV I	328
80552	MAZDA	MPV I	330
80553	MAZDA	MPV II	322
80554	MAZDA	MPV II	319
80555	MAZDA	MPV II	331
80556	MAZDA	MPV II	329
80557	MAZDA	MX3	233
80558	MCC (SMART)	City Coupe' (MC01)	159
80561	MITSUBISHI	CARISMA	154
80562	MITSUBISHI	CARISMA	154
	MITSUBISHI	SPACE STAR	154
80563	MITSUBISHI	COLT VI	470
	MITSUBISHI	COLT VII	470
	MITSUBISHI	COLT CZC	470
80564	MITSUBISHI	GRANDIS	153
80565	MITSUBISHI	GRANDIS	145
80566	MITSUBISHI	L 300 (P0_)	200
80567	MITSUBISHI	SPACE GEAR	249
80568	MITSUBISHI	SPACE RUNNER (N6)	147
	MITSUBISHI	SPACE WAGON (N5)	147



	Costruttore Car Manufacturers		N° Figura Drawing N°
80569	MITSUBISHI	SPACE RUNNER (N6)	145
	MITSUBISHI	SPACE WAGON (N5)	145
80570	NISSAN	ALMERA TINO	95
80571	NISSAN	ALMERA TINO	300
80572	NISSAN	ALMERA TINO	214
80573	NISSAN	MICRA (K12)	96
	NISSAN	NOTE	96
80574	NISSAN	MICRA (K12)	303
	NISSAN	NOTE	303
80575	NISSAN	MICRA (K12)	294
	NISSAN	NOTE	294
80576	NISSAN	PRIMERA (P10)	302
80577	NISSAN	PRIMERA (P10)	301
80578	NISSAN	PRIMERA (W10)	229
80579	NISSAN	PRIMERA (W10)	230
80584	OPEL	MERIVA	79
80587	NISSAN comm	INTERSTAR	459
	OPEL COMM	MOVANO	459
	RENAULT comm	MASTER II-III	459
80588	NISSAN comm	INTERSTAR	458
	OPEL COMM	MOVANO	458
	RENAULT comm	MASTER II-III	458
80589	MITSUBISHI	GALANT V (E5 A )	245
80590	PORSCHE	924	105
	PORSCHE	944	105
80591	PORSCHE	924	104
	PORSCHE	944	104
80592	PORSCHE	911 (996)	61
	PORSCHE	911 (996)	61
	PORSCHE	911 (997)	61
	PORSCHE	911 (997)	61
	PORSCHE	BOXSTER (986)	61
	PORSCHE	BOXSTER (986)	61
	PORSCHE	BOXSTER	61
	PORSCHE	BOXSTER	61
	PORSCHE	BOXSTER	61
80593	MITSUBISHI	GALANT V (E5 A )	246
80594	VW	TOUAREG	71
80595	ROVER	75	385
80596	ROVER	75	386
80597	SAAB	900	110
	SAAB	9-3 (YS3D)	110
	SAAB	9-3 (YS3F)	110
80598	SAAB	9-5	112
80599	SAAB	9-5	73
80600	SUBARU	LEGACY III (BE-BH)	334
80601	SUZUKI	GRAND VITARA (FT-GT)	20
80602	SUZUKI	GRAND VITARA (FT-GT)	19
80603	SUZUKI	SPLASH	263
	SUZUKI	SWIFT III	263



	Costruttore Car Manufacturers		N° Figura Drawing N°
80604	SUZUKI	SPLASH	254
	SUZUKI	SWIFT III	254
80605	SUZUKI	SPLASH	254
	SUZUKI	SWIFT III	254
80606	MITSUBISHI	GALANT VI (EA )	252
80607	TOYOTA	4 RUNNER (N130)	384
	TOYOTA	4 RUNNER	384
80608	TOYOTA	CAMRY (V30)	281
80609	TOYOTA	CAMRY (V30)	281
80610	TOYOTA	CELICA (ZZT23_)	287
80611	TOYOTA	COROLLA (E12)	374
80612	TOYOTA	LAND CRUISER (J8_)	143
	TOYOTA	LAND CRUISER (J9_)	143
80613	TOYOTA	LAND CRUISER (J8_)	142
	TOYOTA	LAND CRUISER (J9_)	142
80614	TOYOTA	LAND CRUISER 100 (J10_)	285
80615	TOYOTA	LAND CRUISER 100 (J10_)	285
80616	TOYOTA	LAND CRUISER 100 (J10_)	286
80617	TOYOTA	LAND CRUISER 100 (J10_)	283
80618	TOYOTA	PASEO	284
	TOYOTA	STARLET (EP91)	284
80619	TOYOTA	PASEO	284
	TOYOTA	STARLET (EP91)	284
80620	TOYOTA	AVENSIS VERSO	384
	TOYOTA	PREVIA (ACR3_)	384
80621	TOYOTA	PRIUS	287
80624	VW	LUPO	70
80625	VW	LT I	481
	VW	LT I	481
80626	VOLVO	S40 I	154
	VOLVO	V40	154
80627	HONDA	ACCORD VIII	170
80628	HONDA	ACCORD VIII	170
80629	HYUNDAI	SONATA IV	150
80630	HYUNDAI	SONATA IV	150
80631	HONDA	LOGO	187
80632	HONDA	LOGO	187
80633	BMW - MINI	MINI (R50-R52-R53)	83
80634	BMW - MINI	MINI (R50-R52-R53)	84
80635	BMW - MINI	MINI (R56-R57)	59
	BMW - MINI	MINI Clubman (R55)	59
80636	NISSAN	TRADE	393
80638	NISSAN	TRADE	108
80639	MAZDA	3	210
	MAZDA	5	210
80640	KIA	PICANTO	148
80641	KIA	PICANTO	145
80642	KIA	PICANTO	400
80643	KIA	PICANTO	403



	Costruttore Car Manufacturers		N° Figura Drawing N°
80644	FIAT	CROMA (Mod.2005)	73
	FIAT	CROMA (Mod.2005)	73
80645	TOYOTA	RAV 4 II (XA2)	292
80646	TOYOTA	RAV 4 II (XA2)	289
80647	TOYOTA	RAV 4 II (XA2)	293
80648	TOYOTA	RAV 4 II (XA2)	291
80649	TOYOTA	RAV 4 II (XA2)	395
80650	TOYOTA	RAV 4 III	435
80651	TOYOTA	RAV 4 III	435
80652	TOYOTA	RAV 4 III	436
80653	TOYOTA	RAV 4 III	437
80654	AUDI	Q5	64
80655	AUDI	A4 (Mod.2008)	64
	AUDI	A5	64
	AUDI	Q5	64
80656	BMW - MINI	X1 (E84)	59
80657	BMW - MINI	X5 (E70)	59
	BMW - MINI	X6 (E71)	59
80658	BMW - MINI	X5 (E70)	59
	BMW - MINI	X6 (E71)	59
80659	CHEVROLET / DAEWOO	CAPTIVA	429
	OPEL	ANTARA	429
80660	CHEVROLET / DAEWOO	CAPTIVA	429
	OPEL	ANTARA	429
80661	CHEVROLET / DAEWOO	CAPTIVA	430
	OPEL	ANTARA	430
80662	CHEVROLET / DAEWOO	CAPTIVA	430
	OPEL	ANTARA	430
80663	CITROEN	C-Crosser	405
	MITSUBISHI	OUTLANDER II	405
	PEUGEOT	4007	405
80664	CITROEN	C-Crosser	405
	MITSUBISHI	OUTLANDER II	405
	PEUGEOT	4007	405
80665	CITROEN	C-Crosser	269
	MITSUBISHI	OUTLANDER II	269
	PEUGEOT	4007	269
80666	DACIA	DUSTER	454
80667	HONDA	CRV III	182
80668	HONDA	CRV III	182
80669	HONDA	CRV III	176
80670	HYUNDAI	SANTA FE' II	35
	KIA	SORENTO III	35
80671	HYUNDAI	SANTA FE' II	33
	KIA	SORENTO III	33
80672	HYUNDAI	SANTA FE' II	27
	KIA	SORENTO III	27
80673	HYUNDAI	SANTA FE' II	31
	KIA	SORENTO III	31

	Costruttore Car Manufacturers		N° Figura Drawing N°
80674	KIA	SORENTO II	30
80675	KIA	SORENTO II	30
80676	KIA	SORENTO I	34
80677	KIA	SORENTO I	34
80678	LANDROVER	FREELANDER I	184
80680	LANDROVER	FREELANDER I	183
80681	MITSUBISHI	PAJERO III	404
80682	MITSUBISHI	PAJERO III	399
80685	NISSAN	PATHFINDER (R51)	420
80686	NISSAN	PATHFINDER (R51)	420
80687	NISSAN	X-TRAIL II (T31)	421
	RENAULT	KOLEOS	421
80688	NISSAN	X-TRAIL II (T31)	391
	RENAULT	KOLEOS	391
80689	NISSAN	X-TRAIL II (T31)	424
	RENAULT	KOLEOS	424
80690	NISSAN	X-TRAIL II (T31)	231
	RENAULT	KOLEOS	231
80691	SUZUKI	GRAND VITARA (JT)	266
80692	SUZUKI	GRAND VITARA (JT)	256
80693	SUZUKI	GRAND VITARA (JT)	264
80694	SUZUKI	GRAND VITARA (JT)	265
80695	SUZUKI	JIMNY	14
80696	SUZUKI	JIMNY	259
80697	LANDROVER	FREELANDER 2	367
80698	LANDROVER	FREELANDER 2	368
80699	TOYOTA	LAND CRUISER (J12_)	395
80700	TOYOTA	LAND CRUISER (J12_)	286
80701	TOYOTA	LAND CRUISER 150 (J15_)	434
80706	TOYOTA	LAND CRUISER (J20_)	435
80708	VOLVO	XC60	368
80709	VOLVO	S60 II	417
	VOLVO	V60	417
	VOLVO	XC60	417
80710	VOLVO	S60 II	418
	VOLVO	V60	418
	VOLVO	XC60	418
80711	VOLVO	S80	43
	VOLVO	XC70 I	43
80712	VOLVO	XC70 I	42
80713	VOLVO	S80 II	368
	VOLVO	V70 III	368
	VOLVO	XC70 II	368
80715	VOLVO	S80 II	416
	VOLVO	V70 III	416
	VOLVO	XC70 II	416
80716	VOLVO	XC90	43
80717	VOLVO	XC90	42
80718	ALFA ROMEO	GIULIETTA (Mod.2010)	158



	Costruttore Car Manufacturers		N° Figura Drawing N°
80718	ALFA ROMEO	MITO	158
80719	ALFA ROMEO	GIULIETTA (Mod.2010)	158
80720	FIAT	500L (09/2012->)	158
	FIAT	PUNTO Evo	158
	FIAT	Punto MY2012	158
80721	AUDI	A4 (Mod.2008)	64
	AUDI	A5	64
80722	AUDI	TT (Mod 2007)	317
80723	AUDI	TT (Mod 2007)	316
80724	AUDI	TT (Mod 2007)	316
80725	BMW - MINI	MINI (R56-R57)	58
	BMW - MINI	MINI Clubman (R55)	58
80726	BMW - MINI	Z4	58
80729	BMW - MINI	Z4	59
80730	CHEVROLET / DAEWOO	SPARK	256
80731	CHEVROLET / DAEWOO	SPARK	254
80735	CHRYSLER	VOYAGER IV	364
80736	CHRYSLER	VOYAGER IV	363
80741	CITROEN	C3 (Mod.2009) - DS3	454
	PEUGEOT	208	454
80744	CITROEN	C3 (Mod.2009) - DS3	471
80745	CITROEN	NEMO	158
	PEUGEOT	BIPPER	158
80746	RENAULT	KANGOO (Mod.2008)	454
80747	RENAULT	ESPACE III	453
	RENAULT	KANGOO (Mod.2008)	453
	RENAULT	MEGANE II	453
	RENAULT	TWINGO	453
80748	CITROEN COMM	JUMPY (Mod. 2007)	473
	PEUGEOT	EXPERT (Mod. 2007)	473
80749	CITROEN COMM	JUMPY (Mod. 2007)	471
	PEUGEOT	EXPERT (Mod. 2007)	471
80750	FORD	C-MAX II	207
	FORD	FOCUS II (Restyling 2008->)	207
80751	FORD	FIESTA VI (10/08-)	315
80752	FORD	FIESTA VI (10/08-)	311
80755	FORD	KA (Mod.2009)	158
80758	FORD	KA (Mod.2009)	156
80760	FORD	GALAXY (MOD. 2006)	369
	FORD	MONDEO IV (03/07-)	369
	FORD	S-MAX	369
80761	FORD	KUGA	207
80762	HONDA	ACCORD IX	173
80763	HONDA	ACCORD IX	173
80764	HONDA	ACCORD IX	180
80765	HONDA	ACCORD IX	181
80766	HONDA	FRV	175
80767	HONDA	FRV	177
80768	HONDA	FRV	176



	Costruttore Car Manufacturers		N° Figura Drawing N°
80769	HONDA	FRV	174
80770	HYUNDAI	ACCENT III	24
80771	HYUNDAI	ACCENT III	22
80772	HYUNDAI	ACCENT III	402
	KIA	RIO II	402
80773	HYUNDAI	ACCENT III	402
	KIA	RIO II	402
80774	HYUNDAI	H1 (Mod.2008)	32
80775	HYUNDAI	H1 (Mod.2008)	32
80776	HYUNDAI	H1 (Mod.2008)	29
80777	HYUNDAI	H1 (Mod.2008)	26
80778	KIA	CARENS III	401
80779	KIA	CARENS III	401
80780	KIA	CARENS III	410
80781	KIA	CARENS III	411
80782	KIA	CEE'D - PRO CEE'D	398
80783	KIA	CEE'D - PRO CEE'D	398
80784	KIA	CEE'D - PRO CEE'D	397
80785	KIA	CEE'D - PRO CEE'D	397
80787	KIA	RIO	348
80788	KIA	RIO II	23
80789	KIA	RIO II	21
80791	KIA	SOUL	412
80792	KIA	SOUL	413
80793	KIA	SOUL	413
80794	KIA	VENGA	415
80806	MERCEDES	CLASSE C (W204)	63
	MERCEDES	CLASSE GLK (X204)	63
80807	MERCEDES	CLASSE E (W212)	62
80808	MERCEDES	CLASSE E (W212)	62
80809	MERCEDES	CLASSE GLK (X204)	62
80811	MITSUBISHI	COLT VI	469
	MITSUBISHI	COLT VII	469
	MITSUBISHI	COLT CZC	469
80815	NISSAN	CUBE (Z12)	421
80816	NISSAN	CUBE (Z12)	365
80817	NISSAN	CUBE (Z12)	424
80818	NISSAN	CUBE (Z12)	425
80819	NISSAN	QASHQAI	304
80820	NISSAN	QASHQAI	97
80821	NISSAN	QASHQAI	305
80822	NISSAN	QASHQAI	306
80823	NISSAN	PIXO (UA0)	266
80824	NISSAN	PIXO (UA0)	266
80825	NISSAN	PIXO (UA0)	254
80826	OPEL	AGILA (Mod. 2007)	258
80827	OPEL	AGILA (Mod. 2007)	254
80828	OPEL	AGILA (Mod. 2007)	254
80829	OPEL	INSIGNIA	80

	Costruttore Car Manufacturers		N° Figura Drawing N°
80830	OPEL	INSIGNIA	86
80831	OPEL	INSIGNIA	80
80832	CHEVROLET / DAEWOO	CRUZE	85
	OPEL	ASTRA J	85
80835	PEUGEOT	308	454
	PEUGEOT	3008	454
	PEUGEOT	5008	454
80840	PEUGEOT	607	463
80841	PEUGEOT	607	462
80842	CITROEN	NEMO	156
	PEUGEOT	BIPPER	156
80843	RENAULT	LAGUNA III	472
80846	RENAULT	MEGANE III	454
	RENAULT	SCENIC III	454
80849	SAAB	9-3 Sport (Mod.2007)	78
80850	SAAB	9-3 Sport (Mod.2007)	78
80851	SEAT	IBIZA V (6J5)	317
	VW	Polo V (6R) (06/09->)	317
80852	SEAT	LEON II (1P1)	317
	SKODA	OCTAVIA II (1Z3-1Z5)	317
	SKODA	SUPERB II (3T4)	317
	SKODA	YETI	317
	VW	EOS	317
	VW	GOLF VI	317
	VW	JETTA III	317
	VW	SCIROCCO (137)	317
	VW	TOURAN	317
80854	MCC (SMART)	Fortwo Coupé (Mod.2007)	158
80858	SUBARU	LEGACY V	339
80859	SUBARU	LEGACY V	339
80860	SUBARU	LEGACY V	343
80861	SUBARU	LEGACY V	344
80865	SUBARU	FORESTER (SH)	357
80866	SUBARU	FORESTER (SH)	357
80867	SUBARU	FORESTER (SH)	341
80868	SUBARU	FORESTER (SH)	341
80869	SUBARU	TRIBECA	338
80870	SUBARU	TRIBECA	338
80871	SUBARU	TRIBECA	340
80872	SUBARU	TRIBECA	342
80874	SUZUKI	ALTO V (GF)	256
80875	SUZUKI	ALTO V (GF)	256
80876	SUZUKI	ALTO V (GF)	254
80878	TOYOTA	AURIS	375
80879	TOYOTA	AURIS	375
80880	TOYOTA	AURIS	376
	TOYOTA	VERSO	376
80881	TOYOTA	VERSO	371
80882	TOYOTA	VERSO	370

	Costruttore Car Manufacturers		N° Figura Drawing N°
80883	TOYOTA	AVENSIS (T27)	375
80884	TOYOTA	AVENSIS (T27)	375
80885	TOYOTA	AVENSIS (T27)	377
80886	TOYOTA	PRIUS (Mod.2009)	435
80887	TOYOTA	PRIUS (Mod.2009)	435
80891	TOYOTA	URBAN CRUISER	396
	TOYOTA	VERSO S	396
	TOYOTA	YARIS II	396
80892	SKODA	YETI	316
	VW	EOS	316
	VW	SCIROCCO (137)	316
80893	VW	TIGUAN	317
80894	VW	PASSAT (362, 365)	146
	VW	SHARAN (Mod. 2010)	146
	VW	TIGUAN	146
80895	VW	MULTIVAN	65
	VW	TRANSPORTER T5	65
80896	VW	MULTIVAN	61
	VW	TRANSPORTER T5	61
80897	VOLVO	C30	82
	VOLVO	S40 II	82
	VOLVO	V50	82
80898	VOLVO	C30	207
	VOLVO	S40 II	207
	VOLVO	V50	207
	VOLVO	V50	207
80899	VOLVO	S60 II	368
	VOLVO	S80 II	368
	VOLVO	V60	368
	VOLVO	V70 III	368
	VOLVO	XC70 II	368
80902	HYUNDAI	I10	149
80903	HYUNDAI	I10	401
80904	HYUNDAI	I10	401
80905	HYUNDAI	I20	406
80906	HYUNDAI	I20	409
80909	HYUNDAI	I30	398
80910	HYUNDAI	I30	398
80911	HYUNDAI	I30	431
80912	HYUNDAI	I30	431
80913	HYUNDAI	IX35	407
	KIA	SPORTAGE III	407
80914	HYUNDAI	IX35	408
	KIA	SPORTAGE III	408
80915	HYUNDAI	IX35	433
	KIA	SPORTAGE III	433
80916	HYUNDAI	IX35	432
	KIA	SPORTAGE III	432
80917	KIA	SORENTO I	30
80918	KIA	SORENTO I	30



	Costruttore Car Manufacturers		N° Figura Drawing N°
80919	KIA	SORENTO II	427
80924	MITSUBISHI	LANCER VII	404
	MITSUBISHI	OUTLANDER I	404
80925	MITSUBISHI	LANCER VII	269
	MITSUBISHI	OUTLANDER I	269
80926	NISSAN	NAVARA (D40)	419
80927	NISSAN	X-TRAIL I (T30)	421
80928	NISSAN	X-TRAIL I (T30)	423
80929	NISSAN	X-TRAIL I (T30)	424
80930	NISSAN	X-TRAIL I (T30)	425
80931	NISSAN	JUKE	422
80932	NISSAN	JUKE	93
80933	NISSAN	JUKE	424
80934	NISSAN	JUKE	425
80935	NISSAN	MICRA (K13)	426
80936	NISSAN	MICRA (K13)	392
80937	NISSAN	MICRA (K13)	419
80938	RENAULT	MEGANE III	453
80938	RENAULT	SCENIC III	453
80939	SUZUKI	JIMNY	254
80942	TOYOTA	YARIS II (Made in France)	353
80943	TOYOTA	YARIS II (Made in France)	353
80944	TOYOTA	YARIS II (Made in France)	354
80946	VOLVO	S80 II	368
	VOLVO	V70 III	368
	VOLVO	XC70 II	368
80947	VOLVO	C30	81
	VOLVO	S40 II	81
	VOLVO	V50	81
	VOLVO	V50	81
80948	AUDI	A1	317
	SEAT	IBIZA V (6J5)	317
	VW	Polo V (6R) (06/09->)	317
80949	BMW - MINI	Serie 7 (E65,E66)	59
80950	BMW - MINI	X3 (F25)	67
80951	BMW - MINI	X3 (F25)	58
80954	DAIHATSU	CUORE (Mod. 2003)	358
	DAIHATSU	TREVIS	358
80955	DAIHATSU	CUORE (Mod. 2003)	355
	DAIHATSU	TREVIS	355
80956	DAIHATSU	CUORE (Mod. 2007)	360
80957	DAIHATSU	CUORE (Mod. 2007)	359
80958	DAIHATSU	CUORE (Mod. 2007)	355
80959	DAIHATSU	TERIOS II	389
80960	DAIHATSU	TERIOS II	389
80961	DAIHATSU	TERIOS II	356
80962	DAIHATSU	TERIOS II	355
80963	FIAT	DOBLO' (Mod.2010)	158
80964	FIAT	DOBLO' (Mod.2010)	156
80965	FORD	TRANSIT (2006->)	366

	Costruttore Car Manufacturers		N° Figura Drawing N°
80966	FORD	TRANSIT (2006->)	206
80967	FORD	TRANSIT (2006->)	206
80968	HONDA	CIVIC VI	172
80969	HONDA	CIVIC VI	172
80970	HONDA	CIVIC VI	169
80971	HONDA	CIVIC VI	169
80972	HONDA	CIVIC VII	445
80973	HONDA	CIVIC VII	446
80974	HONDA	CIVIC VII	167
80975	HONDA	CIVIC VII	166
80976	HONDA	JAZZ (Mod. 2002)	443
80977	HONDA	JAZZ (Mod. 2002)	444
80978	HONDA	JAZZ (Mod. 2002)	165
80979	HONDA	JAZZ (Mod. 2002)	165
80984	KIA	CERATO	397
80985	FIAT	YPSILON (MOD. 2011)	156
80986	LANDROVER	DISCOVERY II	179
80987	LANDROVER	DISCOVERY II	179
80988	LANDROVER	DISCOVERY II	179
80989	LANDROVER	DISCOVERY II	179
80992	LANDROVER	DISCOVERY III	171
	LANDROVER	DISCOVERY IV	171
80993	LANDROVER	RANGE ROVER II	178
80994	LANDROVER	RANGE ROVER III	59
80997	LANDROVER	RANGE ROVER SPORT	165
80998	MERCEDES	CLASSE M (W164)	63
80999	MERCEDES	CLASSE M (W164)	63
81000	MERCEDES	CLASSE S (W221)	62
81001	MERCEDES	CLASSE S (W221)	62
81004	RENAULT comm	MASTER IV	454
81005	RENAULT comm	MASTER IV	454
81006	TOYOTA	AVENSIS VERSO	284
81007	TOYOTA	IQ	435
81008	TOYOTA	IQ	435
81009	TOYOTA	IQ	434
81011	VW	PASSAT (362, 365)	317
81012	AUDI	A8 (Mod 2002)	243
	VW	PHAETON	243
81013	VW	PHAETON	242
81014	VW	SHARAN (Mod. 2010)	317
81015	FIAT	FREEMONT	382
81016	FIAT	FREEMONT	382
81017	FIAT	FREEMONT	428
81018	FIAT	FREEMONT	383
81019	FIAT	FREEMONT	381
81020	AUDI	A3 (Mod. 2003)	316
	SEAT	ALTEA	316
	SEAT	ALTEA	316
	SEAT	LEON II (1P1)	316







# Tubi flessibili per Freno e Frizione

Catalogo

01  
13

Tabella comparativa



# TABELLA COMPARATIVA

Alfa Romeo	Akron	Alfa Romeo	Akron	Alfa Romeo	Akron	Audi - VW Seat - Skoda	Akron
0060501721	8378	60536813	8421	71736923	8552	1K0611701	80160
101336	8289	60536905	8370	71736929	8378	1K0611701B	80160
101341	8290	60537428	8420	71736929	8422	1K0611701C	81020
105144554400	8024	60540018	8436	71736931	8492	1K0611701K	80160
105144554500	8025	60546644	8434	71736934	8151	1K0611701L	81020
105411289800	8151	60546646	8435	71736935	8376	1K0611701M	80160
105484554401	8024	60552450	8290	71736937	8492	1K0611775	80161
105484554402	8024	60556927	8439	71736939	8493	1K0611775A	80161
107101	8289	60556929	8440	71736944	8439	1K0611775B	80161
107102	8290	60557031	8438	71736950	8489	1K0611775C	80161
116014554400	8283	60557031	8439	71736960	8459	1K0611775D	80852
116014554402	8283	60559895	8419	71736972	8025	1L0611701	8644
116014554500	8284	60562631	8566	7667806	8417	1Q0611775A	80892
116334554400	8283	60564765	8434	795023	8517	1S0611701	81058
116334554401	8283	60564766	8492	82409618	8399	1S0611775	81059
116464554300	8376	60570999	8442	<b>Audi - VW Seat - Skoda</b>	<b>Akron</b>	1T0611775A	80161
116551802000	8151	60588022	8493	005312587	8991	211611701B	8240
116584554400	8376	60594015	8491	005312593	8010	211611775	8049
116584554501	8377	60602274	8490	113611701B	8208	211611775A	8241
164003208701	8434	60603030	8491	113611701E	8238	211611775B	8240
164003254500	8435	60606168	8977	113611701E	8238	211611775C	8049
164004354400	8434	60608470	8438	113611775	8240	251611775B	8256
46448592	8553	60614861	8978	113611775BD	8241	281611771	80625
46454474	8568	60618617	8980	113611775E	8239	281611771C	80240
46474539	8567	60622814	8440	114595611	8009	281611775	8036
46534942	8976	60622815	8439	114595613	8008	281611775B	80255
50518954	80719	60651553	8901	115595612	8010	291611775	8256
51811926	80718	60651554	8900	115595620	8406	2D0611701	8931
542371	8378	60651567	8902	115595621	8333	2D0611701B	8931
542420	8421	60652184	8979	171611701	8247	2D0611711B	8931
542897	8370	60658944	8975	171611701B	8234	2D0611775A	80249
543793	8370	60698794	80185	171611701D	8248	2E0611707A	80245
545063	8234	60698796	80189	171611701G	8228	2E0611807B	80245
545379	8370	60709427	8289	171611701G	8030	2H0611701	81064
546442	8378	60709428	8290	171611701G	8228	2H0611775	81065
546648	8423	60714552	8024	171611701K	8249	2K0611775C	80162
547010	8422	60714553	8025	171611701L	8228	321611701B	8235
549114	8421	60718544	8289	171611775	8229	321611701B	8228
549791	8378	60718545	8290	171611775A	8229	321611701C	8249
55700975	80186	60724771	8283	175611701A	8228	321611701D	8249
60501245	8441	60724772	8284	175611775	8229	321611775	8207
60501717	8423	60727319	8283	191611701	8228	321611775	80241
60501721	8422	60728511	8376	191611701A	80247	321611775B	80241
60501724	8422	60747207	8234	1H0611701	8551	3AA611701A	81011
60501727	8421	60747322	8370	1H0611775	8643	3C0611701H	80392
60502667	8378	60747528	8420	1H06117775	8643	3C0611775C	80161
60507992	8434	60747830	8420	1J0611701	8616	3D0611701E	81012
60508002	8492	60750508	8517	1J0611701L	8616	3D0611775G	81013
60511538	8438	60751672	8151	1J0611701M	81071	4105804	8266
60511713	8492	60800372	8459	1J0611704L	8616	4257052	8269
60516716	8151	60806216	8489	1J0611763K	80622	4270732	8266
60522444	8151	60808815	8489	1J0611764K	80623	431611707	8232
60522545	8376	60812130	8553	1J0611775	8903	431611775A	8227
60522547	8377	60812250	8552	1J1721465M	8990	431611775B	8242

# TABELLA COMPARATIVA

Catalogo  
0113

Audi - VW Seat - Skoda	Akron	Audi - VW Seat - Skoda	Akron	Audi - VW Seat - Skoda	Akron	Audi - VW Seat - Skoda	Akron
433611707	8233	6N0611701/AB	8966	7M3611701C	80258	8Z0611707	80172
433611755A	8227	6N0611701A	8966	7N0611701	81014	8Z0611707C	80172
433611775A	8227	6N0611701AB	8966	801611707C	8226	8Z0611775B	80173
433611775A	8039	6N0611701B	8966	803611775	8230	9014280835	80245
433611775A	8227	6N0611775	8967	810611707	80240	9014289135	80235
4348052	8266	6N0611775A	8967	810611707	8231	9044280535	80242
437611775	8036	6Q0611701C	80008	811611775	8230	J9094702383	80145
443611707	8233	6Q0611701E	80008	811611775A	8041	SE021744400A	8513
443611775A	8254	6Q0611775A	8903	823611707	8235	SE022744400A	8512
443611775C	8233	6Q0611775B	8903	823611707	8228	SE022744400B	8510
443611775D	8227	6Q1611701C	80008	84911707A	8228	SE022744400C	8355
443611775F	8039	6R0611701A	80851	849611707A	8452	SE028744400A	8642
481611766	8230	6R0611701B	80948	849611707A	8228	SE141744400B	8353
481611775	8036	6U0611701	8010	861611707B	8226	SE141744400D	8354
481611776	8229	6U0611701A	80256	861611707C	8226		
4A0611707	8030	6U0611701B	80256	861611775	8236	<b>Bedford</b>	<b>Akron</b>
4A0611775	8043	6U0611707	8991	861611775	80241	562304	8226
4A0611775B	8906	6U0611775	8991	893611707	8035	90010524	8540
4B0611775	8043	6U0611775A	8991	893611775A	8036	90121718	8223
4B0611775	8905	6X0611775	8903	8A0611775	8038	91071939	80307
4B0611775A	80248	6X0611775A	8903	8A0611775A	80331	94113583	8697
4B0611775B	80248	6X0611775B	8903	8A0611775D	8037	97134830	8617
4B0611775C	80248	701611701	8057	8D0611707	8035		
4D0611707D	80163	7D0611701B	8974	8D0611707B	8035	<b>Bmw - Mini</b>	<b>Akron</b>
4D0611707F	80163	7D0611701C	8972	8D0611707D	8035	34106779817	80633
4D0611707H	80163	7D0611701E	8972	8D0611775B	8062	34116772555	80725
4D0611775A	80317	7D0611702	8971	8D0611775E	8061	34206784620	80726
4D0611775B	80317	7D0611775C	8229	8D0611775F	8038	34226760909	80281
4E0611775F	8061	7H0611701B	80167	8D0611775J	8904	34301163080	80331
4F0611707	80164	7H0611701D	80895	8D1721465	8989	34301163155	80336
4F0611707B	80164	7H0611775	80168	8E0611707	80171	34301165074	8909
4F0611775	80165	7H0611775B	80896	8E0611707A	80171	34301165075	8913
4F0611775D	80165	7H0611776	80228	8E0611707D	80171	34301165174	8909
4G0611707E	81023	7H0611776B	80228	8E0611707G	80171	34301165190	8912
4G0611775C	81024	7H0611776C	81022	8E0611775	8038	34301165249	8911
4Z7611707A	80415	7L0611701A	80169	8E0611775B	8968	34301165765	80418
535611701	8550	7L0611701C	80169	8E0611775C	80248	34301165766	80417
561611701	81068	7L0611776	80170	8E0611775H	80254	34301166118	80294
561611775	81069	7L0611776A	80170	8E0611775HN	80254	34301166248	8913
561611776	81069	7L0614161B	80544	8E0611775J	8968	34303411443	80305
5959715	8353	7L6611701A	80544	8E0611775N	80254	34303411444	80416
5N0611701	80893	7L6611701AB	80544	8J0611701C	80722	34306760221	80634
5N0611701A	81025	7L6611701B	80544	8J0611701D	80723	34306762185	80729
5N0611775	80894	7L6611776	80707	8J0611775B	80724	34306762837	80330
5N0611775A	81026	7L6611776 A	80594	8K0611707A	80721	34306762838	80232
5Q0611701C	81066	7L6611776A	80594	8K0611707B	80721	34306767458	80264
5Q0611775J	81067	7M0611701D	8924	8K0611707C	80721	34306768851	80330
634259300	8010	7M0611775E	80244	8K0611707D	80721	34306771720	80266
6E0611701A	80624	7M0611776B	8925	8K0611707E	80721	34306774341	80727
6E0611701B	80166	7M0611776B/C	8925	8K0611775F	80655	34306774342	80728
6E0611701C	80624	7M0611776BC	8925	8K0611775J	80655	34306776293	80658
6K0611701	8551	7M0611776C	8925	8N0611707A	80275	34306778260	80657
6K9611776	8969	7M3611701A	80258	8R0611707A	80654	34306781667	80635
6N0611701	8966	7M3611701B	80258	8R0611707B	80654	34306787316	80656

# TABELLA COMPARATIVA

<b>Bmw - Mini</b>	<b>Akron</b>	<b>Bmw - Mini</b>	<b>Akron</b>	<b>Chrysler</b>	<b>Akron</b>	<b>Citroen Peugeot</b>	<b>Akron</b>
34306787512	80950	34326766968	80728	4683790AC	80921	480658	8939
34306788436	80657	34326767390	80281	4683791AC	80920	480661	8518
34306788437	80658	34326775259	81029	4721038	80433	480662	8625
34306788442	80725	34326775261	81028	4721039	80434	480663	8627
34306788443	80635			4721324AA	80923	480664	8626
34306789431	80330	<b>Chevrolet</b>	<b>Akron</b>	4721325AA	80922	480665	8548
34306789433	80232	<b>Daewoo</b>		4797620AC	80430	480667	8573
34306792253	80330	12774865	80832	4797621	80431	480668	8570
34306792254	81027	13254605	80733	4860068AC	80423	480670	8571
34306797527	80951	13254606	80734	4860069AB	80424	480671	8571
34309804831	81030	13320679	80733	4860080AD	80421	480672	8531
34309804832	81031	13320680	80734	4860081AC	80422	480673	8517
34311159879	8243	95477363	80660	4860082AE	80425	480675	8516
34321102567	8243	95477364	80659	4860083AD	80426	480678	8630
34321102567	8695	96179489	8541	4860083AD	80426	480678	8630
34321107139	8243	96212323	8615	K04683996AH	80736	480679	8629
34321108134	8230	96264606	80293	K04683997AH	80735	480680	8628
34321108135	8693	96300046	80013	K04721976AC	80738	480681	8570
34321108135	8693	96300330	80015			480682	8569
34321113183	8693	96300331	80017	<b>Citroen</b>	<b>Akron</b>	480685	8485
34321113184	8243	96300350	80016	<b>Peugeot</b>		480686	8561
34321113184	8695	96308124	80014	1484536080	80007	480691	8519
34321115694	8695	96316525	80011	15894300	8154	480692	8622
34321115695	8693	96320284	80012	445116	8503	480692	8622
34321115697	8230	96328350	80436	480612	8245	480693	8501
34321116515	8172	96328351	80435	480613	8325	480694	8516
34321152274	8458	96345555	80327	480619	8383	480695	80203
34321153107	8230	96345555	80327	480620	8383	480696	8571
34321153109	8458	96387196	80322	480621	8504	480697	80005
34321154904	8457	96397200	80292	480621	8504	480697	80005
34321159524	8908	96397201	80312	480623	8504	480698	80006
34321159717	8907	96397201	80312	480624	8365	4806A0	8940
34321159878	8693	96397206	80314	480624	8365	4806A0	8940
34321159879	8695	96407749	80437	480625	8364	4806A1	8941
34321159881	8693	96483077	80290	480626	8394	4806A3	80205
34321159881	8230	96483077	80290	480626	8625	4806A6	80007
34321159889	8458	96528011	80012	480629	8528	4806A8	8519
34321159890	8457	96534545	80367	480631	8529	4806A9	80003
34321162612	80238	96534546	80296	480632	8532	4806C0	80004
34321162616	80370	96549725	80288	480632	8532	4806C0	80004
34321164002	8911	96625919	80661	480635	8411	4806C1	8622
34321165587	8910	96625920	80662	480636	8410	4806C4	8459
34321503079	80633	96625920	80662	480637	8531	4806C8	80177
34322227102	80320	96625949	80659	480637	8531	4806C8	80177
34322227381	80308	96625950	80660	480639	8533	4806E0	8519
34322227388	80320	96625950	80660	480640	8535	4806E1	80439
34322227489	8037	96682950	80730	480641	8536	4806E2	80438
34324050542	8693	96682952	80731	480642	8534	4806E3	80227
34324050542	8230			480644	8939	4806E5	80224
34324050542	8693	<b>Chrysler</b>	<b>Akron</b>	480645	80204	4806E6	80223
34324050542	8693	04683996AH	80736	480646	8534	4806E6	80223
34324050544	80240	04683997AH	80735	480647	8535	4806E7	80225
34326753610	80949	04721975AC	80737	480648	8536	4806E8	80226
34326757744	80729	04721976AC	80738	480648	8536	4806E9	8485
34326766966	8910	4383838	80429	480650	8529	4806F2	80183
34326766967	80727	4423446	80427	480652	80002	4806F4	80840
		4423447	80428	480653	8530	4806F5	80841
		4509995AC	80419	480654	8531	4806F6	80373
		4509996AC	80420	480655	8620	4806F9	80223
		4683290	80432	480656	8515	4806G0	80224
				480657	8516	4806G1	80349



# TABELLA COMPARATIVA

Catalogo  
0113

Citroen Peugeot	Akron	Citroen Peugeot	Akron	Fiat - Lancia Autobianchi	Akron	Fiat - Lancia Autobianchi	Akron
4806G2	80319	91518816	8528	1472157080	8573	4134496	8086
4806G3	80840	95494014	8387	1479197080	8569	4137282	8084
4806G4	80440	95494973	8575	1484536080	80007	4137664	8047
4806G5	80441	95599101	8351	1489794080	80159	4137665	8046
4806H0	80748	95632790	8029	1498442080	80361	4142639	8152
4806H4	80285	96037346	80265	19202	8001	4156338	8136
4806H5	80749	96037347	8519	2167018	8060	4157473	8072
4806H8	80663	96080322	8515	2191285	8032	4157476	8084
4806H9	80664	96102107	8317	2191288	8059	4158738	8075
4806J0	80665	96109017	8577	2277943	8271	4165325	8150
4806J3	80953	96124223	8548	2277944	8272	4167824	8143
4806J4	80952	96124230	8547	2277945	8273	4167825	8143
4806J9	80745	96132698	8485	2286931	8305	4167826	8144
4806K0	80842	96169410	8328	2289850	8303	4167827	8144
4806K1	80835	ZF04477793	8404	2289851	8304	4170077	8268
4806K2	80225	ZF05952297	8365	2315602	8522	4170091	8150
4806K3	80226	ZF07567861	8410	2347696	8321	4170331	8019
4806K7	80741	ZF07567862	8411	2353829	8322	4170333	8138
4806K8	80744	ZF07570315	8404	2359932	8320	4171159	8142
4806N2	81003			337296	8002	4172382	8141
4806N3	81002	<b>Dacia</b>	<b>Akron</b>	340635	8001	4172384	8140
4806N6	81032	462107756R	80666	340636	8002	4175681	8134
481607	8503	6001547819	8443	4023585	8003	4188308	8270
481609	8326	6001547820	8444	4023586	8021	4188755	8327
481610	8325	6001551097	8444	4023587	8020	4188775	8327
481611	8505	6001551098	8443	4023588	8023	4204594	8281
481619	8506			4023589	8031	4204595	8281
481620	8506	<b>Daihatsu</b>	<b>Akron</b>	4029189	8026	4207037	8072
481621	8385	9004922118	8113	4029190	8027	4213025	8266
481622	8387	9004922127	80446	4029285	8065	4213026	8266
481623	8384	900492214500	80444	4035953	8045	4215163	8266
481624	8406	900492214600	80443	4055916	8047	4232290	8072
481625	8395	9004922168	80447	4061689	8055	4234524	8072
481626	8328	9004922174	80445	4065822	8055	4234525	8066
481627	8354	9004922187	80955	4076975	8046	4234920	8281
481629	8530	9004922188	80954	4079076	8054	4234922	8019
481630	8385	9004922200	80956	4083605	8055	4234923	8083
481632	8534	9004922201	80957	4087084	8076	4234924	8072
481633	8425	9004922202	80958	4087204	8056	4235485	8136
481635	8408	9004922205	80959	4088935	8077	4253987	8266
481636	8425	9004922206	80960	4097910	8001	4258246	8066
75047316	8201	9004922207	80962	4097911	8002	4270732	8266
75422063	8386	9004922281	80961	4097914	8001	4270733	8266
75492063	8386			4097915	8002	4287428	8084
75494063	8386	<b>Fiat - Lancia Autobianchi</b>	<b>Akron</b>	4102046	8047	4293206	8281
7910018158	8384	1306893080	8517	4102047	8044	4294438	8288
7910021226	8383	1311401080	8571	4102048	8046	4294439	8288
7910022619	8383	1311457080	8571	4102049	8054	4296605	8282
7910022622	8385	1314980080	8400	4104668	8067	4296606	8282
7910022623	8387	1367814080	81034	4105804	8266	4299590	8066
91500635	8328	1367815080	81035	4108899	8083	4303019	8316
91500900	8383	1401070380	80318	4111345	8046	4307092	8266
91515816	8528	1401070480	80329	4130343	8031	4307093	8144
91517513	8529	1472155080	8570	4132143	8066	4329073	8144

# TABELLA COMPARATIVA

Fiat - Lancia Autobianchi	Akron	Fiat - Lancia Autobianchi	Akron	Fiat - Lancia Autobianchi	Akron	Fiat - Lancia Autobianchi	Akron
4347579	8359	46803893	80174	5956168	8144	71737662	8404
4348050	8072	46808215	80175	5956169	8362	71737663	8489
4348050	8269	46809897	8919	5959715	8353	71742814	80449
4348056	8269	46809898	8918	5963298	8359	71742815	80298
4349187	8282	46814034	80176	5965862	8352	73503190	8987
4392835	8360	46833121	80177	5966685	8350	7549015	8381
4426826	8315	46834651	8265	5966930	8359	7563601	8424
4428541	8016	46845598	80178	5966948	8363	7563844	8429
4433711	8269	480667	8573	5967970	8425	7563845	8382
4433712	8269	50008743	8920	5968116	8429	7563848	8381
4434663	8144	50012658	8406	5971061	8352	7563849	8352
4458672	8141	504196881	81021	5972813	8382	7563850	8355
4463200	8347	51711589	80179	5980300	8361	7563851	8413
4464149	8314	51718921	80180	598300	8361	7563852	8427
4471492	8367	51725095	80243	5985827	8353	7563854	8414
4473011	8141	51725096	80284	5986091	8353	7566849	8350
4477793	8354	51733731	80181	5986578	8355	7567861	8410
45652040	8406	51745709	80182	5989142	8358	7567862	8411
4590158	8139	51748935	80183	5995681	8405	7569160	8407
46421964	8552	51748936	80183	60652184	8979	7569161	8352
46421965	8553	51757836	80644	60652184	8987	7569592	8353
46421966	8552	51759919	80340	60652184	8979	7569593	8425
46423176	8482	51767150	80184	60816986	8917	7569595	8353
46423177	8559	51776519	80448	7031327	8266	7569850	8355
46423177	8481	51782767	80285	71736914	8351	7569852	8351
46423178	8484	51783802	80335	71736915	8407	7570315	8354
46423178	8560	51790084	80303	71736917	8413	7570316	8408
46423179	8560	51800680	80262	71736919	8403	7573600	8405
46442449	8982	51810448	80964	71736920	8417	7573601	8424
46448474	8606	51814431	80963	71736921	8552	7573602	8424
46448591	8552	51835425	80720	71736922	8484	7573858	8406
46448592	8553	51882545	81033	71736923	8552	7577466	8413
46448593	8553	51902262	80985	71736924	8554	7577467	8428
46454003	8554	543234	8001	71736927	8264	7586906	8404
46460699	8696	5444453	8312	71736940	8400	7586907	8459
4646099	8696	55187211	8983	71736941	8066	7590581	8430
46478973	8613	55189700	8986	71736941	8401	7590582	8431
46481634	8563	55700975	80186	71736949	8353	7590614	8375
46481635	8564	55701046	80187	71736950	8382	7590614	8400
46541771	8997	55701047	80188	71736951	8350	7593340	8144
46542040	8265	55701047	80188	71736956	8425	7593341	8362
46548236	8986	56375	8000	71736957	8354	7593342	8269
46554126	8917	5926217	8356	71736959	8424	7593353	8489
46556013	8613	5930453	8360	71736962	8415	7598927	8426
46556045	8562	5936964	8266	71736963	8531	7603316	8416
46738559	8926	5937834	8017	71736965	8352	7603330	8427
46738613	8915	5941315	8357	71736965	8436	7603482	8382
46745159	8985	5944002	8351	71736966	8482	7609087	8415
46749271	8916	5950690	8408	71736967	8481	7609088	8403
46749648	8984	5952296	8365	71736968	8483	7609957	8404
46760308	8264	5952297	8364	71736969	8553	7614669	8489
46764303	8983	5954071	8356	71736972	8433	7619751	8404
46784455	8917	5954603	8920	71736973	8572	7629987	8413
46786435	8459	5955862	8352	71736976	8571	7635376	8447

# TABELLA COMPARATIVA

Catalogo  
0113

Fiat - Lancia Autobianchi	Akron	Fiat - Lancia Autobianchi	Akron	Fiat - Lancia Autobianchi	Akron	Ford	Akron
7635376	8448	82422135	8320	K04766559AA	81017	1151292	80190
7649589	8425	82422136	8072	K04862210AC	81015	1201141	8914
7655155	8403	82422137	8372	K04862211AC	81016	1207358	80001
7655156	8415	82422138	8373	K04862212AD	81018	1211729	80000
7655166	8433	82422139	8432	K04862213AD	81019	1212748	8998
7662724	8531	82422140	8375	K04862213AE	81019	1213135	80001
7663039	8448	82422141	8400	K04862213AF	81019	1217819	8970
7663850	8355	82422142	8401			1304007	80258
7667806	8417	82422143	8470	<b>Ford</b>	<b>Akron</b>	1309224	80321
7670215	8486	82422144	8066	1000743	8601	1323555	80191
7674976	8403	82430361	8375	1000744	8602	1328519	80246
7674977	8552	82442878	8611	1011293	8922	1361292	80246
7706229	8413	82444203	8412	1013455	8584	1379911	80450
7725169	8920	82468102	8433	1013815	8605	1383533	80965
7726542	8405	82470774	8471	1014204	8607	1387264	80388
7729198	8436	82473716	8572	1018615	8690	1387272	80321
7735008	8482	82483020	8574	1021841	8604	1405494	80306
7735009	8481	838587	8003	1023692	8647	1405497	80246
7735010	8484	8513123	8001	1025018	8648	1424802	80750
7735011	8483	8536129	8156	1026327	8612	1426690	80000
7762435	8921	8544448	8157	1027745	8565	1426700	80001
7781321	8401	8556043	8297	1029544	8610	1426701	80412
7953342	8269	8559121	8318	1029545	8610	1435173	80356
82167018	8060	8559121	8423	1033252	8604	1437504	8914
82191288	8059	8590961	8334	1034192	8605	1438806	80966
82277943	8271	860469	8004	1035269	8610	1438901	80967
82277944	8272	864884	8007	1035270	8610	1444731	8999
82277945	8273	871281	8021	1041774	8583	1487152	8202
82286931	8305	8788688	8295	1041775	8582	1501841	80761
82289850	8303	8789295	8344	1042122	8612	1505870	8200
82289850	8403	8790840	8337	1044504	8925	1522925	80751
82289851	8304	8790849	8337	1049324	8612	1553661	8200
82289950	8303	879112	8366	1051093	80234	1554797	80752
82289951	8304	8794086	8342	1051514	80231	1558834	8200
82315602	8522	8794780	8368	1051516	80233	1563561	8200
82347696	8321	8797066	8077	1064257	8609	1563598	80755
82353829	8322	8797513	8623	1066796	8687	1566996	80758
82359932	8320	880428	8003	1066801	8604	1568859	8206
82383798	8322	880429	8007	1068964	8608	1572002	8203
82390661	8400	894946	8020	1068975	8923	1572003	8204
82392239	8373	894948	8023	1071639	8648	1572004	8200
82392240	8372	895551	8031	1071938	8645	1574611	8209
82393404	8371	8974086	8342	1071939	80307	1613337	8205
82393405	8375	92398510	8303	1071941	80234	1613343	8200
82397551	8372	93803143	8343	1075806	8583	1613344	8209
82397552	8371	93807670	8449	1075807	8582	1613346	8205
823976007	8371	93807671	8624	1089437	8699	1613347	8222
82398510	8303	93809503	8623	1109679	8604	1613348	8222
82401754	8320	9381705	8621	1121359	80258	1613350	8688
82407500	8400	93822492	8624	1121635	8999	1631045	8397
82407500	8470	994998	8026	1124059	80267	1631046	8398
82407501	8066	995001	8027	1130711	80190	1631047	8402
82407928	8401	995002	8065	1148270	80267	1631050	8698
82409618	8399	997250	8028	1151027	8970	1631051	8698

# TABELLA COMPARATIVA

Ford	Akron	Ford	Akron	Ford	Akron	Honda	Akron
1638393	8600	6132910	8565	7272225	8581	01464SV4000	80475
1648810	8463	6135220	8461	7328444	8925	01464SWA000	80668
1648811	8462	6142527	8466	7335770	80244	01464TF0000	80981
1655850	8466	6142528	8467	7335771	8924	01464TL1G00	80763
1655851	8467	6142529	8468	7397508	8584	01465S10010	80464
1655853	8691	6142530	8469	7402348	8555	01465S2G000	80632
1655854	8699	6149181	8691	7402349	8556	01465S30000	80471
1655952	8469	6149182	8699	7402895	8585	01465S6D000	80968
1664958	8689	6158424	8464	77FB228KC	8222	01465SAAG00	80976
1666247	8600	6158425	8465	91AB2282AD	8580	01465SAAG01	80976
1666294	8580	6179304	8565	91AB2282AE	8581	01465SE0030	80019
1666460	8600	6184721	8464	91AB2282BA	8587	01465SE0C33	80019
1671020	80450	6184722	8465	91FB2282AA	8565	01465SEAE00	80462
1671646	80760	6184723	8468	92AB2078AB	8558	01465SJF000	80766
1681131	81037	6483797	8558	92AB2078BB	8556	01465SM4010	80332
1682557	81036	6483798	8557	92AB2078CB	8557	01465SMGE00	80972
1694317	80965	6490376	8581	92AB2078CC	8578	01465SS0010	80467
1702987	81038	6508658	8587	92AB2078DB	8555	01465SV4000	80474
1718847	80751	6510341	8558	92AB2282BB	8602	01465SWA000	80667
1718850	80752	6510342	8557	92FB2282AE	8690	01465SWA010	80667
1913343	8200	6569119	8605	92VB2282AA	8691	01465TF0000	80980
1954516	80084	6577423	8464	93BB2078AD	8645	01465TL1G00	80762
1954519	80084	6577424	8465	93BB2282AA	8646	01466S07000	80283
3898670	80037	6577425	8691	93BB2282CA	8686	01466S2H000	80295
4167824	8463	6577426	8699	93BB2282DD	8649	01466S30000	80472
4167824	8462	6599243	8689	95AB2282DB	8584	01466S50000	80283
4167824	8463	6618202	8555	96FB2078CG	8604	01466S5AJ02	80971
4167824	8462	6618203	8556	96FB2078DA	8605	01466S5AJ04	80971
4167824	8463	6639159	8587	96FB2078EA	8604	01466SA5020	8477
4167824	8462	6643690	8690	96FB2282AC	8607	01466SAA000	80979
4370933	80261	6657327	8557	96FB2282BA	8690	01466SD5020	80025
4409342	80454	6657328	8555	97BG2282AA	8647	01466SE0020	80020
4409343	80453	6667473	8580	97KB2078BB	8610	01466SEAE00	80627
4419593	80637	6714709	8689	97KB2078CB	8610	01466SJF010	80769
4447381	80354	6714710	8565	97KB2282AA	8612	01466SL4010	80313
4447739	80452	6758585	8646	D8RZ2078B	8209	01466SMGE00	80975
4447742	80261	6758587	8686	D91AB2282CB	8689	01466SS0020	80468
4510813	80263	6823334	8602	D9RZ2078A	8209	01466SW3000	80313
480627	8383	6823335	8601	F4CZ2078B	80037	01466SWA000	80669
5007396	8222	6828211	8581			01466TA0A00	80765
6011797	8206	6881658	8558	<b>Honda</b>	<b>Akron</b>	01468S30000	80473
6013897	8202	6881659	8556	01464S10010	80463	01468S5AJ02	80970
6017402	8201	6881660	8557	01464S2G000	80631	01468S5AJ03	80970
6047604	8222	6881661	8555	01464S2H000	80465	01468S5AJ04	80970
6049556	8222	6922621	8649	01464S30000	80470	01468SAA000	80978
6050436	8209	6941702	8558	01464S6D000	80969	01468SEAE00	80628
6050437	8209	6941703	8556	01464SAAG00	80977	01468SJF010	80768
6057402	8201	6941704	8557	01464SAAG01	80977	01468SMGE00	80974
6073100	8688	6941705	8555	01464SE0030	80018	01468SS0010	80469
6085217	8209	6983011	8586	01464SEAE00	80461	01468TA0A00	80764
6095650	8205	7067563	8645	01464SJF000	80767	46410S1AE01	80457
6114613	8460	7111981	8579	01464SM4010	80337	46410SE0003	80018
6125634	8600	7111983	8578	01464SMGE00	80973	46410SE0005	80018
6129003	8462	7271916	8605	01464SS0020	80466	46410SE0013	80018

# TABELLA COMPARATIVA

Catalogo  
0113

Honda	Akron	Hyundai	Akron	Hyundai	Akron	Hyundai	Akron
46410SE0014	80018	587311C000	80489	587371C800	80494	MR129777	80046
46410SE0015	80018	587311C050	80491	587371G300	80772	Innocenti	Akron
46410SH3033	80022	587311E000	80770	587371J300	80907	34742105	8146
46410SK3E01	8478	587311J000	80905	587371P300	80796	38742105	8130
46410SM4013	80337	587311K000	81043	5873722000	80371	38742106	8145
46410SM4014	80337	5873122000	80476	5873722001	80371	38742113	8131
46410SN7003	80455	5873125000	80479	5873729320	80395	38822112	8132
46410SR0N03	951040	5873129020	80481	587372B010	80672	39742105	8130
46410ST3E02	8093	587312B010	80670	587372D300	80390	557401105	8379
46411S1AE01	80458	587312C100	80483	587372E300	80520	557401113	8380
46411SE0003	80019	587312D000	80485	587372E310	80521	5995681	8405
46411SE0005	80019	587312E000	80519	587372L700	80911	6038742113	8131
46411SE0013	80019	587312L000	80909	587372L900	80912	6038822112	8132
46411SE0015	80019	587312S100	80913	587372S100	80915	6557401105	8379
46411SH0A01	80023	5873134001	80503	5873734000	80504	7573858	8406
46411SH3033	80023	5873138010	80507	5873738500	80509	8944033223	8617
46411SH3034	80023	587313A000	80386	587373A000	80515	GBH170	8145
46411SH3043	80024	587313D000	80630	587373A300	80517	Iveco	Akron
46411SH3044	80023	587313Z000	81039	587373Z000	81041	4085611	8064
46411SN7003	80456	587314H000	80774	587374H730	80776	4086648	8063
46411SR0N03	951041	58731H1030	80513	5873802000	80029	4097914	8001
46411ST3E02	8094	5873202010	80026	5873802001	80029	4291513	8293
46430S1AE01	80459	5873211100	80074	587380X300	80904	4291517	8299
46430SE0003	80020	5873217000	80496	587381C000	80492	4291520	8294
46430SE0013	80020	587321C000	80488	587381C800	80493	4294438	8288
46430SE0014	80020	587321C050	80490	587381G300	80773	4294700	8298
46430SE5A01	80020	587321E000	80771	587381J300	80908	4296604	8292
46430SH3933	80300	587321J000	80906	587381P300	80797	8513119	8000
46430SK3E01	80274	587321K001	81044	587382B010	80673	8536129	8156
46430SM4003	80313	5873222000	80477	587382S100	80916	8544440	8296
46430SM4004	80313	5873225000	80478	587383Z000	81042	8544448	8157
46430SM4963	80313	5873229010	80480	587384H730	80777	8546589	8277
46430SN7000	80313	587322B000	80671	5874438001	80505	8546590	8278
46430ST3E01	80300	587322B010	80671	587443A300	80516	8546859	8276
46430ST3E11	80304	587322C100	80482	587443D000	80508	8553080	8300
46430ST3E51	80300	587322D000	80484	5874729310	80495	8553147	8286
46431S1AE01	80460	587322E000	80518	5878702001	80030	8553343	8302
46431SE0931	80021	587322L000	80910	5878802001	80029	8555597	8285
46431SE0932	80021	587322S100	80914	5881126000	80499	8789297	8307
46431SE0933	80021	5873234001	80502	5881126020	80498	8789706	8306
46431SE0934	80021	5873238010	80506	5881143002	80526	8790191	8334
46431SE0935	80021	587323A000	80393	588114A002	80523	8790192	8335
46431SM4951	80291	587323D000	80629	588114A007	80522	8790418	8348
61466SA5020	8078	587323Z000	81040	5881226050	80500	8791112	8366
C01464S2H000	80465	587324H000	80775	5881226150	80501	8791494	8336
		58732H1030	80512	5881243002	80528	8794084	8342
		58733H1000	80511	588134A001	80525	8794797	8340
		58734H1000	80510	5881443003	80527	8796885	8450
		5873702000	80030	588144A001	80524	8796886	8449
		5873702001	80030	58834H1060	80514	8796934	8624
		587370X300	80903	HB407505	80486	8796958	8451
5873102010	80027	5873717000	80316	HB407506	80487	8799289	8344
5873102500	80028	587371A000	80325	MB238160	80046		
587310X000	80902	587371C000	80311	MB238425	80049		
5873117000	80497						



# TABELLA COMPARATIVA

Catalogo  
0113

Mercedes	Akron	Mercedes	Akron	Mitsubishi	Akron	Mitsubishi	Akron
0044282635	8254	6384282135	8930	MB587740	80044	MR129778	80048
1234209128	8013	6384282235	8929	MB587741	80046	MR129779	80044
1234280135	8289	6394280435	80250	MB587742	80048	MR129781	80044
1234280235	8232	6394280835	80251	MB587743	80047	MR129787	80369
1234280535	8178	9014280235	8931	MB587751	80360	MR129788	80366
1234280635	8487	9014280435	8931	MB587752	80346	MR129793	80567
1264260335	8289	9014280635	8931	MB699985	80052	MR129795	80328
1264280135	8243	9014280835	80245	MB699986	80050	MR129799	80391
1264280335	8289	9014289135	80235	MB857426	80391	MR129844	80442
1294280035	8487	9044280435	80249	MB857530	80346	MR129882	80389
1404200048	80282	9044280535	80242	MB857531	80343	MR249392	80394
1428883500	80240	9064280235	80245	MB857532	80360	MR289286	80569
1428953500	8013	9064280535	80245	MB857535	80350	MR289287	80352
1634201348	80192	A2044200748	80809	MB857536	80074	MR407225	80681
1634202048	80560	A2214200548	81000	MB857544	80346	MR407251	80682
1634202548	80559			MB857545	80360	MR407889	80924
1644200348	80998	<b>Mitsubishi</b>	<b>Akron</b>	MB857550	80374	MR493450	80925
1644200448	80998	4544201126	80357	MB857551	80368	MR910915	80414
1644200548	80999	4544201926	80563	MB857552	80049	MR955329	80563
1684280235	8928	4605A071	80357	MB857553	80051	MR955330	80811
1684280335	8927	4605B135	81057	MB857555	80047	MR955461	80564
1684280635	80193	4605B136	81056	MB857558	80048	MR955467	80565
1694280035	80194	4650A083	80814	MB857559	80044	MR955468	80351
1714280035	80236	4650A245	80665	MB857561	80044	<b>Nissan</b>	<b>Akron</b>
2024200148	8068	4650A529	80663	MB857567	80369	066055841	80638
2024280735	8011	4650A530	80664	MB857570	80047	4321279913	8370
2044200748	80809	4650A645	80812	MB857572	80048	4620100Q0E	8942
2044201048	80806	4650A646	80813	MB857573	80044	4620100QAC	80588
2104280035	80236	4650A702	80681	MB950308	8694	4620100QAD	80587
2104280535	8927	MA181409	80074	MB950626	80414	4620100QAE	80211
2114200548	80195	MB004446	80074	MB950627	80561	4620100QAH	80206
2114200648	80195	MB004448	80074	MBA50762	80050	462014A00D	80824
2114200848	80196	MB058509	80044	MM862413	80562	462014A00E	80823
2124200448	80808	MB058592	80046	MMR129796	80589	4620189918	80158
2124280035	80807	MB058593	80044	MMR334054	80606	4620189942	80107
2204200048	80196	MB058595	80372	MN116498	80374	4620189946	80076
2214200248	81001	MB081939	80360	MN116821	80568	46201R8010	80074
2214200548	81000	MB150761	80052	MR1289772	80049	46201R8200	80074
2464200148	81055	MB150762	80050	MR129720	80375	46201Y9502	80107
2464200248	81054	MB238153	80360	MR129721	80363	4620289913	8370
4144280035	80197	MB238154	80074	MR129723	80052	46202H7025	8370
4144280135	80253	MB238156	80346	MR129724	80050	46203G9500	80074
4604280435	80240	MB238160	80046	MR129748	80346	4620400QAA	80208
4604285135	80299	MB238161	80044	MR129749	80343	4620400QAE	80211
4614200748	80240	MB238162	80044	MR129750	80360	4620489911	80080
4614280335	80240	MB238163	80047	MR129751	80593	4620489914	80098
6014280435	8931	MB238164	80044	MR129753	80350	46204C6000	80075
6314280035	8014	MB238165	80052	MR129754	80074	46204M4900	80087
6314280135	80338	MB238166	80044	MR129755	80346	4621001B00	80064
6314280235	80338	MB238425	80049	MR129770	80374	4621001B10	80064
6314280335	80338	MB239151	80045	MR129771	80368	4621001E11	80059
6384280235	8929	MB316287	80051	MR129773	80051	4621001E12	80060
6384280835	8929	MB500452	80048	MR129775	80047	4621001F10	80084
6384281035	8930	MB500748	80566	MR129777	80046		

# TABELLA COMPARATIVA

Nissan	Akron	Nissan	Akron	Nissan	Akron	Nissan	Akron
4621001G00	80082	462105F001	8993	46210JG01B	80687	462145F000	8994
4621001G10	80082	462105F002	8993	46210R8200	80074	462145F001	8994
4621001J10	80072	462105F006	8995	46210Y9501	80105	4621479911	80080
4621001J11	80072	462105F007	8995	4621100G10	80083	4621479913	80098
4621002J10	80073	462105F010	8995	4621100QAA	8944	4621479915	80087
4621009W01	80078	462105F200	8996	4621101A41	80101	4621479916	80063
462100M001	80056	462105F201	8996	4621101A42	80107	4621479917	80053
462100M007	80057	4621060A00	80097	4621101A45	80387	4621489911	80080
462100M011	80056	4621060A10	80097	4621101A46	80076	4621489914	80066
462100M017	80057	4621061A00	80098	4621101A60	80396	4621489915	80087
462100M300	80055	4621061A10	80098	4621101G00	80083	4621489916	80063
4621011E11	80061	4621079916	80063	4621109W01	80077	4621490J00	80090
4621011E12	80062	4621082N10	80579	462110F010	80085	462149C115	80268
462101E01	80061	462108F800	80093	462110F015	80102	46214AX600	80575
462101E02	80062	462108F801	80094	462111HJ0B	80935	46214Q1A15	80087
462101HJ0B	80936	462108H300	80928	462111KK0A	80931	46214Q9015	80063
462101HJ5B	80937	462108H305	80927	4621131G10	80085	4624200QAA	80200
462101KA0B	80934	462108H30A	80928	4621131G11	80085		
462101KA0C	80933	462108H30B	80927	462114A00B	80825	<b>Opel</b>	<b>Akron</b>
462101KK0A	80932	462108H510	80930	4621150J60	80089	08967424	8218
4621020J00	80071	462108H515	80929	4621179944	80079	13136715	80277
4621028B00	80065	462108H51A	80930	4621179966	80081	13237788	80831
4621028B10	80065	462108H51B	80929	4621189942	80107	13327441	80829
462102F001	80091	4621090J00	80088	4621190J00	80089	13327445	80830
462102F002	80092	4621097N00	80086	46211EB01A	80685	13336917	80832
462102F205	80093	4621097N01	80053	46211EB320	80685	13336919	80833
462102F206	80094	462109C008	80095	46211EK400	80085	13336920	80834
462102J007	80577	462109C015	80096	46211G5110	80103	13345580	80834
462102J008	80576	462109C501	80095	46211Y9500	80106	24436542	80342
4621030R00	80086	462109C608	80095	46211Y9600	80106	4293901	8697
4621030R10	80086	462109U00A	80573	4621201A13	8370	4301615	8617
4621031G10	80084	462109U01A	80574	4621279913	8370	4403643	80587
4621031G11	80084	46210AX601	80573	4621289913	8370	4403645	80588
4621032G10	80272	46210AX606	80574	4621300QAA	80201	4403662	80211
4621040R00	80098	46210EB005	80926	4621300QAC	80252	4409165	80201
4621040R10	80098	46210EB00A	80926	4621301A13	80098	4412727	80252
462104B005	80057	46210EB01A	80686	4621301A14	80098	4415698	80206
462104U200	80570	46210EB02A	80926	4621309914	80098	4416297	80200
462104U205	80571	46210EB320	80686	4621379913	80098	4500131	80385
4621050J60	80088	46210EK400	80084	4621379914	80098	4500132	80384
4621050Y02	80053	46210EM01A	80816	462138914	80098	4500133	80208
4621050Y07	80054	46210EM01B	80815	4621389913	80098	4621479913	80098
4621050Y07	80084	46210EM01D	80818	4621401A11	80080	4621479914	80098
4621050Y12	80053	46210EM01E	80817	4621401A14	80098	4621479916	80063
4621050Y12	80085	46210F3600	80636	4621401A15	80087	4621489916	80063
4621050Y15	80054	46210F3600	80638	4621401A16	80063	4700362	8932
4621050Y17	80054	46210G5110	80104	4621401A17	80100	4701124	8933
4621050Y70	80064	46210JD000	80820	4621401A19	80058	4709839	80826
4621051E00	80086	46210JD005	80819	4621401E00	80063	4709847	80828
4621051E10	80578	46210JD610	80822	4621401E10	80063	4709848	80827
4621053A01	80099	46210JD620	80821	462142F001	80239	4804781	80661
4621053A11	80099	46210JG012	80690	462144U010	80572	4804782	80662
4621056E00	80086	46210JG013	80689	462144U011	80273	4808600	80659
4621056E10	80086	46210JG01A	80688	462144U01A	80273	4808601	80660



# TABELLA COMPARATIVA

Catalogo  
0113

Opel	Akron	Opel	Akron	Opel	Akron	Renault	Akron
4818931	80659	562374	80586	9291024	8213	7700313596	8942
532343	8540	562377	8934	93195274	80826	7700314792	8942
5562078	8935	562378	80260	93195319	80828	7700416273	8637
5562079	8936	562437	8210	93195320	80827	7700423975	8636
5562203	80340	562444	8214	93859698	80200	7700423975	8390
5562204	80342	562446	8219	94403322	8617	7700423975	8636
5562230	8937	562447	8218	97124878	80260	7700540425	8097
5562245	80584	562453	8211	97124879	80237	7700541132	8501
5562247	80583	562466	8210	97134830	8617	7700545267	8309
5562248	80582	562467	8214			7700554958	8097
5562249	80581	562472	8213	<b>Polski</b>	<b>Akron</b>	7700619240	8097
5562250	80580	564016	80832	4087204	8056	7700627933	8309
5562260	80277	582357	80333	4108889	8083	7700631755	8404
562037	80334	8932766	8210	4167824	8143	7700631756	8406
562042	80334	90008285	8542	4167826	8144	7700641119	8309
562094	951031	90010524	8540	4170331	8019	7700668132	8406
562095	8615	90077695	8213	4234920	8281	7700674508	8391
562128	80830	90077917	8220	4234922	8019	7700676965	8390
562129	80829	90079377	8221	4234923	8083	7700681960	8504
562130	80833	90121718	8223			7700681968	8392
562131	80834	90147349	8543	<b>Porsche</b>	<b>Akron</b>	7700690564	8332
562147	80831	90168898	8542	211611775A	8241	7700804356	8445
562161	80277	90199759	8223	211611775B	8240	7700804813	8635
562176	80833	90216275	8544	211611775C	8049	7700804814	8446
562236	80834	90217551	80333	477611071B	80590	7700811704	8638
562274	80186	90235567	8540	477611775	80591	7700811705	8639
562275	80188	90235568	8545	7L0611701A	80169	7700824736	8445
562301	8213	90235999	8541	7L0611776	80170	7700832611	8640
562302	8938	90236355	8549	99635513901	80592	7700834731	8631
562304	8617	90374106	8545			7700834863	8495
562306	8220	90425239	8614	<b>Renault</b>	<b>Akron</b>	7700834990	8576
562307	8618	90445758	951031	462100001R	80843	7700840390	8633
562314	8221	90445761	80333	462100006R	80846	7700845510	8992
562321	8223	90468316	8545	462106659R	80938	7701000239	8096
562325	8543	90468319	8545	462107573R	80746	7701050070	80009
562328	8542	90468320	8614	46210JG012	80690	7701050073	80010
562331	8223	90473314	80334	46210JG013	80689	7701204509	8062
562336	8544	90473452	951031	46210JG01A	80688	7701204590	8638
562339	80237	90473452	8615	46210JG01B	80687	7701204831	8641
562342	80333	90495787	8619	5000388495	8946	7701348207	8404
562343	8540	90498319	8934	5000388496	8947	7701348773	8097
562344	8549	90498330	8935	5010422007	80206	7701348799	8096
562345	8545	90498331	8936	5010422009	80207	7701348800	8309
562346	8541	90539252	8619	6025307607	80747	7701348912	8333
562350	8545	9111662	80211	6025307608	8494	7701348919	8332
562352	8614	91142432	8617	6025310456	80257	7701348920	8389
562353	80451	91142436	8618	7700302379	80385	7701349111	8332
562357	80333	9160431	80385	7700302380	80384	7701349126	8383
562358	8545	9160432	80384	7700302387	80208	7701349127	8389
562359	8614	9160433	80208	7700304969	8944	7701349268	8096
562364	8619	9191262	8937	7700308909	8443	7701349304	8500
562366	8617	9191263	8938	7700309009	8946	7701349305	8501
562369	80585	9204000	8932	7700309823	80208	7701349336	8390
562373	8619	9206661	8933	7700312022	8943	7701349337	8392

# TABELLA COMPARATIVA

Renault	Akron	Renault	Akron	Rover	Akron	Saab	Akron
7701349338	8391	8200131599	8576	GBH90274	8949	8965139	8099
7701365330	8096	8200234737	80213	GBH90277	80332	8969206	8099
7701365422	8332	8200249251	80214	GBH90280	8094	90539843	80598
7701365516	8389	8200256166	80309	GBH90281	8093		
7701452077	8324	8200333851	80213	GBH90283	8069	<b>Subaru</b>	<b>Akron</b>
7701454063	8323	8200404264	80200	GBH90285	8070	25531GA140	80116
7701454835	8096	8200572102	80747	GBH90286	8093	25531GA300	80115
7701454836	8309	8200597210	80212	GBH90287	80274	25531GA310	80115
7701540425	8097	8200597218	80747	GBH90288	8070	26531AA001	80110
7701582523	8096	8200735345	81004	GBH90289	80339	26531AA010	80111
7702085308	8499	8200735348	81005	GBH90299	8078	26531AA020	80112
7704001925	8309	8237235	8092	GBH90335	80596	26531AA041	80113
7704001930	8406	8237238	8091	GBH90336	80595	26531AA070	80114
7704001931	8391	8413631	8404	GBH90337	8094	26540AE000	80383
7704001932	8391	84140180	8097	GHP859	8478	26540AE00A	80383
7704001938	8389	8414039	8096	LH5170	8476	26540AE020	80379
7704001939	8392	84140390	8096	LH5173	8477	26540AE02A	80379
7704001943	8383	8414040	8309	SBH10007	8949	26540XA00A9E	80870
7704001948	8389	8414236	8383	SHB000930	80596	26540XA01A9E	80869
7704001950	8501	84142360	8383	SHB10001	8478	26541AE010	80382
7704001951	8635	8414237	8392	SHB10004	80274	26541AE020	80600
7704001952	8497	8422177	8096	SHB10006	8948	26541AF01A	80382
7704001953	8498	8427528	8443	SHB100560	8094	26541FG000	80857
7704001954	8500	8427529	8444	SHB100650	8069	26541FG010	80856
7704001955	8499	9960539	8126	SHB100720	8070	26541XA00A	80872
7704001957	8097			SHB100790	8070	26541XA01A9E	80871
7704001958	8097	<b>Rover</b>	<b>Akron</b>	SHB100920	8093	26550FC000	80378
7704002443	8632	CDU1570	8475	SHB100930	8094	26550FC010	80398
7704002447	8499	GBH 90335	80596	SHB100940	80274	26550FC020	80376
7704003549	8501	GBH 90336	80595	SHB100970	8070	26550FC030	80380
7704003764	8603	GBH182	8472	SHB101070	8078	26550FC040	80377
7704003765	8444	GBH184	8396	SHB101221	80596	26590AE000	80383
7704003846	8641	GBH192	8474			26590AE001	80383
7704003887	8496	GBH193	8475	<b>Saab</b>	<b>Akron</b>	26590AE020	80379
7704003905	8444	GBH220	8688	12779335	80340	26590AJ040	80859
7704003913	8443	GBH223	8473	12841242	80849	26590AJ050	80858
7704003922	8446	GBH227	8688	12841243	80850	26590SC000	80866
7704003931	8501	GBH228	8475	24436541	80340	26590SC010	80865
7704003949	8496	GBH236	8688	24436542	80342	26591AJ060	80861
7704003955	8497	GBH237	8475	4002341	8098	26591AJ070	80860
7704003957	80747	GBH244	8477	4241444	8545	26591SC000	80868
7704003958	8494	GBH245	8476	4426474	8098	26591SC010	80867
7704003961	8495	GBH246	8396	4426490	8098	26591SC011	80867
8200003478	80200	GBH247	8472	4482337	80597	5155083E00	8932
8200003480	80201	GBH248	8473	4483285	8614	5157083E00	80270
8200003481	80252	GBH251	8478	4565719	8541	5158063B00	80108
8200019096	8631	GBH252	8078	4565743	80598	5158063BB0	80108
8200020558	8444	GBH253	8480	4837076	8099	5159063B00	80109
8200045573	80747	GBH254	8948	4908695	80599	725531010	8522
8200045782	8576	GBH255	8949	51759919	80340	725531020	8523
8200057460	80588	GBH90264	80337	8926206	8224	725531030	8522
8200057462	80587	GBH90265	80313	8931784	8225	725531080	8107
8200086894	80211	GBH90266	80291	8931792	8224	725531210	8107
8200129954	80212	GBH90273	8948	8956575	8099	725531280	8111

# TABELLA COMPARATIVA

Catalogo  
0113

Subaru	Akron	Suzuki	Akron	Toyota	Akron	Toyota	Akron
725531400	8111	5158059J00	80279	9008094015	80127	9094702736	80401
799925000	8522	5158060B00	80122	9008094016	80129	9094702742	80127
9004922191	80863	5158060G00	80120	9008094017	80130	9094702743	80128
9004922192	80862	5158062J00000	80605	9008094060	8953	9094702752	80310
9004922193	80864	5158063B00	80108	9008094061	8954	9094702753	80326
		5158075F00	80271	9008094065	8955	9094702757	80137
		5158077K00	80693	9008094066	8956	9094702758	80138
		5158077K00000	80693	9008094067	8955	9094702762	80347
5154060A31	8950	5158080131	80119	9008094068	8963	9094702769	80407
5154065D00	80601	51580B80130	8524	9008094098	80310	9094702780	80315
5154065J00	80692	51580BB0130	8524	9008094099	80326	9094702781	80362
5154065J00000	80692	51580BB0130	8524	9008094099	80326	9094702781	80362
5154080151	80229	5159060B00	80123	9008094133	80611	9094702782	80359
5154081A00	80696	5159064B00	80124	9008094178	80365	9094702783	8965
5154081A00000	80696	5177076G00	8933	9008094199	80405	9094702798	8960
5154085C00	8950	5188080130	8524	9008094200	80406	9094702799	8961
51540C80150	8514			9094502A45	8957	9094702809	8962
51540M68K00000	80874	<b>Talbot</b>	<b>Akron</b>	9094702383	80145	9094702813	80618
5155060A30	8951	156025	8330	9094702409	8537	9094702814	80619
5155060A31	8951	15602500	8246	9094702429	8357	9094702820	80128
5155062J00000	80603	158942	8329	9094702446	8114	9094702821	80127
5155065D00	80602	26899	8128	9094702447	8114	9094702828	80143
5155065J00	80691	27676	8129	9094702465	80133	9094702833	80141
5155065J00000	80691	32045	8154	9094702472	80132	9094702834	80142
5155075F00	80358	480620	8383	9094702477	80135	9094702847	80355
5155079J00000	80449	480621	8504	9094702496	8537	9094702848	80347
5155081A00	80695	480624	8365	9094702497	80126	9094702852	80407
5155081A00000	80695	480625	8364	9094702532	80134	9094702874	80297
5155083E00	8932	480627	8383	9094702533	8539	9094702875	80410
5155084150	80117	480631	8529	9094702540	8357	9094702876	80401
5155085C00	8951	480635	8411	9094702548	80132	9094702877	80403
51550M68K00	80875	480636	8410	9094702550	80134	9094702878	80402
51550M68K00000	80875	480650	8529	9094702565	80125	9094702879	80310
51550M70E10	80278	481611	8505	9094702581	80144	9094702880	80326
51550M70F10	80278	481619	8506	9094702587	80125	9094702887	80127
51550M76G10	80276	481620	8506	9094702588	80145	9094702888	80128
5156065D00	80280	481621	8385	9094702589	80146	9094702904	80131
5156081A00	80939	481623	8384	9094702590	80137	9094702910	8963
5156083031	8952	481627	8354	9094702591	80138	9094702911	8960
5157050A50	80121	481630	8385	9094702599	80607	9094702912	8961
5157060A30	80230	481631	8408	9094702603	80323	9094702913	8964
5157062J00000	80604	543386	8095	9094702614	80612	9094702917	8964
5157076G00	8933	552889	8280	9094702615	80613	9094702921	8965
5157077K00	80694	55288900	8280	9094702634	80129	9094702957	8114
5157077K00000	80694	553843	8308	9094702637	80323	9094702A37	80610
5157079J00000	80298	558480	8293	9094702644	80618	9094702B14	80286
5157083E00	80270	55848000	8293	9094702652	80410	9094702B46	80287
5157084030	80118	5952296	8365	9094702653	80401	9094702B95	80620
5157084050	80118	5952297	8364	9094702657	8962	9094702B96	80344
5157084150	80117	7567861	8410	9094702659	8960	9094702B97	80353
51570B83030	8525	7567862	8411	9094702660	8961	9094702C15	80141
51570BB3030	8525	7910018158	8384	9094702670	80310	9094702C16	80142
51570M68K00	80876	7910022622	8385	9094702671	80326	9094702C23	80399
51570M68K00000	80876	91500900	8383	9094702694	80130	9094702C24	80404
51570M76G10	80259	9750696080	8383	9094702734	80410	9094702C30	8959

# TABELLA COMPARATIVA

Toyota		Akron		Volvo		Akron	
9094702C31	8957	9094702G15	80703	30683332	80216	82427528	8443
9094702C32	8958	9094702G16	80702	30683555	80897	8410251	8389
9094702C39	80302	9094702G20	80701	30714410	80897	8414018	8097
9094702C47	80348	9094702G44	81007	30714413	80898	8414039	8096
9094702C48	80345	90947W2001	80364	3071443	8243	8414040	8309
9094702C50	80324	90947W2002	80439	30714430	8243	8414236	8383
9094702C53	80649	90947W2003	80438	30714434	8243	8414237	8392
9094702C54	80645	90947W2004	80373	30714483	80946	8422177	8096
9094702C55	80646	90947W2007	80941	30714817	80898	8427528	8443
9094702C78	81006	90947W2008	80940	30714820	80217	9169140	80215
9094702C89	80608	90947W2009	80942	30714821	80215	9191400	80301
9094702C90	80609	90947W2010	80943	30792531	80711	91914002	80301
9094702C93	80413	90947W2011	80944	30792533	80712	9209896	80289
9094702C94	80408	90947W2012	80879	30793631	80713	92098961	80289
9094702D02	80647	90947W2013	80878	30793632	80946	9475298	80289
9094702D03	80648	90947W2014	80881	30793874	80713	9485452	80217
9094702D22	80405	90947W2015	80882	30862413	80626	9492354	80241
9094702D23	80406	90947W2016	80880	30862414	8694	<b>Zastava</b>	<b>Akron</b>
9094702D35	80699	90947W2017	80885	30870880	8694	1014105	8266
9094702D76	8957	90947W2018	80885	308708809	8694	1014106	8269
9094702D77	8958	90947W2022	80884	3104418	8228	4253987	8266
9094702D81	80409	90947W2023	80883	31257706	80711	4256246	8269
9094702D82	80400	90947W2029	81061	31257707	80716		
9094702E07	80890	90947W2030	81060	31257709	80712		
9094702E08	80889	90947W2031	81063	31257711	80717		
9094702E11	80891	90947W2032	81062	31261708	80715		
9094702E30	80885	9644033806	80140	31261880	80713		
9094702E33	80879	9694031325	80136	31261882	80946		
9094702E34	80878	9694033205	80136	31305075	80899		
9094702E84	80364	9694033305	80136	31305079	80713		
9094702E85	80365	9694033455	80139	31305080	80708		
9094702F16	80621	9694033456	80139	31305096	80714		
9094702F17	80409	9694033805	80140	31317430	80710		
9094702F20	80699	9694034305	80146	31317431	80709		
9094702F24	80700	9694039855	80147	3204990	8502		
9094702F25	80616	9695033455	8538	32049900	8502		
9094702F26	80617	9695033505	80133	3268705	8242		
9094702F28	80614	9804033605	80148	32687055	8242		
9094702F29	80615			3412685	8634		
9094702F37	80706	<b>Volvo</b>	<b>Akron</b>	34126854	8634		
9094702F42	80705	1229347	8243	3430408	8233		
9094702F43	80704	12293478	8243	3446569	8172		
9094702F49	80650	1229348	8243	34465690	8172		
9094702F50	80651	13292910	8457	3447432	8015		
9094702F51	80652	1329594	8457	34474320	8015		
9094702F52	80653	1329611	8244	3447732	8015		
9094702F60	80413	13296110600	8370	34477320	8015		
9094702F61	80408	13296116	8692	3485043	8015		
9094702F83	80887	1329616	8244	3516568	8693		
9094702F84	80886	30665462	80217	35165687	8693		
9094702F87	80888	30665463	80215	3524397	80289		
9094702F92	81008	30681723	80897	3546535	8244		
9094702F94	81010	30681724	80947	3546813	8692		
9094702F95	81009	30681726	80898	35468131	8244		

# TABELLA COMPARATIVA

Catalogo  
0113

--	--	--	--	--	--	--	--









