

Tappi per serbatoi carburante e urea Fuel and urea tank caps

2019



**NUOVA
FAAB**



FARMA[®]
FABBRICA ACCESSORI RICAMBI MOTO AUTO

1975



1987



Farma nasce nel 1975 come produttore di tappi con chiave per serbatoio carburante auto e moto. Nel 1987 rileva la sua principale concorrente Faab accorpandola nel gruppo e modificandone il nome in Nuova Faab, ma lasciando in vita il marchio originale.

Nel 1992 Farma rileva la fonderia Zamasystem, specializzata nella pressofusione di articoli in lega Zama, sistema a camera calda.

Nel 1998 nasce un nuovo reparto per la produzione di stampi e ciò per dare un ulteriore servizio ai clienti della fonderia ed automotive.

Nel 2009 Farma fonde per incorporazione la fonderia Zamasystem e successivamente accorpa anche la prima azienda rilevata Nuova Faab.

Nel 2014 un reparto iniezione plastica si attiva per la produzione di componenti prodotti Farma, oltre che per i clienti di ambedue i settori, Automotive e fonderia.

Oggi Farma è un'unica realtà che spazia dalla progettazione e produzione di tappi serbatoio e bocchettoni di rifornimento per serbatoi carburante e urea, stampi, alle fusioni in lega zama, allo stampaggio componenti in plastica.

La clientela servita in un mercato globale automotive va dai costruttori macchine movimento terra, trattori, camion al mercato aftermarket auto e camion. La clientela della fonderia copre tutti i più disparati settori.

Farma è certificata ISO 9001 dal 1997, 14001 dal 2014 ed ha in corso di realizzazione la certificazione IATF16949.

Farma was established in 1975 as a producer of caps for fuel tanks

1987, Farma took over main competitor, Faab co, which became part of the group and was re-named Nuova Faab though keeping original trademark.

1992, Farma took over another company Zamasystem foundry, specialized in die cast zamak pieces.

1998 Creation of a brand new tooling department as an additional service offered to all of foundry customers and also automotive ones.

2009, Farma merged with Zamasystem and later with Nuova Faab.

2014, Farma created a plastic injection division, mainly for its products but also for foundry and automotive customers.

Today, Farma is a company specialized in the design and production of caps and filler necks for fuel and urea tanks, see Automotive division, zamak castings see Foundry division.

and plastic components for inhouse requirements and outside customers

Main OE automotive customers, worldwide, come from construction machinery, tractors, trucks.

A complete range of fuel and urea caps is also offered for the aftermarket cars and trucks.

Main zamak foundry customers, European, come from all sectors.

Farma is ISO 9001 and 14001 certified company, on its way to IATF16949.

2018





FARMA : REPARTI PRODUTTIVI

FARMA : PRODUCTION PLANT

**ATTREZZERIA
TOOLING
DEPARTMENT**



**COLLAUDO
QUALITY CONTROL**

**MAGAZZINO
WAREHOUSE**

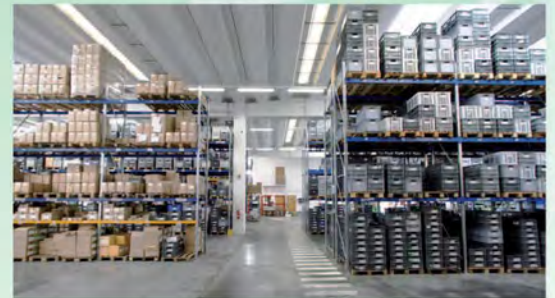
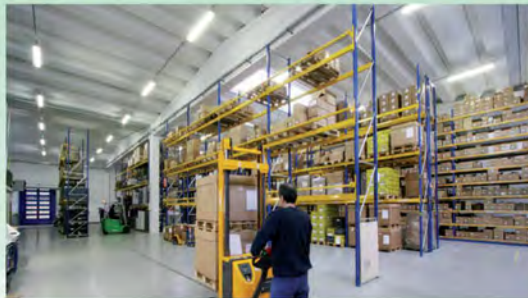

**PRODUZIONE
PRODUCTION**



**MARCATRICE
LASER
LASER MARKING**



**STAMPANTI 3D
3D PRINTERS**



MEGLIO ESSERE UNA CAVALLETTA O UNA FARFALLA? DO YOU PREFER BEING A LOCUST OR A BUTTERFLY?



La cavalletta, da sola, non è pericolosa per l'ambiente.

Quando però sono tante da oscurare il cielo con il loro volo, possono provocare un vero flagello.

La farfalla invece, da sola o in compagnia, rispetta sempre l'ambiente.

Il suo ideale da difendere è l'aria pulita, lo stesso che appartiene oggi a molti automobilisti sensibili al problema inquinamento. Per loro FARMA ha creato l'ECO TAPPO ARIA PULITA, il tappo per il serbatoio carburante che ha superato severi test di controllo. Adeguandosi alla normativa CEE n.70/221 in fatto di sicurezza, è dotato di un dispositivo a valvola brevettato che controlla la dannosissima evaporazione dei gas volatili del carburante.

Se tutti gli automobilisti usassero sulle loro vetture non catalizzate l'ECO TAPPO ARIA PULITA, si viaggierebbe molto più sicuri, si ridurrebbe notevolmente l'inquinamento e si risparmierebbe anche molta energia.

Prove di laboratorio hanno dimostrato che la dispersione dei vapori di carburante delle vetture circolanti in Italia, è quantificabile in una perdita di svariati milioni di euro che si volatilizzano nell'aria. L'ECO TAPPO ARIA PULITA è quindi un piccolo, ma efficace contributo nella lotta contro l'inquinamento..

The locust, by itself, is not a dangerous insect for the environment.

But when there are so many locusts in flight that they blacken the sky, they may provoke a real disaster.

The butterfly on the contrary, alone or in company, is an insect that respects the environment; its ideal is a clean sky in a clean world.

The same ideal belongs to more and more car drivers, who care about air pollution.

For them FARMA made the ECO TAPPO ARIA PULITA, a locking cap which has passed many severe tests.

ECO TAPPO ARIA PULITA is in line with the EEC safety standards (n.70/221) and features a patented valve device, which prevents the extremely harmful evaporation of the volatile gases of car fuel.

If all car drivers used ECO TAPPO ARIA PULITA, we would all travel more safety, significantly reduce pollution and save a great deal of energy as well. Several lab tests proved that the dispersion of fuel vapours from the gas tank of the Italian car circulating, means a financial loss equal to many million euro.

ECO TAPPO ARIA PULITA is then a small, but effective contribution to the struggle against air pollution..

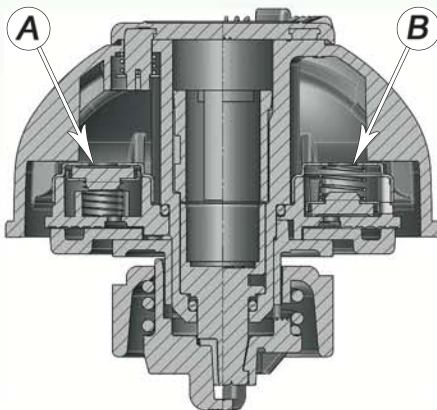

A - VALVOLA DI DEPRESSIONE:
è aperta solo per consentire all'aria di entrare nel serbatoio.

A - DEPRESSURE VALVE:
it opens only when tank needs ventilation.

B - VALVOLA DI PRESSIONE:
è aperta per consentire all'aria di uscire dal serbatoio.

B - PRESSURE VALVE:
it opens only when tank needs ventilation.













**TAPPI ECO CONFORMI
ALLE NORMATIVE EUROPEE**



***ECO CAPS CONFORM
TO EU NORMS***

**ELENCO MARCHE E TIPI DI VEICOLI
CAR MAKES AND TYPES LIST**









ELENCO MARCHE E MODELLI DI VETTURA - CAR MAKES AND MODELS

MARCA E TIPO DI VETTURA CAR MAKES / MODELS					MARCA E TIPO DI VETTURA CAR MAKES / MODELS				
ABARTH					ARO DACIA				
500	3/08 ▶	065216	025244	OKD620	M 461 C		015310		0BZ369
500 Cabrio	8/10 ▶	065216	025244	OKD620	240 - 241 - 242 - 243 - 244		015306	025232	0BZ378
595 Berlina, Cabrio	9/12 ▶	065216	025244	OKD620					
695	9/14 ▶	065216	025244	OKD620					
Punto Evo	8/10 ▶ 6/12	065216	025244	OKD620					
Punto	6/12 ▶	065216	025244	OKD620					
ALFA ROMEO					AUDI				
4C (for automatic filler neck)	13 ▶	000853			50		015319	025207	0BZ359
75 - 90		067707	023339	0QD291	60 L - 75 Variant - 80	▶ 69	015310		0BZ369
145	▶ 98	067786	023338	0QD608	80	69 ▶ 72	015342	025206	0BZ361
	99 ▶ 00	065216	025244	OKD620		79 ▶ 83	015317	025219	0BZ454
146	▶ 98	067786	023338	0QD608		84 ▶ 87	015316	025208	0BZ388
	99 ▶ 00	065216	025244	OKD620		88 ▶	067754	023334	0QD449
147	12/00 ▶ 3/11	065216	025244	OKD620	80 Cabriolèt	93 ▶	067754	023334	0QD449
155		067775	023317	0QD482	90	▶ 87	015316	025208	0BZ388
156	98 ▶ 6/00	067754	023334	0QD449		88 ▶	067754	023334	0QD449
	7/00 ▶ 07	065216	025244	OKD620	90 Super		015310		0BZ369
159 Berlina, SW	9/05 ▶	065216	025244	OKD620	100 - 200	84 ▶ 87	015316	025208	0BZ388
164	94 ▶	067754	023334	0QD449		88 ▶	067754	023334	0QD449
166	98 ▶ 6/00	067754	023334	0QD449	100 Avant L, GL, LS, GLS, 5E	73 ▶ 80	015319	025207	0BZ359
	7/00 ▶	065216	025244	OKD620	100 GL, GL Aut.	▶ 73	015311		0BD459
1750		015310		0BZ369	100 LS Coupé	72 ▶	015319	025207	0BZ359
A11 - A12 - F11 - F12		015310		0BZ369	100, 200, CD5D	80 ▶ 83	015317	025219	0BD454
Alfa Camioncino (small lorry) 30-32-35-40 AR8	▶ 83	067922		0QD592	Autounion 1000 kg.		015310		0BZ369
	84 ▶	065504	025430	OKD473	Coupé	90 ▶	067754	023334	0QD449
Alfa Camioncino (small lorry) 35 AR 8 doppia cab. (double cab.)	▶ 83	067749	023349	0QD130	DKW Furgon - F102 - Sureleve Verhoogte		015310		0BZ369
	84 ▶	065504	025430	OKD473	G, GT, Quattro	▶ 83	015317	025219	0BD454
Alfa Furgoni (van) (1ªserie) 30-35 AR 8		067749	023349	0QD130		84 ▶ 87	015316	025208	0BZ388
Alfa Furgoni (van) (2ªserie) 30-32-35 40 AR 8	▶ 83	065001		OKD060	Quattro	88 ▶	067754	023334	0QD449
	84 ▶	065504	025430	OKD473	A1	7/10 ▶	067754	023334	0QD449
Alfetta G.T. 1.8		015310		0BZ369	A2	12/00 ▶	067754	023334	0QD449
Giulia - Giulia GT	▶ 82	015310		0BZ369	A3 3/5 porte (3/5 door) - Cabrio	10/96 ▶ 9/13	067754	023334	0QD449
Giulia Diesel	▶ 77	015310		0BZ369		9/13 ▶	065240	025248	OKD657
Giulia	6/16 ▶	065216	025244	OKD620	A4 Berlina, SW	95 ▶ 10/07	067754	023334	0QD449
Giulietta	5/10 ▶	065216	025244	OKD620		10/07 ▶	065240	025248	OKD657
GT	1/04 ▶ 2/11	065216	025244	OKD620	A5 Coupé	2/07 ▶	065240	025248	OKD657
GTV	95 ▶ 6/00	067754	023334	0QD449	A5 Cabrio	4/09 ▶	065240	025248	OKD657
	7/00 ▶ 05	065216	025244	OKD620	A5 Sportback	8/09 ▶	065240	025248	OKD657
Junior Z 1300		015310		0BZ369	A6	94 ▶ 2/11	067754	023334	0QD449
Mito	8/08 ▶	065216	025244	OKD620		2/11 ▶	065240	025248	OKD657
Spider	95 ▶ 6/00	067754	023334	0QD449	A6 S.W.	▶ 6/11	067754	023334	0QD449
	7/00 ▶ 9/11	065216	025244	OKD620		6/11 ▶	065240	025248	OKD657
Stelvio	3/17 ▶	065216	025244	OKD620	A7	11/10 ▶	065240	025248	OKD657
					A8	96 ▶ 2/10	067754	023334	0QD449
						2/10 ▶	065240	025248	OKD657
ALFASUD					Q2	9/16 ▶	065240	025248	OKD657
Arna		067754	023334	0QD449	Q3	8/11 ▶	065240	025248	OKD657
33 - 33(4x4)		067707	023339	0QD291	Q5	9/08 ▶	065240	025248	OKD657
					Q7	05 ▶	065240	025248	OKD657
					R8	07 ▶	067754	023334	0QD449
AMERICAN MOTORS					TT	4/06 ▶ 10/14	065240	025248	OKD657
Matador		015310		0BZ369	V8	90 ▶	067754	023334	0QD449



LEGENDA		Codice tappo con chiave ▶ Anno = fino al ...
		Codice tappo senza chiave



KEY		Cap code with key ▶ Year = up to ...
		Cap code without key

ELENCO MARCHE E MODELLI DI VETTURA - CAR MAKES AND MODELS









MARCA E TIPO DI VETTURA CAR MAKES / MODELS					MARCA E TIPO DI VETTURA CAR MAKES / MODELS				
FIAT					<i>Prosegue - Continued</i> FIAT				
1100 D, H, Special - 1100/58		015342	025206	0BZ361	Ducato Maxi	90 ▶ 93	065007		0KD139
1100 R		067749	023349	0QD130	Duna		065001		0KD060
1100 R Familiare (estate)	▶ 67	015342	025206	0BZ361	Duty		065504	025430	0KD473
	68 ▶	067702	023201	0QD475	Fiorino	88 ▶ 93	065001		0KD060
124 Spider	▶ 68	067702	023201	0QD475		94 ▶ 11/06	067775	023317	0QD482
124, Special T, Spider, Sport	69 ▶	067749	023349	0QD130		12/07 ▶	065216	025244	0KD620
125		067749	023349	0QD130	Freemont	5/11 ▶ 11/16	067802	023354	0QD656
126		067749	023349	0QD130	Idea	12/03 ▶ 6/12	065216	025244	0KD620
126 bis		065007		0KD139	Marea	7/98 ▶	065216	025244	0KD620
127 C, L, CL	77 ▶	065001		0KD060	Marea berl. e s.w.	▶ 6/98	067786	023338	0QD608
127 diesel	▶ 82	015311		0BD459	Marea Diesel	▶ 6/98	067787	023343	
127 Fiorino Pick-up - Rustica		015311		0BD459	Multipla		065216	025244	0KD620
127 Panorama - Fiorino - Sport	83 ▶ 87	065001		0KD060	Palio Weekend	97 ▶ 03	067754	023334	0QD449
127 Panorama D. - Fiorino Diesel	83 ▶ 87	065001		0KD060	Panda	10/03 ▶ 10/12	065216	025244	0KD620
127, special		067749	023349	0QD130	Panda (for automatic filler neck)	10/12 ▶	000849		
128		067749	023349	0QD130	Panda 1100 Hobby, Young, College	01 ▶	065216	025244	0KD620
128 3P - Sport		065001		0KD060	Panda 30	▶ 4/84	067749	023349	0QD130
1300 - 1500	▶ 68	015314		0BZ375		4/84 ▶	067709	023341	0QD217
131 Mirafiori L, CL		067749	023349	0QD130	Panda 34		067709	023341	0QD217
131 Mirafiori Panorama L - CL		067749	023349	0QD130	Panda 45		067709	023341	0QD217
131 Supermirafiori	▶ 81	067749	023349	0QD130	Panda 4x4	87 ▶ 2/01	065007		0KD139
132 2000		067749	023349	0QD130		3/01 ▶ 10/12	065216	025244	0KD620
147 Brasile		015311		0BD459	Panda 750 - 1000 - Panda Elett.		065007		0KD139
238 - E Panorama - E Andal - 241		067749	023349	0QD130	Panda 750, 1000 Diesel		065007		0KD139
500	▶ 68	015314		0BZ375	Panda 900 Young	87 ▶ 12/00	065007		0KD139
	69 ▶ 75	067702	023201	0QD475	Panda Van	12/03 ▶ 10/12	065216	025244	0KD620
500 (Nuova)	9/07 ▶	065216	025244	0KD620	Penny Diesel		065001		0KD060
500 Cabrio	8/09 ▶	065216	025244	0KD620	Punto	98 ▶ 5/11	065216	025244	0KD620
500 L, 500 Living (for automatic filler neck)	12 ▶	000849			Punto Evo	10/09 ▶ 7/12	065216	025244	0KD620
600	▶ 64	015314		0BZ375	Punto (Grande)	10/05 ▶	065216	025244	0KD620
	65 ▶	067702	023201	0QD475	Punto - Punto Team (colore verde - green colour)	▶ 97	067769	023343	0QD481
850, Coupé, Familiare (estate)	6/67 ▶	067702	023201	0QD475	Punto Diesel - Turbodiesel - Van (colore rosso - red colour)	▶ 97	067785	023343	0QD600
900 T, Shango, Promiscuo, 900 E Pulmino Bus		067702	023201	0QD475		▶ 97	067783	023343	0QD599
Argenta		065007		0KD139	Punto (Grande) Van	06 ▶	065216	025244	0KD620
Autocarri (con bocc.M80x2) Trucks (filler neck M80x2)		067922	023466	0QD592	Qubo	9/08 ▶	065216	025244	0KD620
Barchetta	▶ 98	067754	023334	0QD449	Regata (bocch. plastica - plastic filler) (bocch. Lamiera - metal filter)	84 ▶	067703	023203	0QD153
	99 ▶	065216	025244	0KD620		84 ▶	067749	023349	0QD130
Brava, Bravo	7/98 ▶	065216	025244	0KD620	Ritmo (bocch. plastica - plastic filler) (bocch. Lamiera - metal filter)	84 ▶	067703	023203	0QD153
Brava D., Bravo D. (rosso - red)	▶ 6/98	067787	023343			84 ▶	067749	023349	0QD130
Brava, Bravo (verde - green)	▶ 6/98	067786	023338	0QD608	Scudo	▶ 1/07	065515		0BD609
Bravo	3/07 ▶ 10/14	065216	025244	0KD620	Scudo Benz. (petrol)	2/07 ▶	015379	025245	0BD647
Campagnola (Savio)		067749	023349	0QD130	Scudo Diesel	2/07 ▶	015381	025247	0BD648
Cinquecento	92 ▶ 93	065513		0KD564	Sedici	4/06 ▶	067754	023334	0QD449
	93 ▶ 98	065007		0KD139	Seicento	5/98 ▶	065216	025244	0KD620
Croma	▶ 86	065007		0KD139	Stilo	10/01 ▶ 08	065216	025244	0KD620
	87 ▶ 2/97	067769	023343	0QD481	Stilo Station Wagon	1/03 ▶ 7/09	065216	025244	0KD620
	6/05 ▶ 2/11	065216	025244	0KD620	Strada	6/06 ▶	067754	023334	0QD449
Croma Diesel	▶ 86	065007		0KD139	Tipo - Tipo (restyling'93) - Tempra		067775	023317	0QD482
	87 ▶ 2/97	067787	023343		Tipo (for automatic filler neck)	1/16 ▶	000849		
Dino		067702	023201	0QD475	Ulysse	▶ 6/02	067921	023351	0QD601
Doblò, Doblò Cargo	12/00 ▶	065216	025244	0KD620	Ulysse Benz. (petrol)	7/02 ▶ 11/10	015379	025245	0BD647
Ducato	▶ 87	067749	023349	0QD130	Ulysse Diesel	7/02 ▶ 11/10	015381	025247	0BD648
	88 ▶ 89	067709	023341	0QD217	Uno (escluso CS - excluded CS)		065007		0KD139
	90 ▶ 93	065007		0KD139	Uno CS		065001		0KD060
	94 ▶ 98	067769	023343	0QD481	Uno Diesel		065013		
	99 ▶	065216	025244	0KD620					



Continua - To be continued



LEGENDA		Codice tappo con chiave	▶ Anno = fino al ...
		Codice tappo senza chiave	Anno ▶ Anno = dal...al... Anno ▶ = dal ...

KEY		Cap code with key	▶ Year = up to ...
		Cap code without key	Year ▶ Year = from...up to... Year ▶ = from ...





ELENCO MARCHE E MODELLI DI VETTURA - CAR MAKES AND MODELS

MARCA E TIPO DI VETTURA CAR MAKES / MODELS					MARCA E TIPO DI VETTURA CAR MAKES / MODELS				
INFINITI					IVECO				
EX	9/10 ▶	067754	023334	0QD449	Autocarri (con bocch. M80x2) Trucks (filler neck M80x2)	▶ 73	067922	023466	0QD592
FX	9/10 ▶	067754	023334	0QD449	Autocarri (con bocch. M80x2) Trucks (filler neck M80x2)	74 ▶	067922		0QD592
G Berlina	9/10 ▶	067754	023334	0QD449	Autocarri (con ø introduz. 80) Trucks (inside ø80)	88 ▶			
G Cabrio	9/10 ▶	067754	023334	0QD449	Eurotech - Eurostar - Eurotrakker Eurocargo 130 à 180E - 4x4		019858	025428	0HH507
G Coupè	9/10 ▶	067754	023334	0QD449	Autocarri (con bocch. 80 p.6 plastica) Trucks (plastic filler neck 80 p.6) Eurocargo	▶ 02	067928	023400	
M	9/10 ▶	067754	023334	0QD449	Autocarri (con bocch. ø65 p.6,5 plastica) Trucks (plastic filler neck ø65 p.6,5) Eurocargo	03 ▶	067924	023418	0QD621
Q30	2/16 ▶	065240	025248	0KD657	Autocarri (con bocch. ø65 p.6,5 plastica) Trucks (plastic filler neck ø65 p.6,5) Eurocargo Euro 4	06 ▶	067966	023418	0QD654
Q50	1/14 ▶	067754	023334	0QD449	Autocarri(con bocch.a baionetta int.(58,8) Trucks (inside bayonet filler neck ø58,8) Eurocargo Euro 6	11/13 ▶	065564	025470	
Q70	11/15 ▶	067754	023334	0QD449	Daily	99 ▶	065216	025244	0KD620
QX30	8/16 ▶	065240	025248	0KD657	Daily 2006		065232	025244	0KD655
QX50	5/14 ▶	067754	023334	0QD449	Daily - Grinta	84 ▶	065504	025430	0KD473
QX70	11 ▶	067754	023334	0QD449	Daily - Turbodayly	6/91 ▶ 98	067928	023400	
INNOCENTI (British-Leyland)					Daily 30 F8 - Grinta 30,8 - 35,8 cam. (small lorry) doppia cabina (double cab) (con ø introduz. 60) (inside ø60)				
A 40		015310		0BZ369		▶ 83	067749	023349	0QD130
Mini 90, 120		015310		0BZ369		84 ▶	065504	025430	0KD473
Mini Cooper MK2, MK3, 1300		015311		0BD459	Daily 30 F8 Camioncino(øintroduz.60) Daily 30 F8 Light Van (inside ø60)	84 ▶	065504	025430	0KD473
Mini Minor T		015310		0BZ369	Daily 30 F8 Camioncino (con bocch.M80x2) Daily 30 F8 Light Van (filler neck M80x2)	▶ 83	067922		0QD592
Minimatic - Mini Minor, MK2, MK3, 1001, Export, 1003 - Mini 1000		015311		0BD459	Daily 30 F8 Minibus e Combi - Grinta 30,8 - 35,8 (1° serie)		067749	023349	0QD130
Regent		015310		0BZ369	Daily 30 F8 Minib. e Combi - Grinta 30,8 - 35,8 Furgoni (van) (2° serie)	▶ 83	065001		0KD060
INNOCENTI (Nuova)					Daily 45,10 - 49,10				
650		015310		0BZ369	Daily City	▶ 02	067928	023400	
De Tomaso		015310		0BZ369	Daily City Van	03 ▶	067924	023418	0KD621
Elba - Nuova Elba 1,5 cat. - Happy		065007		0KD139	Daily S2000	11 ▶	065232	025244	0KD655
Mille - Mini 90 - 3 cilindri		015310		0BZ369	Daily Euro 6	06/14 ▶	065216	025244	0KD620
Mille Clip, Super Clip	95 ▶	065007		0KD139	Stralis		019884	025428	
Porter		015319	025207	0BZ359	Stralis Euro 6, Trakker Euro 6		065564	025430	
INTERNATIONAL					Talentò				
Autocarri (con bocch.M80x2) Trucks (filler neck M80x2)		067922	023466	0QD592	Tector 60 → 180E	▶ 02	067928	023400	
D 1300 - D 1500 - 1300 - 1600 - 1602 P - 1604 - 1800 - 1804		015310		0BZ369	Serbatoio AdBlue ventilato AdBlue vented tank Modelli Models : Eurocargo, Stralis	03 ▶	067924	023418	0KD621
ITALJET					Serbatoio AdBlue ventilato AdBlue vented tank Eurocargo, Trakker, Stralis Euro 6				
Microcar Sprint		065007		0KD139			065559	025469	





LEGENDA		Codice tappo con chiave ▶ Anno = fino al ...
		Codice tappo senza chiave ▶ Anno = dal...al...
		Anno ▶ = dal ...



KEY		Cap code with key ▶ Year = up to ...
		Cap code without key ▶ Year = from ...
		Year ▶ Year = from ...



ELENCO MARCHE E MODELLI DI VETTURA - CAR MAKES AND MODELS

MARCA E TIPO DI VETTURA CAR MAKES / MODELS				
JAGUAR (British-Leyland)				
Daimler Double six V12		015306	025232	0BZ378
E-Pace	7/17 ▶	067802	023354	0QD656
E type 4.2		015310		0BZ369
E type V12 Coupé (3ªserie)		015311		0BD459
E type V12 Spider (3ªserie)		015311		0BD459
E type VL 2, 3.4, 3.8 S		015311		0BD459
F-Pace	1/16 ▶	067802	023354	0QD656
F-Type	4/13 ▶	067802	023354	0QD656
Jaguar XJS		015311		0BD459
Sovereign		015306	025232	0BZ378
XE	1/15 ▶	067802	023354	0QD656
XF	12/07 ▶	067802	023354	0QD656
XJ	1/10 ▶	067802	023354	0QD656
XK Cabrio	5/06 ▶	067802	023354	0QD656
XK Coupé	5/06 ▶	067802	023354	0QD656
JEEP				
CJ5 Cherokee	▶ 2/96	015342	025206	0BZ361
Cherokee	2/96 ▶ 99	067754	023334	0QD449
	99 ▶ 5/14	067802	023354	0QD656
CJ7 Renegade - Laredo		015342	025206	0BZ361
Compass	06 ▶	067802	023354	0QD656
Grand Cherokee	▶ 99	067754	023334	0QD449
Grand Cherokee (for automatic filler neck)	11 ▶	000853		
Patriot	▶ 11/11	067802	023354	0QD656
Renegade (for automatic filler neck)	10/14 ▶	000849		
Wrangler	▶ 06/09	067754	023334	0QD449
	06/09 ▶	067802	023354	0QD656
JOHN DEERE				
435 - 530 - 630		015310		0BZ369
KAESSBOHRER				
Autocarri (con ø introd. 80)				
Trucks (inside ø80)		019858	025428	0HH507
KIA				
Carens	2/01 ▶	067754	023334	0QD449
Carnival	6/99 ▶ 2/11	067754	023334	0QD449
Cee'd berlina	3/07 ▶	067754	023334	0QD449
Cee'd station wagon	10/07 ▶	067754	023334	0QD449
Cerato	12/04 ▶ 08	067754	023334	0QD449
Clarus		067754	023334	0QD449
K2500 Camioncino (small lorry)	12/04 ▶	067754	023334	0QD449
Magentis	12/03 ▶ 5/09	067754	023334	0QD449
Niro	3/17 ▶	067754	023334	0QD449
Opirus	12/03 ▶ 08	067754	023334	0QD449
Picanto	4/04 ▶	067754	023334	0QD449
Pregio Furgone (van)	12/04 ▶	067754	023334	0QD449
Pride		067754	023334	0QD449
Rio	1/01 ▶	067754	023334	0QD449
Sephia		067754	023334	0QD449
Shuma		067754	023334	0QD449
Sorento	7/02 ▶	067754	023334	0QD449
Soul	5/09 ▶	067754	023334	0QD449









Continua - To be continued

MARCA E TIPO DI VETTURA CAR MAKES / MODELS				
<i>Prosegue - Continued</i>				
KIA				
Sportage		067754	023334	0QD449
Stonic	11/17 ▶	067754	023334	0QD449
Stinger	4/18 ▶	067754	023334	0QD449
Venga	4/10 ▶	067754	023334	0QD449
KLOCKNER HUMBOLT DEUTZ				
Autocarri (con ø introd. 80)				
Trucks (inside ø80)		019858	025428	0HH507
LADA				
Niva	95 ▶	067749	023349	0QD130
Samara 2108 - 2109 - 21081 - 21093		067779	023315	0QD485
Samara Cabrio		067779	023315	0QD485
1200 - 1300 - 1500 - 1600 - 2105 - 2107		067749	023349	0QD130
LAMBORGHINI				
Espada - Jarama		067749	023349	0QD130
LANCIA				
Autocarri (con bocch. M80x2)				
Trucks (filler neck M80x2)	75 ▶	067922		0QD592
Beta		067749	023349	0QD130
Dedra		067775	023317	0QD482
Delta	93 ▶ 2/96	067775	023317	0QD482
	3/96 ▶ 00	067786	023338	0QD608
	6/08 ▶	065216	025244	0KD620
Delta Diesel	87 ▶	067787	023343	
Delta - Prisma	87 ▶ 93	067769	023343	0QD481
Delta - Prisma - Trevi	▶ 86	067749	023349	0QD130
Delta HF integrale	91 ▶ 2/95	065007		0KD139
Delta HPE (escluso Turbo-Turbo excluded)	95 ▶	067775	023317	0QD482
Delta HPE 2000 Turbo	3/95 ▶	067786	023338	0QD608
Flavia	6/12 ▶	067802	023354	0QD656
K	11/94 ▶ 00	067754	023334	0QD449
Lybra	99 ▶ 05	065216	025244	0KD620
Musa	9/04 ▶	065216	025244	0KD620
Phedra Benz. (petrol)	8/02 ▶ 2/10	015379	025245	0BD647
Phedra Diesel	8/02 ▶ 2/10	015381	025247	0BD648
Thema	▶ 86	065007		0KD139
	87 ▶ 94	067769	023343	0QD481
Thema Diesel	▶ 86	065007		0KD139
Thema D. - Prisma D.	87 ▶ 94	067787	023343	
Thesis	7/02 ▶ 2/09	065216	025244	0KD620
Y verde (green)	▶ 97	067785	023343	0QD600
Y	98 ▶ 04	065216	025244	0KD620
Ypsilon	8/03 ▶ 9/06	065216	025244	0KD620
Ypsilon 2006	10/06 ▶ 4/13	065216	025244 E	0KD620
Z	9/94 ▶ 98	067921	023351	0QD601
	99 ▶	015375		0BD626
Voyager	6/12 ▶ 3/15	067802	023354	0QD656



LEGENDA		Codice tappo con chiave	▶ Anno = fino al ...
		Codice tappo senza chiave	Anno ▶ Anno = dal... al... Anno ▶ = dal ...

KEY		Cap code with key	▶ Year = up to ...
		Cap code without key	Year ▶ Year = from ... Year ▶ Year = from ... up to..



ELENCO MARCHE E MODELLI DI VETTURA - CAR MAKES AND MODELS

MARCA E TIPO DI VETTURA CAR MAKES / MODELS					MARCA E TIPO DI VETTURA CAR MAKES / MODELS				
LAND ROVER					MASERATI				
90 - 110		019866		0BD525	Biturbo		067749	023349	0QD130
Defender	94 ▶ 10/01	019870	025430	0HH589					
	11/01 ▶	067754	023334	0QD449					
Discovery	▶ 6/09	067754	023334	0QD449					
	7/09 ▶	067802	023354	0QD656					
Freelander	12/06 ▶	067802	023354	0QD656					
Range Rover	▶ 90	015317	025219	0BD454					
	95 ▶ 2/02	067754	023334	0QD449					
	3/02 ▶ 5/07	019656	025244	0HH591					
	6/07 ▶	067802	023354	0QD656					
Range Rover Evoque	6/11 ▶	067802	023354	0QD656					
Range Rover Sport	6/07 ▶	067802	023354	0QD656					
Range Rover Velar	6/17 ▶	067802	023354	0QD656					
LEYLAND (British-Leyland)					MASSEY FERGUSON				
Sherpa camioncino (small lorry)		015310		0BZ369	Mod. 65		015310		0BZ369
LEXUS					MAZDA				
CT	2/11 ▶	067754	023334	0QD449	121	▶ 93	065204	025210	0KD522
GS	95 ▶	067754	023334	0QD449		93 ▶ 4/96	067754	023334	0QD449
IS	05 ▶	067754	023334	0QD449	121 3 e 5 porte (3 and 5 door)	4/96 ▶	065210		0KD610
LS	95 ▶	067754	023334	0QD449	323	▶ 79	015324	025232	0BD455
NX	14 ▶	067754	023334	0QD449		80 ▶	065204	025210	0KD522
RX	09 ▶	067754	023334	0QD449	323 4WD	90 ▶	067754	023334	0QD449
LIGIER					323 F Lantis				
162 GL Diesel	96 ▶	065007		0KD139	526		067754	023334	0QD449
M.A.N.					626				
Autocarri (con ø introduz. 80)		019858	025428	0HH507		78 ▶	065204	025210	0KD522
Trucks (indide ø80)		019858	025428	0HH507		94 ▶	067754	023334	0QD449
TGL - TGM - TGS - TGX Euro 6		019858	025428	0HH507	818	▶ 77	015324	025232	0BD455
TGE		065240	025248	0KD657		78	065204	025210	0KD522
Seratoio AdBlue ventilato		065549	025467		929	▶ 73	015324	025232	0BD455
AdBlue vented tank						74 ▶	065204	025210	0KD522
MAGIRUS DEUTZ					BT50				
Autocarri (con ø introduz.80)		019858	025428	0HH507	CX-3	4/07 ▶	067754	023334	0QD449
Trucks (indide ø80)		019858	025428	0HH507	CX-5	6/15 ▶	067754	023334	0QD449
MAHINDRA					CX-7				
Genio	15 ▶	067754	023334	0QD449	Demio	▶ 03	067754	023334	0QD449
Xuv500		067754	023334	0QD449	E 1600		065204	025210	0KD522
MCC					Light Van				
Smart	9/98 ▶ 2/99	067754	023334	0QD449	Mazda2	81 ▶	015324	025232	0BD455









LEGENDA

 Codice tappo con chiave ▶ Anno = fino al ...
 Anno ▶ Anno = dal...al...
 Codice tappo senza chiave Anno ▶ = dal ...



KEY



 Cap code with key ▶ Year = up to ...
 Year ▶ Year = from...up to...
 Cap code without key Year ▶ = from ...

ELENCO MARCHE E MODELLI DI VETTURA - CAR MAKES AND MODELS







MARCA E TIPO DI VETTURA CAR MAKES / MODELS					MARCA E TIPO DI VETTURA CAR MAKES / MODELS				
MERCEDES					<i>Prosegue - Continued</i> MERCEDES				
180 - 190 - 220	▶ 68	015310		0BZ369	Axor 2528, 2533, 2535, 2540, 2543		019858	025428	0HH507
190 - 200	69 ▶ 84	015311		0BD459	Autocarri con p.t.t. oltre 3,5T (trattori a 2 assi) : Trucks with capacity over 3,5T (tractors with 3 axis) :				
	84 ▶	015317	025219	0BD454	Actros Linea (Euro 3) 1832, 1836, 1841, 1844, 1846, 1850, 1854, 1858				
200 GE, 250 GD, 280 GE, 300 GD Fuoristrada (off road)	▶ 90	065504	025430	0KD473	Actros Linea (BlueTec 4 / BlueTec 5) 1832, 1836, 1841, 1844, 1846, 1848, 1851, 1855, 1860				
206 Furgone (van)		015310		0BZ369	Actros Cantiere 1832, 1841, 1844, 2032, 2041, 2044, 2046, 2050		019858	025428	0HH507
207 Camioncino (small lorry)		015311		0BD459	Corriere (Bus)		019858	025428	0HH507
207 Furgone (van)		015509	025219	0BD465	C180 - C200 - C220 - C250		015311	025219	0BD459
220 - 230 - 240 - 250 - 280 - 300	69 ▶	015311		0BD459	Citan	12 ▶	015377	025251	0BD627
300 SE - 300 CE 24 Cabriolet	93 ▶	015311		0BD459	Classe A	97 ▶ 01	015317	025219	0BD454
306 Furgone (van)		015310		0BZ369		02 ▶	019656	025244	0HH591
307 Camioncino (small lorry)		015311		0BD459	Classe B	6/05 ▶	019656	025244	0HH591
307 Furgone (van)		015509	025219	0BD465	Classe C berlina, SW	94 ▶ 01	015317	025219	0BD454
350		015311		0BD459		01 ▶	019656	025244	0HH591
406 Camioncino (small lorry)		015311		0BD459	Classe E berlina, SW	95 ▶ 01	015317	025219	0BD454
407 Furgone (van)		015310		0BZ369		01 ▶	019656	025244	0HH591
408, 508 Camioncino (small lorry)		015311		0BD459	Classe G	91 ▶	015317	025219	0BD454
420 Coupé		015317	025219	0BD454	Classe GL	06 ▶ 3/16	067802	023354	0QD656
450		015311	025219	0BD459	Classe ML	▶ 11/99	015317	025219	0BD454
508, 608 Furgone (van)		015310		0BZ369		12/99 ▶ 3/05	067754	023334	0QD449
600		015311	025219	0BD459		3/05 ▶	067802	023354	0QD656
608 Furgone (van)	79 ▶	015509	025219	0BD465	Classe S	94 ▶ 01	015317	025219	0BD454
813 Camioncino (small lorry)		015311	025219	0BD459		01 ▶	019656	025244	0HH591
Autocarri leggeri (small lorry): 100D - 208D - 308D - 310B - 310D - 408D 410D - 508D - 609D - 709D - 711D - 809 - 814 D		015317	025219	0BD454	Classe V	10/96 ▶ 03	015317	025219	0BD454
Autocarri pesanti (Trucks) : 814, S - 817 - 914, AK - 1117 - 1314 K, AK - 1317 - 1320, S - 1517, K - 1520 - 1826, L, S - 1833 L, LL, LS - 1922 K, AK - 1935, S - 1948, S - 2433 L, LL, - 6x2 - 2629 K, 2629 AK M.O. - 2635 K, S M.O.		019858	025428	0HH507	CL	02 ▶	019656	025244	0HH591
Autocarri con p.t.t. oltre 3,5T (cabinati 4x2 fino a 7,5t) : Trucks with capacity over 3,5T (cabin cruisers 4x2 up to 7,5t) :		019858	025428	0HH507	CLA	3/13 ▶	019656	025244	0HH591
Atego 715, 815, 818, 822		019858	025428	0HH507	CLK	6/97 ▶ 01	015317	025219	0BD454
Autocarri con p.t.t. oltre 3,5T (cabinati 4x2 da 7,6 a 12t) : Trucks with capacity over 3,5T (cabin cruisers 4x2 from 7,6 to 12t) : Atego 1018, 1022, 1023, 1218, 1222, 1223, 1228		019858	025428	0HH507		02 ▶	019656	025244	0HH591
Autocarri con p.t.t. oltre 3,5T (cabinati 4x2 da 12,1 a 18t) : Trucks with capacity over 3,5T (cabin cruisers 4x2 from 12,1 to 18t) : Atego 1318, 1322, 1323, 1328, 1523,1528		019858	025428	0HH507	CLS	11/04 ▶	019656	025244	0HH591
Autocarri con p.t.t. oltre 3,5T (cabinati a 3 e a 4 assi) : Trucks with capacity over 3,5T (cabin cruisers with 3 and 4 axis) :					Corriere (bus)		019656	025244	0HH591
Actros Linea (Euro 3) 2532, 2536,2541, 2544, 2546, 2550, 2554, 2558 Actros Linea (BlueTec 4 / BlueTec 5) 2532, 2536, 2541, 2544, 2546, 2548, 2551, 2555, 2560					GLA	4/14 ▶	019656	025244	0HH591
Actros Cantiere 2636, 2641, 2644, 2646, 2650, 3336, 3341, 3344, 3346, 3350, 4141, 4144, 4146, 4150					GLC	8/15 ▶	019656	025244	0HH591
					GLE	6/15 ▶	019656	025244	0HH591
					GLK	02 ▶ 01/16	019656	025244	0HH591
					SL	▶ 01	015317	025219	0BD454
						01 ▶	019656	025244	0HH591
					SLC	3/16 ▶	019656	025244	0HH591
					SLS cabrio	8/11 ▶	019656	025244	0HH591
					SLS coupé	4/10 ▶	019656	025244	0HH591
					SLK	02 ▶	019656	025244	0HH591
						6/96 ▶ 01	015317	025219	0BD454
					Sprinter	01 ▶ 12/16	019656	025244	0HH591
						▶ 01	015317	025219	0BD454
					Vito	02 ▶	065202	025212	0KD640
					Serbatoio AdBlue ventilato		015317	025219	0BD454
					AdBlue vented tank		065549	025467	
					Serbatoio AdBlue ventilato				
					AdBlue vented tank				
					Actros Euro 6		065573	025467	



Continua - To be continued



LEGENDA		Codice tappo con chiave ▶ Anno = fino al ...
		Codice tappo senza chiave

KEY		Cap code with key ▶ Year = up to ...
		Cap code without key









ELENCO MARCHE E MODELLI DI VETTURA - CAR MAKES AND MODELS

MARCA E TIPO DI VETTURA CAR MAKES / MODELS				MARCA E TIPO DI VETTURA CAR MAKES / MODELS					
MG (British-Leyland / Rover)				MORRIS (British-Leyland)					
110		012302	0AZ381	1100 MK II - Van Pick-Up - 1300 Automatic - Traveller		012302	0AZ381		
1300 MK 2		012302	0AZ381	Mini clubman Estate - Combi - 850 - 1275 GT		015310	0BZ369		
MG Midget MK III - MGB GT, Hardtop		015310	0BZ369	Mini MK II, 1000, 1000 SDL		015311	0BD459		
ZR	1/02 ▶	015338	0BZ363	Morris 850, Cooper		015310	0BZ369		
				Morris Cooper S MK II		015311	0BD459		
MINI (British-Leyland)				MOSKVITCH					
Clubman - Cooper S	▶ 9/01	015311	0BD459	Moskvitch - Moskvitch 1500 e Famil. - 412 - 427 - 2137 Station Wagon - 2140		015310	0BZ369		
Estate - 850 - 1275 GT	▶ 9/01	015310	0BZ369						
1000, SDL - 1001 - 1003	▶ 9/01	015311	0BD459						
MINI (Bmw)				MOTOR IBERICA					
Mini (all models)	10/01 ▶	019656	025244	0HH591	Ebro F 275	81 ▶	065001	0KD060	
MITSUBISHI				NISSAN					
3000 GT		067754	023334	0QD449	200 SK	89 ▶	067754	023334	0QD449
ASX	9/10 ▶ 8/15	067754	023334	0QD449	350Z	5/03 ▶ 6/09	067754	023334	0QD449
	8/15 ▶	015379	025245	0BD647	370Z	6/09 ▶	067754	023334	0QD449
Canter	99 ▶ 14	019858	025428	0HH507	3000		067754	023334	0QD449
Carisma	5/96 ▶	067754	023334	0QD449	Almera berlina, NX, Tino		067754	023334	0QD449
Colt	78 ▶	065204	025210	0KD522	Bluebird		067754	023334	0QD449
	3/94 ▶ 4/12	067754	023334	0QD449	Cabstar (NT400)	95 ▶ 07	067754	023334	0QD449
Colt Cabrio	06/06 ▶	067754	023334	0QD449		08 ▶	015536	025238	0BZ403
Eclipse 2,0 GS		067754	023334	0QD449	Cabstar Adblue Tank Euro6		065573	025467	
Eclipse Cross	1/18 ▶	067754	023334	0QD449	GT-R	07 ▶	067754	023334	0QD449
Galant	80 ▶	065204	025210	0KD522	Evalia	12 ▶	067754	023334	0QD449
Grandis	11/05 ▶ 3/11	067754	023334	0QD449	Interstar	01 ▶	015377	025251	0BD627
L200 bus	80 ▶	065204	025210	0KD522	Juke	8/10 ▶	067754	023334	0QD449
L300 bus	80 ▶	065204	025210	0KD522	Maxima QX		067754	023334	0QD449
Lancer 4P-5P	79 ▶ 94	065204	025210	0KD522	Micra	11/92 ▶	067754	023334	0QD449
	3/94 ▶ 7/13	067754	023334	0QD449	Micra C+C	12/05 ▶ 1/11	067754	023334	0QD449
Light Van - Colt - Galant	81 ▶	015324	025232	0BD455	Murano	04 ▶ 12/15	067754	023334	0QD449
Outlander	11/04 ▶ 2/07	067754	023334	0QD449	Note	4/06 ▶ 7/17	067754	023334	0QD449
	3/07 ▶ 12/12	015383	025249	0BD649	NV200	10 ▶	067754	023334	0QD449
	12/12 ▶	067754	023334	0QD449	NV300	17 ▶	015377	025251	0BD627
Pajero - Pick Up	▶ 12/95	065204	025210	0KD522	NV400	11 ▶	015377	025251	0BD627
Pajero 3P-5P	1/96 ▶	067754	023334	0QD449	Pathfinder	05 ▶	067754	023334	0QD449
Pick Up L200	10/00 ▶	067754	023334	0QD449	Patrol	5/98 ▶ 11/09	067754	023334	0QD449
Sapporo	81 ▶	065204	025210	0KD522	Pickup		067754	023334	0QD449
Space Gear		067754	023334	0QD449	Pixo	6/09 ▶	067754	023334	0QD449
Space Star	11/98 ▶	067754	023334	0QD449	Primera berlina e Station Wagon		067754	023334	0QD449
Space Runner - Space Wagon	91 ▶	067754	023334	0QD449	Pulsar	11/14 ▶	067754	023334	0QD449
Space Wagon	▶ 91	015324	025232	0BD455	Qashqai	2/07 ▶	067754	023334	0QD449
	91	065204	025210	0KD522	Serena	1/93 ▶	067754	023334	0QD449
Transporter	80 ▶	065204	025210	0KD522	Sunny 1300 - 1500		067754	023334	0QD449
					Terrano	95 ▶ 3/05	067754	023334	0QD449
					Trade		065001		0KD060
					Vanette - Patrol - King cab. - Terrano		015330	025206	0BD458
					Vanette cargo 2,3 D	8/95 ▶	067754	023334	0QD449
					Vanette Pratic		065204	025210	0QD449
					X-Trail	10/01 ▶	067754	023334	0QD449
					Serbatoio AdBlue ventilato, fino a Euro5				
					AdBlue vented tank, up to Euro 5	▶	065557		
MORETTI									
126 Minimaxi		067749	023349	0QD130					
127 Midimaxi - Paguro		067749	023349	0QD130					



LEGENDA		Codice tappo con chiave ▶ Anno = fino al ...
		Anno ▶ Anno = dal...al...
		Anno ▶ = dal ...

KEY		Cap code with key ▶ Year = up to ...
		Year ▶ Year = from...up to..
		Year ▶ = from ...



ELENCO MARCHE E MODELLI DI VETTURA - CAR MAKES AND MODELS

MARCA E TIPO DI VETTURA CAR MAKES / MODELS					MARCA E TIPO DI VETTURA CAR MAKES / MODELS				
PEUGEOT					PIAGGIO				
104	80 ▶	012510		0AZ382	Ape MP - MP 500 - MP 600 - MPV - TM - Diesel		015308		0OD097
106 - Rallye		015563	025215	0BD552	Ape P50 serb. Metallo (metal tank)		012308		0AD478
107	12/05 ▶	067754	023334	0QD449	Ape P50 serb. Plastica (plastic tank)		012312		0AD489
108	6/14 ▶	067754	023334	0QD449	Porter		015319	025207	0BZ359
205		068412		0AZ382					
206	98 ▶ 01/13	015575		0BD635					
207 Benz. (petrol) - berlina, SW, CC	5/06 ▶	015379	025245	0BD647					
207 Diesel - berlina, SW, CC	5/06 ▶	015381	025247	0BD648					
207 berlina	2/13 ▶	015379	025245	0BD647					
208	3/12 ▶	015379	025245	0BD647	PLYMOUTH				
305	80 ▶	012510		0AZ382	Fury	78 ▶	067754	023334	0QD449
306 3 e 5 porte (3 and 5 door)	94 ▶	067921	023351	0QD601	Horizon	79 ▶	067754	023334	0QD449
307 Benz. (petrol) - berlina, SW, CC	6/01 ▶	015379	025245	0BD647					
307 Diesel - berlina, SW, CC	6/01 ▶	015381	025247	0BD648					
308 berlina, SW, CC	10/07 ▶	015379	025245	0BD647	POLSKI-FIAT				
404 - 504		012300		0AZ380	125 P - 126 P - 127 P - 132 P		067749	023349	0QD130
405		067921	023351	0QD601					
407	5/04 ▶ 10/11	015383	025249	0BD649					
407 S.W.	9/04 ▶ 10/11	015383	025249	0BD649	PONTIAC				
407 Coupè	12/05 ▶ 4/12	015383	025249	0BD649	Bonneville	75 ▶	067754	023334	0QD449
504		012300		0AZ380	Firebird	75 ▶	067754	023334	0QD449
504 U01		065202	025212	0KD640	Grand Prix	75 ▶	067754	023334	0QD449
505 - Break	84 ▶	012307		0AZ395	Trans Sport 2,3 16V		067754	023334	0QD449
505 (escluso Break) (Break excluded)	▶ 84	012300		0AZ380					
508 berlina, SW	3/11 ▶	015379	025245	0BD647					
604	▶ 11/76	012300		0AZ380					
	11/76 ▶	015316	025208	0BZ388	PORSCHE				
605		067921	023351	0QD601	911 - 944	90 ▶	067754	023334	0QD449
806		067921	023351	0QD601	924	81 ▶ 90	067753	023337	0QD476
807 Benz. (petrol)	11/02 ▶ 10/13	015379	025245	0BD647	Boxster	96 ▶	065240	025248	0KD657
807 Diesel	11/02 ▶ 10/13	015381	025247	0BD648	Cayenne	03 ▶	065240	025248	0KD657
1007 Benz. (petrol)	5/05 ▶ 2/11	015379	025245	0BD647	Cayman	05 ▶	065240	025248	0KD657
1007 Diesel	5/05 ▶ 2/11	015381	025247	0BD648	Macan	14 ▶	065240	025248	0KD657
2008	5/13 ▶	015379	025245	0BD647	Panamera	5/09 ▶	065240	025248	0KD657
3008	7/09 ▶	015379	025245	0BD647					
4007	8/07 ▶ 12/13	015379	025245	0BD647					
5008	12/09 ▶	015379	025245	0BD647					
Bipper	08 ▶	065216	025244	0KD620					
Bipper Tepee	3/09 ▶	065216	025244	0KD620					
Boxer	94 ▶ 06	067769	023343	0QD481					
	06 ▶	065216	025244	0KD620					
Expert Benz. (petrol)	2/07 ▶	015379	025245	0BD647					
Expert Diesel	2/07 ▶	015381	025247	0BD648					
J 5	▶ 87	067749	023349	0QD130					
	88 ▶	067709	023341	0QD217					
J 7	▶ 68	067702	023201	0QD475					
	69 ▶	012300		0AZ380					
J 9	69 ▶	012300		0AZ380					
Partner Benz. (petrol)	08 ▶	015379	025245	0BD647					
Partner Diesel	08 ▶	015381	025247	0BD648					
Partner Tepee Benz. (petrol)	7/08 ▶	015379	025245	0BD647					
Partner Tepee Diesel	7/08 ▶	015381	025247	0BD648					
RCZ	10 ▶ 8/15	015379	025245	0BD647					
Traveller	16 ▶	015379	025245	0BD647					

LEGENDA

 Codice tappo con chiave ▶ Anno = fino al ...
 Anno ▶ Anno = dal...al...
 Codice tappo senza chiave Anno ▶ = dal ...



KEY



 Cap code with key ▶ Year = up to ...
 Year ▶ Year = from...up to...
 Cap code without key Year ▶ = from ...

ELENCO MARCHE E MODELLI DI VETTURA - CAR MAKES AND MODELS





MARCA E TIPO DI VETTURA CAR MAKES / MODELS					MARCA E TIPO DI VETTURA CAR MAKES / MODELS				
RENAULT					<i>Prosegue - Continued</i> RENAULT				
12 Break		015506	025232	0BZ368	Magnum (con serb. In lamiera 2 alette / Fe metal tank 2-lug)		019858	025428	0HH507
14	▶ 77	015506	025232	0BZ368	Magnum(con serb. In plastica/plastic tank)		067957		0QD637
15 - 17 - 177		015506	025232	0BZ368	Mascott	1/99 ▶	067957		0QD637
16		015506	025232	0BZ368	Master	▶ 98	015306	025232	0BZ378
18	▶ 9/81	015506	025232	0BZ368	Master	99 ▶	015377	025251	0BD627
18 Break	10/81 ▶	015345	025211	0BZ385	Master 4x2 - 4x4		019858	025428	0HH507
19 - 19 Spyder		065503		0KD514	Master 6x4/8x4 (con serb. In lamiera 2 alette / Fe metal tank 2-lug)	7/92 ▶	019858	025428	0HH507
20	▶ 77	015506	025232	0BZ368	Master 6x4/8x4 (con serb. In lamiera 3 alette / Fe metal tank 3-lug)	7/92 ▶	019882	025442	
	77 ▶	015506	025232	0BZ368	ME/SE/CE/190/180/210	▶ 11/01	019882	025442	
21	▶ 92	015345	025211	0BZ385	Mégane - 2 porte (2 door)	▶ 96	065205		0BD580
	93 ▶	067754	023334	0QD449	Mégane Cabriolet	▶ 12/00	065205		0BD580
25		015345	025211	0BZ385	Mégane	3/96 ▶ 12/02	015377	025251	0BD627
30	▶ 77	015506	025232	0BZ368	Mégane (for automatic filler neck)	03/16 ▶	000852		
	77 ▶	015306	025232	0BZ378	Midliner Grande-Bretagne		019882	025442	
4 - 6 - 7 - 8 - 10 - 12 - 12 L, TL, TR, TS		015306	025232	0BZ378	Midlum (con serb. In lamiera 2 alette / Fe metal tank 2-lug)		067957		0QD637
5	▶ 84	015306	025232	0BZ378	Midlum (con serb. In lamiera 3 alette / Fe metal tank 3-lug)		019858	025428	0HH507
5 - Supercinque	84 ▶	065200	025234	0KD472	Midlum (con serbatoio in plastica / plastic tank)		067957		0QD637
9 - 11		015345	025211	0BZ385	Midlum Export (con serb. In lamiera 2 alette / Fe metal tank 2-lug)		019858	025428	
Alaskan	11/17 ▶	067754	023334	0QD449	Midlum Expert (con serbatoio in plastica / plastic tank)		067957		0QD637
Autocarri (con serb. in lamiera 2 alette)					Modus	11/04 ▶	015377	025251	0BD627
Trucks (Fe metal tank 2-lug)		019858	025428	0HH507	MS300 Sudamerica		019858	025428	0HH507
Autocarri (con serb. in lamiera 3 alette)					PG230/280		019858	025428	0HH507
Trucks (Fe metal tank 3-lug)		019882	025442		Premium (con serb. In lamiera 2 alette / Fe metal tank 2-lug)		019858	025428	0HH507
Autocarri (con serb. in plastica)					Premium (con serbatoio in plastica / plastic tank)		067957		0QD637
Trucks (plastic tank)		067957		0QD637	Premium PR (con serb. In lamiera 2 alette / Fe metal tank 2-lug)		019858	025428	0HH507
AE 380/385TI/420TI/500/520	▶ 9/96	019882	025442		Premium PR (con serbatoio in plastica / plastic tank)		067957		0QD637
AE Magnum 390/420TI/430/470/560	4/96 ▶ 5/00	019858	025428	0HH507	Premium TR	2/96 ▶	019858	025428	0HH507
Capture	6/13 ▶	015377	025251	0BD627	Premium Tracteur 4x2 (FAB22CC)	10/00 ▶	019858	025428	0HH507
Cargo - Dauphine - Estafette - Furgonette - Gordini - Ondine - Super Galion - SG 2 - SG 4 - Super Goelette		015306	025232	0BZ378	PS 150/160		019882	025442	
Clio	3/98 ▶	015377	025251	0BD627	Safrane		065205		0BD580
Clio S.W.	2/09 ▶	015377	025251	0BD627	Scénic benz. e diesel	▶ 6/03	015377	025251	0BD627
Clio Van	3/98 ▶	015377	025251	0BD627	Scenic (for automatic filler neck)	05/09 ▶ 11/16	000855		
Espace	▶ 91	015306	025232	0BZ378		11/16 ▶	000852		
	91 ▶ 98	065205		0BD580	Serie "B"		019882	025442	
	2/98 ▶ 11/02	015377	025251	0BD627	Serie "C" (con serb. In lamiera 2 alette / Fe metal tank 2-lug)		019858	025428	0HH507
Espace (for automatic filler neck)	15 ▶	000852			Serie "C" (con serb. In lamiera 3 alette / Fe metal tank 3-lug)		019882	025442	
Express	▶ 91	015506	025232	0BZ368	Serie "G" (con serb. In lamiera 2 alette / Fe metal tank 2-lug)		019858	025428	0HH507
	91 ▶ 11/94	065507		0BD553	Serie "G" (con serb. In lamiera 3 alette / Fe metal tank 3-lug)		019882	025442	
	12/94 ▶	065519		0BD651	Serie "G" Manager (con serb. In lamiera 2 alette / Fe metal tank 2-lug)		019858	025428	0HH507
Fuego	▶ 9/81	015306	025232	0BZ378	Serie "G" Manager (con serb. In lamiera 3 alette / Fe metal tank 3-lug)		019882	025442	
Fuego Turbo	10/81 ▶	015345	025211	0BZ385			019858	025428	0HH507
JE 13/15		019882	025442				019882	025442	
Kadjar	8/15 ▶	067754	023334	0QD449			019882	025442	
Kangoo 4 porte (4 door)	97 ▶ 08	065521		0BD652			019858	025428	0HH507
Kangoo 5 porte (5 door)	1/00 ▶ 08	065541		0BD653			019858	025428	0HH507
Kangoo	08 ▶	015377	025251	0BD627			019858	025428	0HH507
Kangoo Express	97 ▶	065521		0BD652			019882	025442	
	08 ▶	015377	025251	0BD627			019858	025428	0HH507
Kerax		019858	025428	0HH507			019882	025442	
Koleos	7/08 ▶ 2/16	067754	023334	0QD449			019882	025442	
Laguna Berlina, S.W.	94 ▶ 98	065205		0BD580			019858	025428	0HH507
	99 ▶ 10/07	015377	025251	0BD627			019882	025442	
M/S 4x4 & INCENDIE	▶ 11/96	019882	025442				019858	025428	0HH507
M210 4x4	12/96 ▶	019882	025442				019882	025442	

Continua - To be continued
Continua - To be continued





LEGENDA		Codice tappo con chiave	▶ Anno = fino al ...
		Codice tappo senza chiave	Anno ▶ Anno = dal...al... Anno ▶ = dal ...

KEY		Cap code with key	▶ Year = up to ...
		Cap code without key	Year ▶ Year = from...up to... Year ▶ = from ...



ELENCO MARCHE E MODELLI DI VETTURA - CAR MAKES AND MODELS



MARCA E TIPO DI VETTURA CAR MAKES / MODELS				
VOLKSWAGEN				
Amarok		067754	023334	0QD449
Autocarri MT 8136 - 9136 (con ø introd. 80) Trucks (inside ø80)		019858	025428	0HH507
Beetle 2.0 - 1.9 TDI	4/99 ▶ 10/99	067754	023334	0QD449
Bora	5/99 ▶ 05	067754	023334	0QD449
Caddy Combi - Van		067754	023334	0QD449
California		067754	023334	0QD449
Caravelle	80 ▶	015509	025219	0BD465
	12/95 ▶ 01	015363	025217	0BD527
	02 ▶	067754	023334	0QD449
CC	3/12 ▶	065240	025248	0KD657
Corrado		067754	023334	0QD449
Crafter	06 ▶	065202	025212	0KD640
Derby		015319	025207	0BZ359
Eos	06 ▶ 6/12	065240	025248	0KD657
Fox	6/05 ▶ 7/11	067754	023334	0QD449
Furgone (van) Bus - Joker	80 ▶	015509	025219	0BD465
Golf (escluso Cabriolet - Cabriolet excluded)	84 ▶ 11/12	067754	023334	0QD449
Golf	11/12 ▶	065240	025248	0KD657
Golf (fino al telaio n°1783187614) (up to frame n°1783187614)		015514	025206	0BD467
Golf Cabriolet		019818	025210	0HH007
	6/98 ▶ 11/12	067754	023334	0QD449
Golf Diesel	▶ 83	015515	025207	0BZ370
Golf GL (dal telaio n°1783187615) (from frame n°1783187615)	78 ▶ 83	015515	025207	0BZ370
Golf GTI	81 ▶ 83	015515	025207	0BZ370
	84 ▶ 6/12	067754	023334	0QD449
Jetta		015310		0BZ369
K 70		065202	025212	0KD640
LT46		067754	023334	0QD449
Lupo	9/98 ▶ 05	015319	025207	0BZ359
Maggiolone (Beetle)	68 ▶ 73	067753	023337	0QD476
	74 ▶	065240	025248	0KD657
Maggiolino	10/11 ▶	015363	025217	0BD527
Multivan	02 ▶	067754	023334	0QD449
New Beetle	11/99 ▶ 10/11	067754	023334	0QD449
New Beetle cabriolet	5/03 ▶ 10/11	067754	023334	0QD449
Passat Berlina, SW	▶ 76	015319	025207	0BZ359
	81 ▶ 83	015317	025219	0BD454
	88 ▶ 3/05	067754	023334	0QD449
	3/05 ▶	065240	025248	0KD657
Passat Diesel	▶ 81	015319	025207	0BZ359
Passat Topic - Syncro	84 ▶ 87	015316	025208	0BZ388
Polo	11/94 ▶	067754	023334	0QD449
Polo - Polo II	▶ 11/94	015319	025210	0BZ359
Polo Fun	5/04 ▶	067754	023334	0QD449
Scirocco (fino al telaio n°5382040975) (up to frame n°5382040975)	▶ 78	015514	025206	0BD467
Scirocco (dal telaio n°5382040976) (from frame n°5382040976)	78 ▶	015515	025207	0BZ370
Scirocco GT		015514	025206	0BD467
Scirocco GT X	84 ▶	015316	025208	0BZ388
Scirocco GTI	81 ▶ 83	015317	025219	0BD454
Scirocco	10/08 ▶	065240	025248	0KD657

Continua - To be continued







MARCA E TIPO DI VETTURA CAR MAKES / MODELS				
<i>Prosegue - Continued</i> VOLKSWAGEN				
Sharan	▶ 00	067754	023334	0QD449
	00 ▶ 10/10	015363	025217	0BD527
	10/10 ▶	065240	025248	0KD657
T-Roc	9/17 ▶	065204	025210	0KD522
Taro	▶ 95	065204	025210	0KD522
	96 ▶	067754	023334	0QD449
Tiguan	07 ▶	065240	025248	0KD657
Touareg	2/03 ▶ 9/10	067754	023334	0QD449
	9/10 ▶	065240	025248	0KD657
Touran	6/03 ▶	067754	023334	0QD449
Transporter	90 ▶ 01	015363	025217	0BD527
	02 ▶	067754	023334	0QD449
Up	1/12 ▶	067754	023334	0QD449
Vento		067754	023334	0QD449
VOLVO				
142 - 144 - 145 - 164 - 242 - 244	▶ 77	015505	025209	0BD464
240 - 244, L, DL, GL - 245 DL, DLE - 262 Coupé	78 ▶	067754	023334	0QD449
264	▶ 77	015505	025209	0BD464
264 GL, GLE	78 ▶	067754	023334	0QD449
440 - 460 - 480		067754	023334	0QD449
66		015310		0BZ369
740 - 760 - 850 - 940 - 960		067754	023334	0QD449
Autocarri con p.t.t. oltre 3,5T (cabinati da 7,6 a 12t) :				
Trucks with capacity over 3,5T (cabin cruisers from 7,6 to 12T) :				
FL6 L 180-8,0 - FL6 L 180-10 - FL6 L 180-11,5 - FL6 L 220-11,5 - FL6 L 220-12 - FL6 H 250-11,5 - FL6 H 250-12		065504	025430	0KD473
Autocarri con p.t.t. oltre 3,5T (cabinati da 12,1 a 18t) :				
Trucks with capacity over 3,5T (cabin cruisers from 12,1 to 18T) :				
FL6 H 250-15 - FL6 H 250-17 - FL6 E 250-18		065504	025430	0KD473
Autocarri con p.t.t. oltre 3,5T (cabinati da 12,1 a 18t) :				
Trucks with capacity over 3,5T (cabin cruisers from 12,1 to 18T) :				
FM-260 - FM-300 - FM-340 - FM-380 - FM-400 - FM-440 - FM-480 - FH-400 - FH-440 - FH-480 - FH-520		019858	025428	0HH507

Continua - To be continued



LEGENDA		Codice tappo con chiave ▶ Anno = fino al ...
		Codice tappo senza chiave ▶ Anno = dal ... al ...
		▶ Anno = dal ...

KEY		Cap code with key ▶ Year = up to ...
		Cap code without key ▶ Year = from ... up to ...
		▶ Year = from ...



ELENCO MARCHE E MODELLI DI VETTURA - CAR MAKES AND MODELS

MARCA E TIPO DI VETTURA CAR MAKES / MODELS		 FARMA	 NUOVA FAAB	MARCA E TIPO DI VETTURA CAR MAKES / MODELS		 FARMA	 NUOVA FAAB
<i>Prosegue - Continued</i> VOLVO				WARTBURG			
Autocarri con p.t.t. oltre 3,5T (cabinati a 3 e a 4 assi): Trucks with capacity over 3,5T (cabin cruisers with 3 and 4 axis): FM-260 6x2 - FM-300 6x2 - FM-340 6x2 - FM-380 6x2 - FM-400 6x2 - FM-440 6x2 - FM-480 6x2 - FM-400 8x2 - FH-440 8x2 - FH-480 8x2 - FH-500 6x2 - FH16-550 6x2 - FH16-610 6x2 - FH-400 8x2 - FH-440 8x2 - FH-480 8x2 - FH-520 8x2		019858	025428	0HH507	President 1000 - Wartburg	015310	0BZ369
Autocarri con p.t.t. 3,5T (trattori a 2 assi): Trucks with capacity over 3,5T (tractors with 2 axis): FM-380 - FM-400 - FM-440 - FM-480 - FH-400 - FH-440 - FH-480 - FH-520 - FH16-550 - FH16-610		019858	025428	0HH507	Tourist Break	015311	0BD459
Autocarri con p.t.t. 3,5T (trattori a 3 assi): Trucks with capacity over 3,5T (tractors with 3 axis): FH-400 Pusher 6x2 - FH-440 Pusher 6x2 - FH-480 Pusher 6x2 - FH-520 Pusher 6x2 - FH-400 6x4 - FH-440 6x4 - FH-480 6x4 - FH-520 6x4		019858	025428	0HH507	WOLSELEY		
FE - FH - FM - FMX Diesel tank Euro6		019858	025428	0HH507	Hornet	015310	0BZ369
FL Diesel tank Euro6	13 ▶	067957		0QD637	YALTA		
C30	12/06 ▶ 6/13	067802	023354	0QD656	De Luxe - Yalta	015310	0BZ369
C70 Coupé, Cabriolèt		067754	023334	0QD449	YETI		
S40	▶ 12/09	067754	023334	0QD449	Yem 903	067749	023349
S40	01/10 ▶	067754	023334	0QD449	ZAPOROSETE		
S40 T4	9/97 ▶	067754	023334	0QD449	Zaporosete	015310	0BZ369
S70		067754	023334	0QD449	ZASTAVA		
S60	1/01 ▶	067754	023334	0QD449	101 - 125 Pz, Pz Special	067749	023349
S80	7/98 ▶ 7/16	067754	023334	0QD449	750	067702	023201
V40	9/97 ▶ 04	067754	023334	0QD449	ZAZ		
V50	03/04 ▶	067802	023354	0QD656	966 L	015310	0BZ369
V60	11/10 ▶	067754	023334	0QD449			
V70	▶ 8/16	067754	023334	0QD449			
XC60	07/08 ▶ 5/17	067754	023334	0QD449			
XC60 (for automatic filler neck)	5/17 ▶	000850					
XC70	9/02 ▶ 8/16	067754	023334	0QD449			
XC90	10/02 ▶ 12/14	067754	023334	0QD449			
XC90 (for automatic filler neck)	01/15 ▶	000850					
Serbatoio AdBlue non ventilato AdBlue non vented tank		065548	025444				

LEGENDA

 Codice tappo con chiave ▶ Anno = fino al ...
 Anno ▶ Anno = dal...al...
 Codice tappo senza chiave Anno ▶ = dal ...

KEY





 Cap code with key ▶ Year = up to ...
 Year ▶ Year = from...up to...
 Cap code without key Year ▶ = from ...

**TAPPI ECO CONFORMI
ALLE NORMATIVE EUROPEE**







***ECO CAPS CONFORM
TO EU NORMS***

APPLICABILITA' SPECIFICHE PER OGNI TAPPO
DESCRIPTIVE APPLICATIONS





APPLICABILITA' SPECIFICHE DI OGNI TAPPO - APPLICATION BY CODE

<p>CODICE TAPPO CON CHIAVE E SENZA CHIAVE CAP CODE WITH AND WITHOUT KEY</p>		<p>CODICE TAPPO CON CHIAVE E SENZA CHIAVE CAP CODE WITH AND WITHOUT KEY</p>	
<p>012300 - 0AZ380</p> <p>Tappo con chiave ø72 con ghiera ø35,5 (2 denti) per bocch. a baionetta esterna ø63 (3 denti), ventilato Locking cap ø72 with adaptor ø35,5 (2-lug) for filler neck ø63 (3-lug), vented</p>  <p>PEUGEOT 404 504 505 (escluso Break excluded) ▶ 84 604 ▶ 11/76 J7 ▶ 69 J9 ▶ 69</p>		<p><i>Prosegue - Continued</i> 012302</p> <p>MG (British-Leyland) 1100 1300 MK2</p> <p>MORRIS (British-Leyland) 1100 MK II, Van Pick-Up 1300 Automatic - Traveller</p>	
<p>012302 - 0AZ381</p> <p>Tappo con chiave ø72 con ghiera ø35,5 (2 denti) per bocch. a baionetta esterna ø57 (2 denti), ventilato Locking cap ø72 with adaptor ø35,5 (2-lug) for filler neck ø57 (2-lug), vented</p>  <p>AUSTIN 1100 - 1300</p> <p>BEDFORD Calva CF Autocarro (truck) 130N, 160N, 180N, TKE serie EJM CF Camioncino (small lorry) 100N - 170N</p> <p>CITROËN Acadiane - Ami 6 - Ami 8 Break - AK Azu - AZ Enac - HY Betaillere Mehari 2 CV - 2 HP6 - 3 CV</p> <p><i>Continua - To be continued</i></p>		<p>012307 - 0AZ395</p> <p>Tappo con chiave ø72 con ghiera ø35,5 (2 denti) per bocch. a baionetta esterna ø64 (2 denti), ventilato Locking cap ø72 with adaptor ø35,5 (2-lug) for filler neck ø64 (2-lug), vented</p>  <p>PEUGEOT 505, Break ▶ 84</p>	
<p>LEGEND</p> <p>▶ Anno = fino al ... Anno ▶ Anno = dal...al... Anno ▶ = dal ...</p>	<p>KEY</p> <p>▶ Year = up to ... Year ▶ Year = from...up to... Year ▶ = from ...</p>		

APPLICABILITA' SPECIFICHE DI OGNI TAPPO - APPLICATION BY CODE

<p>CODICE TAPPO CON CHIAVE E SENZA CHIAVE CAP CODE WITH AND WITHOUT KEY</p>		<p>CODICE TAPPO CON CHIAVE E SENZA CHIAVE CAP CODE WITH AND WITHOUT KEY</p>	
<p>012308 - 0AD478 Tappo con chiave ø64 con ghiera per bocch. a tubo da ø38 a ø47, ventilato Locking cap ø64 with adaptor for tube type filler neck from ø38 to ø47, vented</p>  <p>PIAGGIO Ape P50 serbatoio in metallo (metal tank)</p>		<p>012510 - 0AZ382 Tappo con chiave ø90 con ghiera ø35,5 (2 denti) per bocch. a baionetta esterna ø64 (2 denti), ventilato Locking cap ø87 with adaptor ø35,5 (2-lug) for filler neck ø64 (2-lug), vented</p>  <p>PEUGEOT 104 305</p> <p>TALBOT Samba</p>	<p>80 ▶ 80 ▶ 83 ▶</p>
<p>012312 - 0AD489 Tappo con chiave ø48.5 con ghiera ø25,5 per bocch. a tubo di ø38, ventilato Locking cap ø48.5 with adaptor ø25,5 for tube type filler neck ø38, vented</p>  <p>PIAGGIO Ape P50 serbatoio in plastica (plastic tank)</p>	<p>6/06 ▶ 2/11</p>	<p>015303 - OBD451 025207 Tappo ø72 a baionetta interna ø33,5 x ø40,5 x 5,5, non ventilato Cap ø72 inside bayonet ø33,5 x ø40,5 x 5,5, non vented</p>   <p>DATSUN Cherry F11, 100 A Cherry 120 Y e Coupé</p> <p>OPEL Ascona III Corsa 5 porte (5 door) Rekord 2,3 D, TD, 2,2 i Senator - Monza</p>	<p>81 ▶ 84 ▶ 90 83 ▶ 84 ▶</p>
<p>LEGEND</p> <p>▶ Anno = fino al ... Anno ▶ Anno = dal...al... Anno ▶ = dal ...</p>	<p>KEY</p> <p>▶ Year = up to ... Year ▶ Year = from...up to.. Year ▶ = from ...</p>		

APPLICABILITA' SPECIFICHE DI OGNI TAPPO - APPLICATION BY CODE

CODICE TAPPO CON CHIAVE E SENZA CHIAVE CAP CODE WITH AND WITHOUT KEY		
015306 - OBZ378 025232		
<p>Tappo ø72 a baionetta interna ø35 x ø42,5 x 8,5, ventilato Cap ø72 inside bayonet ø35 x ø42,5 x 8,5, vented</p> 		
<p>ARO DACIA 240 - 241 - 242 - 243 - 244</p> <p>DACIA 1304 - 1310</p> <p>JAGUAR (British-Leyland) Daimler Double six V12 Sovereign</p> <p>RENAULT 16 18 20 30 4 - 6 - 7 - 8 - 10 - 12 - 12L, TL, TR, TS 5 Cargo Dauphine Espac Estafette Fuego Furgonette Gordini Master Ondine Super Galion - SG 2 - SG 4 Super Goelette Trafic, Trafic Cam. (small lorry)</p>	<p>▶ 9/81 77 ▶ 77 ▶ ▶ 84 ▶ 91 ▶ 9/81 ▶ 98</p>	
015308 - 00D097		
<p>Tappo con chiave ø72 per bocch. a baionetta interna ø39, ventilato Locking cap ø72 for inside bayonet filler neck ø39, vented</p> 		
<p>PIAGGIO Ape MP - MP 500 - MP 600 Ape MPV - TM - Diesel</p>		
015310 - OBZ369		
<p>Tappo con chiave ø72 per bocch. a baionetta interna ø39, ventilato Locking cap ø72 for inside bayonet filler neck ø39, vented</p> 		
<p>ALFA ROMEO 1750 A11 - A12 - F11 - F12 Alfetta GT 1.8 Giulia, GT, Diesel Junior Z 1300</p>		▶ 82
<p>AMERICAN MOTORS Matador</p>		
<p>ARO DACIA M461 C</p>		

Continua - To be continued



LEGEN

▶ Anno = fino al ...
Anno ▶ Anno = dal...al...
Anno ▶ = dal ...

KEY

▶ Year = up to ...
Year ▶ Year = from..up to..
Year ▶ = from ...

APPLICABILITA' SPECIFICHE DI OGNI TAPPO - APPLICATION BY CODE

CODICE TAPPO CON CHIAVE E SENZA CHIAVE CAP CODE WITH AND WITHOUT KEY		CODICE TAPPO CON CHIAVE E SENZA CHIAVE CAP CODE WITH AND WITHOUT KEY	
<i>Prosegue - Continued</i> 015310		<i>Prosegue - Continued</i> 015310	
AUDI 60 L ▶ 69 75 Variant ▶ 69 90 Super Autounion 1000 KG DKW Furgon F 102 Sureleve Verhoogte AUSTIN A 40 Allegro - Allegro 2 Combi MK 2 Cooper S Mini Clubman Estate Mini Minor - Traveller Oxford BMW 1800 2000 CA, CS, T, Ti Lux 2500 2800 Glass 3000 , 3.0 , 3.3 L DAF 600 - 750 Daffodil de luxe extra 33, 44, 46, 55, 66 DAIMLER (British-Leyland) Daimler V8 - Sovereich FEDERAL Federal FERGUSON Massey Ferguson FE 35 Mod. 65 FORD 17 M - 17 MSW 20 MXL, Coupé, Hardtop 26 M Capri II - 1300 GL - 1600 S e Ghia Consul 1700 L, 2000 L Granada 1,9 Diesel Granada 1700 Granada 2.0 , 2.3, 2.6 , 2.8 , 3.0 Taunus 1300 - 1600 - 2000 ▶ 80 Taunus 17 M - 17 M Super Taunus 20 M, 20 MTS Coupé GAZ (Volga) GAZ 69 AM		GLASS GOGGOMOBIL ISARD 1004 1304 GL e GT GOLIATH Hansa 1100 Goli Transporter 1100 GUTBROD Model Superior Atlas HANOMAG F20 - F25 - F30 - F35 - F45 - F55 - F 65 - F66 - F75 - F76 - F85 Hanomag Henschel, Matador INNOCENTI (British-Leyland) A40 Mini 90, 120 Mini Minor T Regent INNOCENTI (Nuova) 650 De Tomaso Mille - Mini 90 - 3 Cilindri INTERNATIONAL D 1300 - D 1500 1300 - 1600 - 1602P - 1604 - 1800 - 1804 JAGUAR (British-Leyland) E Type 4,2 JOHN DEERE 435 530 630 LEYLAND Sherpa Camioncino (small lorry) MASSEY FERGUSON Mod. 65 MERCEDES 180 - 190 - 220 ▶ 68 206 Furgone (van) 306, 407, 508, 608 Furgone (van) MG (British-Leyland) MG Midget MK III MGB GT, Hardtop MINI (British-Leyland) Estate ▶ 9/01 850 ▶ 9/01 1275 GT ▶ 9/01	
<i>Continua - To be continued</i>		<i>Continua - To be continued</i>	



LEGEN

 ▶ Anno = fino al ...
 Anno ▶ Anno = dal...al...
 Anno ▶ = dal ...

KEY

 ▶ Year = up to ...
 Year ▶ Year = from...up to..
 Year ▶ = from ...

APPLICABILITA' SPECIFICHE DI OGNI TAPPO - APPLICATION BY CODE

<p>CODICE TAPPO CON CHIAVE E SENZA CHIAVE CAP CODE WITH AND WITHOUT KEY</p>		<p>CODICE TAPPO CON CHIAVE E SENZA CHIAVE CAP CODE WITH AND WITHOUT KEY</p>	
<p><i>Prosegue - Continued</i> 015310</p> <p>MORRIS (British-Leyland) Mini Clubman Estate - Combi Mini 850 - 1275 GT Morris Cooper - Morris 850</p> <p>MOSKVITCH 2137 Station Wagon 2140 412 427 Moskvitch Moskvitch 1500 e Famil.</p> <p>NSU Prinz 4, 4 L 1000 L - 1000 S - 1000 TI 1200 C</p> <p>OPEL Olimpia 1,2 - 1,5 Kapitan Blitz</p> <p>SCALDIA 1300 N</p> <p>SEDDON 18/DD6/400</p> <p>TEMPO Matador Rapid-Viking</p> <p>VOLKSWAGEN K 70</p> <p>VOLVO 66</p> <p>WARTBURG President 1000 Wartburg</p> <p>WOLSELEY Hornet</p> <p>YALTA De Luxe Yaltan</p> <p>ZAPOROSETE Zaporosete</p> <p>ZAZ 966L</p>		<p>015311 - OBD459</p> <p>Tappo con chiave ø72 a baionetta interna ø37,4 x ø46 x 9, non ventilato Cap senza chiave ø72 inside bayonet ø37,4 x ø46 x 9, non vented</p> <div data-bbox="906 450 1257 734" data-label="Image"> </div> <p>AUDI 100 GL, GL Aut. ▶ 73</p> <p>AUSTIN Cooper SMK2 Maxi - 1500 Mini Cooper S, MK2 Mini Cooper 1000, SDL, 1001, 1003</p> <p>BMW 1500</p> <p>BROSSEL Brossel</p> <p>FIAT 127 Diesel ▶ 82 127 Fiorino Pick-Up 127 Rustica 147 Brasile</p> <p>FORD Zodiac Zephir</p> <p>GLASS GOGGOMOBIL ISARD 1304 TS Normal</p> <p>INNOCENTI (British-Leyland) Mini 1000 Mini Cooper MK2, MK3, 1300 Mini Minor 1001, Export, 1003 Mini Minor, MK2, MK3 Minimatic</p> <p>JAGUAR (British-Leyland) E type V12 Coupé (3 s.) E type V12 Spider (3 s.) E type VL 2, 3.4, 3.8 S Jaguar XJS</p> <p>MERCEDES 190 - 200</p>	<p>69 ▶ 84</p>

Continua - To be continued





LEGEN

▶ Anno = fino al ...
Anno ▶ Anno = dal...al...
Anno ▶ = dal ...

KEY

▶ Year = up to ...
Year ▶ Year = from...up to...
Year ▶ = from ...

APPLICABILITA' SPECIFICHE DI OGNI TAPPO - APPLICATION BY CODE

CODICE TAPPO CON CHIAVE E SENZA CHIAVE CAP CODE WITH AND WITHOUT KEY			CODICE TAPPO CON CHIAVE E SENZA CHIAVE CAP CODE WITH AND WITHOUT KEY		
015319 - 0BZ359	025207		015324 - 0BD455	025232	
Tappo ø72 a baionetta interna ø33,5 x ø40,5 x 5,5, non ventilato Cap ø72 inside bayonet ø33,5 x ø40,5 x 5,5, non vented			Tappo ø72 a baionetta interna ø35 x ø42 x 10, ventilato Cap ø72 inside bayonet ø35 x ø42 x 10, vented		
					
AUDI			FORD		
100 Avant 5E	73 ▶ 80		Kurier	81 ▶	
100 Avant L, GL, LS, GLS	73 ▶ 80				
100 LS Coupé	72 ▶		MAZDA		
50			323	▶ 79	
INNOCENTI (Nuova)			818	▶ 77	
Porter			929	▶ 73	
PIAGGIO			Light Van	81	
Porter			MITSUBISHI		
VOLKSWAGEN			Colt - Galant	81 ▶	
Derby			Light Van	81 ▶	
Maggiolone (Beetle)	68 ▶ 73		Space Wagon	▶ 91	
Passat	▶ 76				
Passat Diesel	▶ 81				
Polo - Polo II	▶ 11/94				





LEGEN

▶ Anno = fino al ...
Anno ▶ Anno = dal...al...
Anno ▶ = dal ...

KEY

▶ Year = up to ...
Year ▶ Year = from..up to..
Year ▶ = from ...

APPLICABILITA' SPECIFICHE DI OGNI TAPPO - APPLICATION BY CODE

CODICE TAPPO CON CHIAVE E SENZA CHIAVE CAP CODE WITH AND WITHOUT KEY			CODICE TAPPO CON CHIAVE E SENZA CHIAVE CAP CODE WITH AND WITHOUT KEY		
015330 - OBD458			015342 - OBZ361		
025206			025206		
Tappo ø72 per bocch. a baionetta interna ø35, ventilato Cap ø72 for inside bayonet filler neck ø35, vented			Tappo ø72 per bocch. a baionetta interna ø35, ventilato Cap ø72 for inside bayonet filler neck ø35, vented		
					
NISSAN Patrol - King Cab - Terrano - Vanette			AUDI 80		69 ▶ 72
SUBARU Subaru			AUTOBIANCHI Primula		
015338 - OBZ363			DATSUN 1000 De Luxe		
Tappo con chiave ø72 per bocch. a baionetta interna ø40, ventilato Locking cap ø72 for inside bayonet filler neck ø40, vented			FIAT 1100 D, H, Special - 1100/58 1100 R Familiare (estate)		▶ 67
			JEEP CJ5 Cherokee CJ7 Renegade, Laredo		▶ 2/96
HONDA Accord Civic - CRX Concerto Prelude		76 ▶ 90 76 ▶ 94 76 ▶ 94 76 ▶ 94	TOYOTA Carina 1600 - Celica 1600 Corolla 1200 Corolla S.W. Corona MKI, MKII, SKII Station Wagon Land Cruiser - Osaka		71 ▶ 76 ▶ 76 ▶ 1/02 ▶ 79
MG ZR		1/02 ▶			







LEGEND

▶ Anno = fino al ...
Anno ▶ Anno = dal...al...
Anno ▶ = dal ...

KEY

▶ Year = up to ...
Year ▶ Year = from..up to..
Year ▶ = from ...

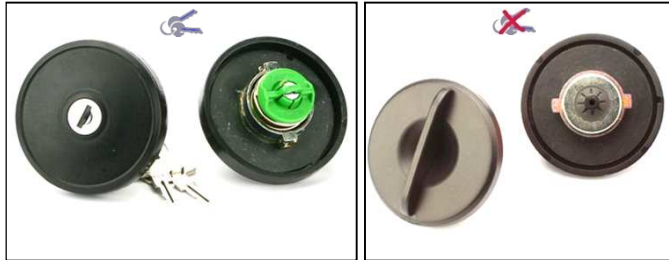
APPLICABILITA' SPECIFICHE DI OGNI TAPPO - APPLICATION BY CODE

CODICE TAPPO CON CHIAVE E SENZA CHIAVE CAP CODE WITH AND WITHOUT KEY			CODICE TAPPO CON CHIAVE E SENZA CHIAVE CAP CODE WITH AND WITHOUT KEY		
015345 - OBZ385			015359 - OBD517		
Tappo ø72 a baionetta interna ø35 x ø42,5 x 8,5, non ventilato Cap ø72 inside bayonet ø35 x ø42,5 x 8,5, non vented			Tappo con chiave ø66 per bocch. a baionetta interna ø40, non ventilato Locking cap ø66 for inside bayonet filler neck ø40, non vented		
					
RENAULT 18 Break 21 Fuego Turbo Renault 9, 11, 25		10/81 ▶ ▶ 92 10/81 ▶	N.B. : per applicare il tappo ruotare la chiave in senso antiorario N.B. : to lock, turn key anti-clockwise		
			FORD Courier Escort Berl. e Sw. Escort Furgone (van) Fiesta Orion Berl. e Sw. Orion Furgone (van)		9/91 ▶ 1/94 90 ▶ 92 ▶ 92 89 ▶ 94 90 ▶ 92
015354 - OBZ360			015361		
Tappo ø72 a baionetta interna ø33,5 x ø40 x 7, ventilato Cap ø72 inside bayonet ø33,5 x ø40 x 7, vented			Tappo con chiave ø72 per bocch. a baionetta interna ø35, non ventilato Locking cap ø72 for inside bayonet filler neck ø35, non vented		
					
SUZUKI Jeep Samurai SJ 413 JX - SJ 410 JX			BEDFORD Midi		89 ▶
			SUZUKI Carry		







LEGEN

▶ Anno = fino al ...
Anno ▶ Anno = dal...al...
Anno ▶ = dal ...

KEY

▶ Year = up to ...
Year ▶ Year = from..up to..
Year ▶ = from ...

APPLICABILITA' SPECIFICHE DI OGNI TAPPO - APPLICATION BY CODE

CODICE TAPPO CON CHIAVE E SENZA CHIAVE CAP CODE WITH AND WITHOUT KEY			CODICE TAPPO CON CHIAVE E SENZA CHIAVE CAP CODE WITH AND WITHOUT KEY		
015363 - OBD527 025217			015371 - OBD585 025207		
Tappo ø72 per bocch. a baionetta interna ø40 (3 denti), non ventilato Cap ø72 for inside bayonet filler neck ø40 (3 teeth), non vented			Tappo ø72 a baionetta interna ø33,5 x ø40,5 x 5,5, non ventilato Cap ø72 inside bayonet ø33,5 x ø40,5 x 5,5, non vented		
					
FORD Galaxy 1.9, 2.0, 2.8 ▶ 8/06 SEAT Alhambra 96 ▶ 10/10 VOLKSWAGEN Caravelle 12/95 ▶ 01 Multivan ▶ 01 Sharan 00 ▶ 10/10 Transporter 90 ▶ 01			OPEL Frontera 91 ▶ 5/95		
015365 - OBD569			015373 - OBD605 025209		
Tappo con chiave ø60 per bocch. a baionetta interna ø40, non ventilato Locking cap ø60 for inside bayonet filler neck ø40, non vented			Tappo ø72 a baionetta interna ø33,5 x ø40 x 7, non ventilato Cap ø72 inside bayonet ø33,5 x ø40 x 7, non vented		
					
N.B. : per applicare il tappo ruotare la chiave in senso antiorario N.B. : to lock, turn key anti-clockwise			OPEL Frontera 5/95 ▶ 98		
FORD Courier 2/94 ▶ 95 Escort Berl. e Sw. 1/93 ▶ 8/01 Escort Cabriolet 95 ▶ Escort furgoni (van) 1/95 ▶ Fiesta 94 ▶ 10/95 Fiesta van ▶ 9/08 Orion Berl. e Sw. 1/93 ▶ Partner Transit 1/92 ▶ 9/94					





LEGEN

▶ Anno = fino al ...
Anno ▶ Anno = dal...al...
Anno ▶ = dal ...

KEY

▶ Year = up to ...
Year ▶ Year = from..up to..
Year ▶ = from ...

APPLICABILITA' SPECIFICHE DI OGNI TAPPO - APPLICATION BY CODE

CODICE TAPPO CON CHIAVE E SENZA CHIAVE CAP CODE WITH AND WITHOUT KEY			CODICE TAPPO CON CHIAVE E SENZA CHIAVE CAP CODE WITH AND WITHOUT KEY		
015375 - 0BD626			015377 - 0BD627		025251
Tappo con chiave ø72 per bocch. a baionetta interna ø39, non ventilato Locking cap ø72 for inside bayonet filler neck ø39, non vented			Tappo ø72 per bocch. a baionetta interna ø47, non ventilato Cap ø72 for inside bayonet filler neck ø47, non vented		
					
CITROËN			DACIA		
C5	4/01 ▶ 3/04		Dokker		1/13 ▶
Xsara - Xsara Diesel	10/98 ▶		Duster		6/10 ▶
			Lodgy		10/13 ▶
LANCIA			Logan		2/06 ▶
Z	99 ▶		Logan sw		3/07 ▶
			Sandero		6/08 ▶
			MERCEDES		
			Citan		12 ▶
			OPEL		
			Movano		99 ▶
			Movano Telaio		
			Vivaro		06 ▶
			NISSAN		
			Interstar		01 ▶
			NV300		17 ▶
			NV400		11 ▶
			RENAULT		
			Capture		6/13 ▶
			Clio		3/98 ▶
			Clio S.W.		2/09 ▶
			Clio Van		3/98 ▶
			Espace		2/98 ▶ 11/02
			Kangoo		08 ▶
			Kangoo Express		08 ▶
			Laguna Berlina, S.W.		99 ▶ 10/07
			Master		99 ▶
			Mégane		3/96 ▶ 12/02
			Modus		11/04 ▶
			Scénic benz e diesel		▶ 6/03
			Trafic		7/07 ▶
			Twingo		
			Wind		9/10 ▶



LEGEND

▶ Anno = fino al ...
Anno ▶ Anno = dal...al...
Anno ▶ = dal ...

KEY

▶ Year = up to ...
Year ▶ Year = from...up to..
Year ▶ = from ...

APPLICABILITA' SPECIFICHE DI OGNI TAPPO - APPLICATION BY CODE

CODICE TAPPO CON CHIAVE E SENZA CHIAVE CAP CODE WITH AND WITHOUT KEY			CODICE TAPPO CON CHIAVE E SENZA CHIAVE CAP CODE WITH AND WITHOUT KEY					
015379 - 0BD647			015379 - 025245					
<p>Tappo ø72 a baionetta interna ø38 x ø45 x 31, non ventilato Cap ø72 inside bayonet ø38 x ø45 x 31, non vented</p> 			<p><i>Prosegue - Continued</i></p> 					
<p>CITROËN</p> <p>Berlingo Benz. (petrol) 4/08 ▶ 5/12</p> <p>Berlingo 5/12 ▶</p> <p>C2 Benz. (petrol) 10/03 ▶ 12/09</p> <p>C3 Benz. (petrol) 5/02 ▶ 12/10</p> <p>C3 11/09 ▶</p> <p>C3 Aircross 11/17 ▶</p> <p>C3 Picasso 1/09 ▶</p> <p>C3 Pluriel Benz. (petrol) 7/03 ▶ 7/10</p> <p>C4 Benz. (petrol) escluso multispazio excluded 12/04 ▶ 8/10</p> <p>C4 Aircross 4/12 ▶ 2/17</p> <p>C4 Cactus 7/14 ▶</p> <p>C5 Benz. (petrol) Berlina, SW 5/08 ▶</p> <p>C8 Benz. (petrol) 11/02 ▶</p> <p>C-Crosser Benz. (petrol) 8/07 ▶ 2/12</p> <p>C-Elysee 5/16 ▶</p> <p>DS3 2/10 ▶</p> <p>DS5 1/12 ▶</p> <p>Jumpy Benz. (petrol) 5/07 ▶</p> <p>FIAT</p> <p>Scudo Benz. (petrol) 2/07 ▶</p> <p>Ulysse Benz. (petrol) 7/02 ▶ 11/10</p> <p>LANCIA</p> <p>Phedra Benz. (petrol) 8/02 ▶ 2/10</p> <p>MITSUBISHI</p> <p>ASX 8/15 ▶</p> <p>OPEL</p> <p>Crossland X 7/17 ▶</p> <p>Grandland X 9/17 ▶</p> <p>PEUGEOT</p> <p>207 Benz. (petrol) 5/06 ▶</p> <p>207 3/12 ▶</p> <p>208 3/12 ▶</p> <p>307 Benz. (petrol) 6/01 ▶</p> <p>308 10/07 ▶</p> <p>508 3/11 ▶</p> <p>807 Benz. (petrol) 11/02 ▶ 10/13</p> <p>1007 Benz. (petrol) 5/05 ▶ 2/11</p>			<p>2008 5/13 ▶</p> <p>3008 7/09 ▶</p> <p>4007 8/07 ▶ 12/13</p> <p>5008 12/09 ▶</p> <p>Expert Benz. (petrol) 2/07 ▶</p> <p>5008 12/09 ▶</p> <p>Expert Benz. (petrol) 2/07 ▶</p> <p>Partner Benz. (petrol) 08 ▶</p> <p>Partner Tepee Benz. (petrol) 7/08 ▶</p> <p>RCZ 10 ▶ 8/15</p> <p>Traveller 16 ▶</p>					
015381 - 0BD648			015381 - 025247					
<p>Tappo ø72 a baionetta interna ø38 x ø45 x 31, non ventilato Cap ø72 inside bayonet ø38 x ø45 x 31, non vented</p> 			<p>CITROËN</p> <p>Berlingo Diesel 4/08 ▶ 5/12</p> <p>C2 Diesel 10/03 ▶ 12/09</p> <p>C3 Diesel 5/02 ▶ 12/10</p> <p>C3 Pluriel Diesel 7/03 ▶ 7/10</p> <p>C4 Diesel escluso multispazio excluded 12/04 ▶ 8/10</p> <p>C5 Diesel Berlina, SW 11/02 ▶</p> <p>C8 Diesel 11/02 ▶</p> <p>C-Crosser Diesel 8/07 ▶ 2/12</p> <p>Jumpy Diesel 5/07 ▶</p> <p>FIAT</p> <p>Scudo Diesel 2/07 ▶</p> <p>Ulysse Diesel 7/02 ▶ 11/10</p> <p>LANCIA</p> <p>Phedra Diesel 8/02 ▶ 2/10</p> <p>PEUGEOT</p> <p>207 Diesel 5/06 ▶</p> <p>307 Diesel 6/01 ▶</p> <p>807 Diesel 11/02 ▶ 10/13</p> <p>1007 Diesel 5/05 ▶ 2/11</p> <p>Expert Diesel 2/07 ▶</p> <p>Partner Diesel 08 ▶</p> <p>Partner Tepee Diesel 7/08 ▶</p>			<p>Calamita Magnet</p>		

Continua - To be continued

LEGEND

▶ Anno = fino al ...
Anno ▶ Anno = dal...al...
Anno ▶ = dal ...

KEY

▶ Year = up to ...
Year ▶ Year = from...up to...
Year ▶ = from ...

APPLICABILITA' SPECIFICHE DI OGNI TAPPO - APPLICATION BY CODE

CODICE TAPPO CON CHIAVE E SENZA CHIAVE CAP CODE WITH AND WITHOUT KEY			CODICE TAPPO CON CHIAVE E SENZA CHIAVE CAP CODE WITH AND WITHOUT KEY		
015383 - OBD649	025249		015506 - OBZ368	025232	
Tappo ø72 a baionetta interna ø35,5 x ø45 x 18,5, non ventilato Cap ø72 inside bayonet ø38 x ø45 x 18,5, non vented			Tappo ø98 a baionetta interna ø35 x ø42,5 x 10, ventilato Cap ø98 inside bayonet ø35 x ø42,5 x 10, vented		
PEUGEOT			DACIA		
407	5/04 ▶ 10/11		1310 Break		
407 S.W.	9/04 ▶ 10/11				
407 Coupè	12/05 ▶ 4/12		RENAULT		
CITROEN			12 Break		
C5	11/04 ▶ 4/08		14	▶ 77	
C6	1/06 ▶		15 - 17		
MITSUBISHI			177		
Outlander	3/07 ▶ 12/12		20 - 30	▶ 77	
SMART			Express	▶ 91	
Fortwo	10/14 ▶				
015505 - OBD464	025209				
Tappo ø95 a baionetta interna ø35,5 x 40,5 x 9, non ventilato Cap ø95 inside bayonet ø35,5 x ø40,5 x 9, non vented					
VOLVO					
142 - 144 - 145 - 164 - 242 - 244		▶ 77			
264		▶ 77			





LEGEN

▶ Anno = fino al ...
Anno ▶ Anno = dal...al...
Anno ▶ = dal ...

KEY

▶ Year = up to ...
Year ▶ Year = from..up to..
Year ▶ = from ...

APPLICABILITA' SPECIFICHE DI OGNI TAPPO - APPLICATION BY CODE

CODICE TAPPO CON CHIAVE E SENZA CHIAVE CAP CODE WITH AND WITHOUT KEY		
015509 - OBD465	025219	
Tappo ø98 a baionetta interna ø38,5 x ø46 x 7,5, non ventilato Cap ø98 inside bayonet ø38,5 x ø46 x 7,5, non vented		
		
FORD		
Break Super Cortina		
Cortina De Luxe - Cortina MK 2		
Cortina GT	66 ▶ 68	
Escort Familiare	▶ 80	
Taurus 17 M e 20 M Combi Turnier		
MERCEDES		
207, 307 Furgone (van)		
608 Furgone (van)	79 ▶	
OPEL		
Ascona	▶ 76	
Commodore GS/E 2800		
Manta	▶ 76	
Rekord 1.9, 2000, 2100		
VOLKSWAGEN		
Caravelle	80 ▶	
Furgone (van) Bus-Joker	80 ▶	
015514 - OBD467		025206
Tappo ø93,5 a baionetta interna ø33,5 x ø40,5 x 5,5, ventilato Cap ø93,5 inside bayonet ø33,5 x ø40,5 x 5,5, vented		
		
VOLKSWAGEN		
Golf (fino al telaio / up to frame n°1783187614)		
Scirocco (fino al telaio / up to frame n°5382040975)		▶ 78
Scirocco GT		
015515 - OBD370		025207
Tappo ø85 a baionetta interna ø33,5 x ø40,5 x 5,5, non ventilato Cap ø85 inside bayonet ø33,5 x ø40,5 x 5,5, non vented		
		
VOLKSWAGEN		
Golf Diesel		▶ 83
Golf GTI	81 ▶ 83	
Golf GL (dal telaio / from frame n°1783187615)	78 ▶ 83	
Scirocco (dal telaio / from frame n°5382040976)	78 ▶	
Jetta (solo per serbatoi areati - for vented tanks only)		▶ 83

LEGEN

▶ Anno = fino al ...
Anno ▶ Anno = dal...al...
Anno ▶ = dal ...







KEY

▶ Year = up to ...
Year ▶ Year = from..up to..
Year ▶ = from ...

APPLICABILITA' SPECIFICHE DI OGNI TAPPO - APPLICATION BY CODE

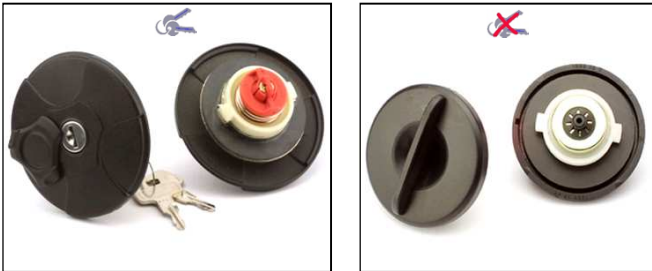
CODICE TAPPO CON CHIAVE E SENZA CHIAVE CAP CODE WITH AND WITHOUT KEY			CODICE TAPPO CON CHIAVE E SENZA CHIAVE CAP CODE WITH AND WITHOUT KEY		
015531 - OBZ427 025219			015539 - OBZ383 025207		
Tappo ø90 a baionetta interna ø38,5 x ø46 x 7,5, non ventilato Cap ø90 inside bayonet ø38,5 x ø46 x 7,5, non vented			Tappo ø98 a baionetta interna ø33,5 x ø40,5 x 5,5, non ventilato Cap ø98 inside bayonet ø33,5 x ø40,5 x 5,5, non vented		
CITROËN Axel C15D Furgone (van) Pick Up		5/95 ▶ 5/95 ▶	OPEL Astra Cabriolet Combo 1.7 D Corsa 3 porte (3 door) Kadett serie D - E Kadett serie GSI		▶ 10/94 ▶ 11/94 80 ▶ 85 ▶
015536 - OBZ403 025238			015556 - OBD470 025228		
Tappo ø87 a baionetta interna ø46,5 x ø53,9 x 11, ventilato Cap ø87 inside bayonet ø46,5 x ø53,9 x 11, vented			Tappo ø82 a baionetta interna ø33,5 x ø40 x 7, ventilato Cap ø82 inside bayonet ø33,5 x ø40 x 7, vented		
FORD Furgoni (vans) serie A - H Transit 100, 130, 160, 190		▶ 86 ▶ 86	FORD Transit		86 ▶ 88
NISSAN Cabstar (NT400)		08 ▶			
LEGEND ▶ Anno = fino al ... Anno ▶ Anno = dal...al... Anno ▶ = dal ...			KEY ▶ Year = up to ... Year ▶ Year = from..up to.. Year ▶ = from ...		

APPLICABILITA' SPECIFICHE DI OGNI TAPPO - APPLICATION BY CODE

CODICE TAPPO CON CHIAVE E SENZA CHIAVE CAP CODE WITH AND WITHOUT KEY			CODICE TAPPO CON CHIAVE E SENZA CHIAVE CAP CODE WITH AND WITHOUT KEY		
015559 - 0BZ445			015563 - 0BD552		
Tappo ø90 a baionetta interna ø40 x ø47,5 x 9,5, non ventilato Cap ø90 inside bayonet ø40 x ø47,5 x 9,5, non vented			Tappo ø109 a baionetta interna ø40 x ø47,5 x 9,5, non ventilato Cap ø109 inside bayonet ø40 x ø47,5 x 9,5, non vented		
					
CITROËN Ax			CITROËN Saxo		
			PEUGEOT 106, Rallye		
015561 - 0BD519			015567 - 0BD604		
Tappo con chiave ø82 a baionetta interna ø38,5 x ø46 x 10, non ventilato Locking cap ø82 inside bayonet ø38,5 x ø46 x 10, non vented			Tappo con chiave ø speciale per bocch. a baionetta interna ø40, non ventilato Locking cap ø specific for inside bayonet filler neck ø40, non vented		
					
N.B. : per applicare il tappo ruotare la chiave in senso antiorario N.B. : to lock, turn key anti-clockwise			N.B. : per applicare il tappo ruotare la chiave in senso antiorario N.B. : to lock, turn key anti-clockwise		
FORD Transit		89 ▶ 12/91	FORD Transit		10/94 ▶ 1/00





LEGEN

▶ Anno = fino al ...
Anno ▶ Anno = dal...al...
Anno ▶ = dal ...

KEY

▶ Year = up to ...
Year ▶ Year = from..up to..
Year ▶ = from ...

APPLICABILITA' SPECIFICHE DI OGNI TAPPO - APPLICATION BY CODE

<p>CODICE TAPPO CON CHIAVE E SENZA CHIAVE CAP CODE WITH AND WITHOUT KEY</p>		<p>CODICE TAPPO CON CHIAVE E SENZA CHIAVE CAP CODE WITH AND WITHOUT KEY</p>	
<p>015575 - 0BD635 Tappo con chiave ø110 a baionetta interna ø38 x ø46 x 12, non ventilato Locking cap ø110 inside bayonet ø38 x ø46 x 12, non vented</p>  <p>PEUGEOT 206</p>	<p>98 ▶ 1/13</p>	<p>019625 - 0HH025 Tappo con chiave ø72,5 a baionetta interna ø38,5 x ø45 x 5, ventilato con valvola Locking cap ø72,5 inside bayonet ø38,5 x ø45 x 5, vented by venting system</p>  <p>ROVER 111 Cabriolet 211 - 213 - 214 - 216 - 218 - 220 214, 216 Cabriolet 25 400 - 414 - 416 - 418 - 820 - 827 Serie 100 5 porte (5 door) Serie 200 Serie 800 Streetwise Tourer</p>	<p>90 ▶ 2/00 ▶ 93 ▶ 4/96 90 ▶ 5/96 ▶ 5/96 ▶ 10/03 ▶ 93 ▶ 4/96</p>
<p>017903 - 0FH536 023466 Tappo a vite con chiave ø96 per bocch. In metallo M80 x 2 Locking cap screw ø96 for metal filler neck M80 x 2</p>  <p>ALFA ROMEO Alfa Camioncino (small lorry) 30 - 32 - 35 - 40 AR 8</p> <p>FIAT IVECO Autocarri (trucks) Daily 30 F8 Camioncino (Light Van)</p> <p>LANCIA Autocarri (trucks)</p> <p>OM - (IVECO) Autocarri (escluso 330) Trucks (excluded 330)</p>	<p>▶ 83 74 ▶ ▶ 83 75 ▶ 74 ▶</p>		





LEGEN

▶ Anno = fino al ...
Anno ▶ Anno = dal...al...
Anno ▶ = dal ...

KEY

▶ Year = up to ...
Year ▶ Year = from..up to..
Year ▶ = from ...

APPLICABILITA' SPECIFICHE DI OGNI TAPPO - APPLICATION BY CODE

CODICE TAPPO CON CHIAVE E SENZA CHIAVE CAP CODE WITH AND WITHOUT KEY			CODICE TAPPO CON CHIAVE E SENZA CHIAVE CAP CODE WITH AND WITHOUT KEY		
019627 - 0HH020	025212		019656 - 0HH591	025244	
Tappo ø72,5 a baionetta interna ø38,5 x ø46 x 12, ventilato con valvola Cap ø72,5 inside bayonet ø38,5 x ø46 x 12, vented by venting system			Tappo ø73 a baionetta interna ø39 x ø44,5 x 14,9, ventilato con valvola Cap ø73 inside bayonet ø39 x ø44,5 x 14,9, vented by venting system		
					
CHRYSLER Crossfire			BMW Active Tourer		7/14 ▶
ROVER 75	99 ▶		Grand Tourer		6/15 ▶
			Serie 1		8/04 ▶
			Serie 2		14 ▶
			Serie 3		02 ▶
			Serie 4		10/13 ▶
			Serie 5		02 ▶
			Serie 6		2/04 ▶
			Serie 7		02 ▶
			X1		9/09 ▶
			X2		12/17 ▶
			X3		2/04 ▶
			X4		06/14 ▶
			X5		02 ▶
			X6		3/08 ▶
			Z4		4/03 ▶ 1/17
			LAND ROVER Range Rover		3/02 ▶ 5/07
			MERCEDES Classe A		02 ▶
			Classe B		6/05 ▶
			Classe C Berlina, SW		02 ▶
			Classe E Berlina, SW		02 ▶
			Classe S		02 ▶
			CL		02 ▶
			CLA		3/13 ▶
			CLK		02 ▶
			CLS		11/04 ▶
			GLA		04/14 ▶
			GLC		08/15 ▶
			GLE		06/15 ▶
			GLK		02 ▶ 01/16
			SL		01 ▶
			SLC		3/16 ▶
			SLK		02 ▶ 12/16
			SLS Coupè		4/10 ▶
			SLS Cabrio		8/11 ▶
			MINI (Bmw) Mini		10/01 ▶







LEGENDA

▶ Anno = fino al ...
Anno ▶ Anno = dal...al...
Anno ▶ = dal ...

KEY

▶ Year = up to ...
Year ▶ Year = from...up to...
Year ▶ = from ...

APPLICABILITA' SPECIFICHE DI OGNI TAPPO - APPLICATION BY CODE

CODICE TAPPO CON CHIAVE E SENZA CHIAVE CAP CODE WITH AND WITHOUT KEY			CODICE TAPPO CON CHIAVE E SENZA CHIAVE CAP CODE WITH AND WITHOUT KEY			
019818 - 0HH007	025210		019858 - 0HH507	025428		
Tappo ø93,5 a baionetta interna ø33,5 x ø40,5 x 5,5, ventilato con valvola Cap ø93,5 inside bayonet ø33,5 x ø40,5 x 5,5, vented by venting system			Tappo ø122 a baionetta interna ø80 x ø87 x 14, ventilato con valvola Cap ø122 inside bayonet ø80 x ø87 x 14, vented by venting system			
 			 			
VOLKSWAGEN Golf Cabriolet			BUSSING (Autocarri / Trucks) DAF (Autocarri / Trucks) FORD (Autocarri / Trucks) HANOMAG HENSCHEL (Autocarri / Trucks) IVECO Autocarri (Trucks) Eurotech - Eurostar Eurotrakker Eurocargo 130 → 180E, 4x4 KAESSBOHRER (Autocarri / Trucks) KLOCKNER-HUMBOLT-DEUTZ (Autocarri / Trucks) MAGIRUS DEUTZ (Autocarri / Trucks) M.A.N. (Autocarri / Trucks) TGL - TGM - TGS - TGX Euro 6			88 ▶
			MERCEDES BENZ Autocarri pesanti (Trucks) : 814, S - 817 - 914, AK - 1117 - 1314 K, AK - 1317 - 1320, S - 1517, K - 1520 - 1826, L, S - 1833 L, LL, LS - 1922 K, AK - 1935, S - 1948, S - 2433 L, LL, - 6x2 - 2629 K, 2629 AK M.O. - 2635 K, S M.O. Autocarri con p.t.t. oltre 3,5T (cabinati 4x2 fino a 7,5t) : Trucks with capacity over 3,5T (cabin cruisers 4x2 up to 7,5t) : Atego 715, 815, 818, 822 Autocarri con p.t.t. oltre 3,5T (cabinati 4x2 da 7,6 a 12t) : Trucks with capacity over 3,5T (cabin cruisers 4x2 from 7,6 to 12t) : Atego 1018, 1022, 1023, 1218, 1222, 1223, 1228 Autocarri con p.t.t. oltre 3,5T (cabinati 4x2 da 12,1 a 18t) : Trucks with capacity over 3,5T (cabin cruisers 4x2 from 12,1 to 18t) : Atego 1318, 1322, 1323, 1328, 1523, 1528 Autocarri con p.t.t. oltre 3,5T (cabinati a 3 e a 4 assi) : Trucks with capacity over 3,5T (cabin cruisers with 3 and 4 axis) : Actros Linea (Euro 3) 2532, 2536, 2541, 2544, 2546, 2550, 2554, 2558 Actros Linea (BlueTec 4 / BlueTec 5) 2532, 2536, 2541, 2544, 2546, 2548, 2551, 2555, 2560 Actros Cantiere 2636, 2641, 2644, 2646, 2650, 3336, 3341, 3344, 3346, 3350, 4141, 4144, 4146, 4150			

Continua - To be continued



LEGENDA

▶ Anno = fino al ...
Anno ▶ Anno = dal...al...
Anno ▶ = dal ...

KEY

▶ Year = up to ...
Year ▶ Year = from...up to..
Year ▶ = from ...

APPLICABILITA' SPECIFICHE DI OGNI TAPPO - APPLICATION BY CODE

CODICE TAPPO CON CHIAVE E SENZA CHIAVE CAP CODE WITH AND WITHOUT KEY		CODICE TAPPO CON CHIAVE E SENZA CHIAVE CAP CODE WITH AND WITHOUT KEY	
<i>Prosegue - Continued</i> 019858 - 025428		<i>Prosegue - Continued</i> 019858 - 025428	
Axor 2528, 2533, 2535, 2540, 2543		Trucks with capacity over 3,5T (cabin cruisers with 3 and 4 axes) :	
Autocarri con p.t.t. oltre 3,5T (trattori a 2 assi) :		FM-260 6x2 - FM-300 6x2 - FM-340 6x2 - FM-380 6x2 - FM-400 6x2 - FM-440 6x2 - FM-480 6x2 - FM-400 8x2 - FM-440 8x2 - FM-480 8x2 - FH-400 6x2 - FH-440 6x2 - FH-480 6x2 - FH-500 6x2 - FH16-550 6x2 - FH16-610 6x2 - FH-400 8x2 - FH-440 8x2 - FH-480 8x2 - FH-520 8x2	
Trucks with capacity over 3,5T (tractors with 3 axis) :		Autocarri con p.t.t. 3,5T (trattori a 2 assi) :	
Actros Linea (Euro 3) 1832, 1836, 1841, 1844, 1846, 1850, 1854, 1858		Trucks with capacity over 3,5T (tractors with 2 axes) :	
Actros Linea (BlueTec 4 / BlueTec 5) 1832, 1836, 1841, 1844, 1846, 1848, 1851, 1855, 1860		FM-380 - FM-400 - FM-440 - FM-480 - FH-400 - FH-440 - FH-480 - FH-520 - FH16-550 - FH16-610	
Actros Linea (BlueTec 4 / BlueTec 5) 1832, 1836, 1841, 1844, 1846, 1848, 1851, 1855, 1860		Autocarri con p.t.t. 3,5T (trattori a 3 assi) :	
Actros Cantiere 1832, 1841, 1844, 2032, 2041, 2044, 2046, 2050		Trucks with capacity over 3,5T (tractors with 3 axes) :	
Corriere (Bus)		FH-400 Pusher 6x2 - FH-440 Pusher 6x2 - FH-480 Pusher 6x2 - FH-520 Pusher 6x2 - FH-400 6x4 - FH-440 6x4 - FH-480 6x4 - FH-520 6x4	
MITSUBISHI		FE - FH - FM - FMX Diesel tank Euro6	
Autocarri (Trucks) : Canter	99 ▶ 14		
OM - (IVECO)			
115/17 - 135/17			
PEGASO			
Autocarri (Trucks) : Troner			
RENAULT			
Autocarri (con serb. in lamiera 2 alette) Trucks (Fe metal tank 2-lug)			
AE Magnum 390/420T/430/470/560	4/96 ▶ 5/00		
Kerax			
Magnum (con serb. in lamiera 2 alette / Fe metal tank 2-lug)			
Master 4x2 - 4x4			
Master 6x4/8x4 (con serb. in lamiera 2 alette / Fe metal tank 2-lug)	7/92 ▶		
Midlum (con serb. in lamiera 2 alette / Fe metal tank 2-lug)			
Midlum Export (con serb. in lamiera 2 alette / Fe metal tank 2-lug)			
MS300 Sudamerica			
PG230/280			
Premium (con serb. in lamiera 2 alette / Fe metal tank 2-lug)			
Premium PR (con serb. in lamiera 2 alette / Fe metal tank 2-lug)			
Premium TR	2/96 ▶		
Premium Tracteur 4x2 (FAB22CC)	10/00 ▶		
Serie "C" (con serb. in lamiera 2 alette / Fe metal tank 2-lug)			
Serie "G" (con serb. in lamiera 2 alette / Fe metal tank 2-lug)			
Serie "G" Manager (con serb. in lamiera 2 alette / Fe metal tank 2-lug)			
Serie "M" (con serb. in lamiera 2 alette / Fe metal tank 2-lug)	▶ 9/96		
Serie "R" (con serb. in lamiera 2 alette / Fe metal tank 2-lug)			
SEDDON			
T5 - T6			
VOLKSWAGEN			
Autocarri (trucks) : MT 8136 - 9136			
VOLVO			
Autocarri con p.t.t. oltre 3,5T (cabinati da 12,1 a 18T) :			
Trucks with capacity over 3,5T (cabin cruisers from 12,1 to 18T) :			
FM-260 - FM-300 - FM-340 - FM-380 - FM-400 - FM-440 - FM-480 - FH-400 - FH-440 - FH-480 - FH-520			
Autocarri con p.t.t. oltre 3,5T (cabinati a 3 e a 4 assi) :			

019866 - OBD525

Tappo con chiave ø94 a baionetta interna ø58,5 x ø66 x 8, ventilato con valvola
 Locking cap ø94 inside bayonet ø58,5 x ø66 x 8, vented by venting system



LAND ROVER

90 - 110



LEGENDA

▶ Anno = fino al ...
 Anno ▶ Anno = dal...al...
 Anno ▶ = dal ...

KEY

▶ Year = up to ...
 Year ▶ Year = from...up to..
 Year ▶ = from ...

APPLICABILITA' SPECIFICHE DI OGNI TAPPO - APPLICATION BY CODE

CODICE TAPPO CON CHIAVE E SENZA CHIAVE CAP CODE WITH AND WITHOUT KEY			CODICE TAPPO CON CHIAVE E SENZA CHIAVE CAP CODE WITH AND WITHOUT KEY		
019870 - 0HH589	025430		<i>Prosegue - Continued</i>	019882	
<p>Tappo ø88 a baionetta interna ø58,3 x 65,8 x 16, ventilato con valvola Cap ø88 inside bayonet ø58,3 x ø65,8 x 16, vented by venting system</p>  			<p>Serie "B" Serie "C" (con serb. in lamiera 3 alette / Fe metal tank 3-lug) Serie "G" (con serb. in lamiera 3 alette / Fe metal tank 3-lug) Serie "G" Manager (con serb. in lamiera 3 alette / Fe metal tank 3-lug) Serie "M" (con serb. in lamiera 3 alette / Fe metal tank 3-lug) Serie "MS" (con serb. in lamiera 3 alette / Fe metal tank 3-lug) Serie "R" (con serb. in lamiera 3 alette / Fe metal tank 3-lug) Serie "S" (con serb. in lamiera 3 alette / Fe metal tank 3-lug)</p>		2/93 ▶
<p>LAND ROVER Defender</p>		94 ▶ 10/01			
<p>SCANIA Autocarri Serie 2 - Serie 3 (Trucks Series 2 - Series 3)</p>		89 ▶ 97			
019882	025442		019884	025428	
<p>Tappo ø122 baionetta interna ø89 x ø97 x 8 (3 denti), ventilato con valvola Cap ø122 inside bayonet ø89 x ø97 x 8 (3 lug), vented by venting system</p>  			<p>Tappo ø129 a baionetta interna ø78,5 x ø86,9 x 20, ventilato con valvola Cap ø129 inside bayonet ø78,5 x ø86,9 x 20, vented by venting system</p>  		
<p>RENAULT Autocarri (con serb. in lamiera 3 alette) Trucks (Fe metal tank 3-lug) AE 380/385TI/420TI/500/520 JE13/15 M/S 4x4 & INCENDIE M210 4x4 Master 6x4/8x4 (con serb. in lamiera 3 alette / Fe metal tank 3-lug) ME/SE/CE/190/180/210 Midliner Grande-Bretagne Midlum (con serb. in lamiera 3 alette / Fe metal tank 3-lug) PS 150/160</p>		<p>▶ 9/96 ▶ 11/96 12/96 ▶ 7/92 ▶ ▶ 11/01</p>	<p>IVECO Stralis</p>		
		<i>Continua - To be continued</i>			



LEGENDA

▶ Anno = fino al ...
Anno ▶ Anno = dal...al...
Anno ▶ = dal ...

KEY

▶ Year = up to ...
Year ▶ Year = from...up to..
Year ▶ = from ...

APPLICABILITA' SPECIFICHE DI OGNI TAPPO - APPLICATION BY CODE

CODICE TAPPO CON CHIAVE E SENZA CHIAVE CAP CODE WITH AND WITHOUT KEY	⌚	CODICE TAPPO CON CHIAVE E SENZA CHIAVE CAP CODE WITH AND WITHOUT KEY	⌚
065001 - OKD060		065007 - OKD139	
Tappo con chiave ø48,5 per bocch. a baionetta interna con foro 35x35, non ventilato Locking cap ø48,5 for inside bayonet filler neck with hole 35x35, non vented		Tappo con chiave ø48,5 per bocch. a baionetta interna ø35, non ventilato Locking cap ø48,5 for inside bayonet filler neck ø35, non vented	
			
ALFA ROMEO Alfa Furgone (van)(2°serie) 30 - 32 - 35 - 40 AR8	▶ 83	AUTOBIANCHI Y 10	
FIAT 127 C, L, CL	77 ▶	FIAT 126 bis	
127 Fiorino D	83 ▶ 87	Argenta	
127 Sport, Panorama, Fiorino	83 ▶ 87	Cinquecento	93 ▶ 98
128 Sport - 3P		Croma	▶ 86
Duna		Ducato, Ducato Maxi	90 ▶ 93
Fiorino	88 ▶ 93	Panda 4x4	87 ▶ 2/01
Penny Diesel		Panda 750 - 1000 - Elett.	
Uno CS		Panda 900 young	87 ▶ 12/00
FIAT IVECO OM Daily 30 F8 Minibus e Combi, Furgone (van)	▶ 83	Uno (escluso CS excluded)	
Grinta 30,8 - 35,8 Furgoni (van)(2° serie)	▶ 83	INNOCENTI Elba - Nuova Elba1,5 Catal.	
MOTOR IBERICA Ebro F275	81 ▶	Elba Happy	
NISSAN Trade		Mille clip, Super Clip	95 ▶
OM - (IVECO) 30.8 Diesel, 35.8 Diesel	▶ 83	ITALJET Microcar sprint	
SEAT Fura		IVECO Talento	
		LANCIA Delta HF integrale	91 ▶ 2/95
		Thema	▶ 86
		LIGIER 162 GL diesel	96 ▶



LEGENDA

 ▶ Anno = fino al ...
 Anno ▶ Anno = dal...al...
 Anno ▶ = dal ...

KEY

 ▶ Year = up to ...
 Year ▶ Year = from..up to..
 Year ▶ = from ...

APPLICABILITA' SPECIFICHE DI OGNI TAPPO - APPLICATION BY CODE

CODICE TAPPO CON CHIAVE E SENZA CHIAVE CAP CODE WITH AND WITHOUT KEY			CODICE TAPPO CON CHIAVE E SENZA CHIAVE CAP CODE WITH AND WITHOUT KEY		
065216 - OKD620			025244		
Tappo ø72,5 a baionetta interna ø39 x ø44,5 x 14,9, ventilato con valvola Cap ø72,5 inside bayonet ø39 x ø44,5 x 14,9, vented by venting system			<i>Prosegue - Continued</i> 065216 - 025244		
			FIAT 500 (Nuova) 9/07 ▶ 500 Cabrio 8/09 ▶ Barchetta 99 ▶ Brava, Bravo 7/98 ▶ Bravo 3/07 ▶ 10/14 Cromia 6/05 ▶ 2/11 Doblò, Doblò cargo 12/00 ▶ Ducato 99 ▶ Fiorino 12/07 ▶ Idea 12/03 ▶ Marea 7/98 ▶ Multipla Panda (Nuova) 10/03 ▶ 10/12 Panda 1100 Hobby, Young, College 01 ▶ Panda 4x4 3/01 ▶ 10/12 Panda Van 12/03 ▶ Punto 98 ▶ 5/11 Punto (Grande) 10/05 ▶ Punto (Grande) Van 06 ▶ Punto Evo 10/09 ▶ 7/12 Seicento 5/98 ▶ Stilo 10/01 ▶ 08 Stilo Station Wagon 1/03 ▶ 7/09 Qubo 9/08 ▶		
ABARTH 500 3/08 ▶ 500 Cabrio 8/10 ▶ 595 Berlina, Cabrio 9/12 ▶ 695 9/14 ▶ Punto Evo 8/10 ▶ 6/12 Punto 6/12 ▶			FORD Ka 12/08 ▶ 12/16		
ALFA ROMEO 145 99 ▶ 00 146 99 ▶ 00 147 12/00 ▶ 3/11 156 7/00 ▶ 07 159 Berlina, SW 9/05 ▶ 166 7/00 ▶ Giulia 6/16 ▶ Giulietta 5/10 ▶ GT 1/04 ▶ 2/11 GTV 7/00 ▶ 05 Mito 8/08 ▶ Spider 7/00 ▶ 9/11 Stelvio 3/17 ▶			IVECO Daily 99 ▶ Daily City Van Daily City Van		
CITROËN Jumper 99 ▶ Nemo 1/08 ▶			LANCIA Delta 6/08 ▶ Lybra 99 ▶ 05 Musa 9/04 ▶ Thesis 7/02 ▶ 2/09 Ypsilon 98 ▶ 9/06 Ypsilon 2006 10/06 ▶ 4/13		
<i>Continua - To be continued</i>			<i>Continua - To be continued</i>		



LEGENDA

 ▶ Anno = fino al ...
 Anno ▶ Anno = dal...al...
 Anno ▶ = dal ...

KEY

 ▶ Year = up to ...
 Year ▶ Year = from...up to..
 Year ▶ = from ...

APPLICABILITA' SPECIFICHE DI OGNI TAPPO - APPLICATION BY CODE

CODICE TAPPO CON CHIAVE E SENZA CHIAVE CAP CODE WITH AND WITHOUT KEY			CODICE TAPPO CON CHIAVE E SENZA CHIAVE CAP CODE WITH AND WITHOUT KEY		
<i>Prosegue - Continued</i> 065216 - 025244			065220 - 0KD632		
FIAT			Tappo con chiave ø72,5 per bocch. a baionetta interna ø40, ventilato con valvola Locking cap ø72,5 for inside bayonet filler neck ø40, vented by venting system		
500 (Nuova)	9/07 ▶				
500 Cabrio	8/09 ▶				
Barchetta	99 ▶				
Brava, Bravo	7/98 ▶				
Bravo	3/07 ▶				
Croma	6/05 ▶ 2/11				
Doblò, Doblò cargo	12/00 ▶				
Ducato	99 ▶				
Fiorino	12/07 ▶				
Idea	12/03 ▶				
Marea	7/98 ▶				
Multipla					
Panda (Nuova)	10/03 ▶ 10/12				
Panda 1100 Hobby, Young, College	01 ▶				
Panda 4x4	3/01 ▶ 10/12				
Panda Van	12/03 ▶				
Punto	98 ▶ 5/11				
Punto (Grande)	10/05 ▶				
Punto (Grande) Van	06 ▶				
Punto Evo	10/09 ▶ 7/12				
Seicento	5/98 ▶				
Stilo	10/01 ▶ 08				
Stilo Station Wagon	1/03 ▶ 7/09				
Qubo	9/08 ▶				
FORD			FORD		
Ka	12/08 ▶		Focus	98 ▶ 10/01	
			Transit	1/00 ▶ 14	
			Transit Van, Chassis, Combi	06 ▶	
IVECO					
Daily	99 ▶				
Daily City Van					
Daily City Van					
LANCIA					
Delta	6/08 ▶				
Lybra	99 ▶ 05				
Musa	9/04 ▶				
Thesis	7/02 ▶ 2/09				
Ypsilon	98 ▶ 9/06				
Ypsilon 2006	10/06 ▶ 4/13				
OPEL					
Combo	12 ▶				
PEUGEOT					
Bipper	08 ▶				
Bipper Tepee	3/09 ▶				
Boxer	06 ▶				







LEGENDA

 ▶ Anno = fino al ...
 Anno ▶ Anno = dal...al...
 Anno ▶ = dal ...

KEY

 ▶ Year = up to ...
 Year ▶ Year = from..up to..
 Year ▶ = from ...

APPLICABILITA' SPECIFICHE DI OGNI TAPPO - APPLICATION BY CODE

<p>CODICE TAPPO CON CHIAVE E SENZA CHIAVE CAP CODE WITH AND WITHOUT KEY</p>		<p>CODICE TAPPO CON CHIAVE E SENZA CHIAVE CAP CODE WITH AND WITHOUT KEY</p>	
<p>065513 OKD564 Tappo con chiave ø98 per bocch. a baionetta interna ø44, non ventilato Locking cap ø98 for inside bayonet filler neck ø44, non vented</p>  <p>FIAT Cinquecento</p>	<p>92 ▶ 93</p>	<p>065519 - OBD651 Tappo con ch. cop. ovale 121x105, per bocch. a baionetta int. Ø41, non ventilato Locking cap, oval cap cover 121x105, for ins. bayonet filler neck ø41, non vented</p>  <p>RENAULT Express</p>	<p>12/94 ▶</p>
<p>065515 - OBD609 Tappo con chiave ø111 per bocch. a baionetta interna ø41, non ventilato Locking cap ø111 for inside bayonet filler neck ø41, non vented</p>  <p>CITROËN Jumpy</p> <p>FIAT Scudo</p>	<p>▶ 4/07</p> <p>▶ 1/07</p>	<p>065521 - OBD652 Tappo con ch., cop. ovale 155x117, per bocch. a baionetta int. Ø38, non ventilato Locking cap, oval cap cover 155x117, for ins. bayonet filler neck ø38, non vented</p>  <p>RENAULT Kangoo 4 porte (4 door) Kangoo Express</p>	<p>97 ▶ 08</p> <p>97 ▶</p>







LEGENDA

▶ Anno = fino al ...
Anno ▶ Anno = dal...al...
Anno ▶ = dal ...

KEY

▶ Year = up to ...
Year ▶ Year = from..up to..
Year ▶ = from ...

APPLICABILITA' SPECIFICHE DI OGNI TAPPO - APPLICATION BY CODE

<p>CODICE TAPPO CON CHIAVE E SENZA CHIAVE CAP CODE WITH AND WITHOUT KEY</p>		<p>CODICE TAPPO CON CHIAVE E SENZA CHIAVE CAP CODE WITH AND WITHOUT KEY</p>	
<p>065541 - 0BD653</p> <p>Tappo con ch., cop. ovale 155x117, per bocch. a baionetta int. Ø41, non ventilato Locking cap, oval cap cover 155x117, for ins. bayonet filler neck Ø41, non vented</p>  <p>Calamita Magnet</p> <p>RENAULT Kangoo 5 porte (5 door)</p>	<p>1/00 ▶</p>	<p>067702 - 0QD475 023201</p> <p>Tappo a vite con chiave Ø74,5 per bocch. In metallo M60 x 2, ventilato Locking cap screw Ø74,5 for metal filler neck M60 x 2, vented</p>  <p>AUTOBIANCHI Bianchina - Giardiniera</p> <p>CITROËN T 23 - T 50 - T 350 CH CAB</p> <p>FIAT 1100 R Familiare 124 Spider 500 600 850, Coupé, Familiare (estate) 900 E Pulmino Bus 900 T, Shango, Promiscuo Dino</p> <p>OM 35 A</p> <p>PEUGEOT J 7</p> <p>ZASTAVA 750</p>	<p>68 ▶ ▶ 68 69 ▶ 75 65 ▶ 1/6/67 ▶</p> <p>▶ 68</p>
<p>065564 025470</p> <p>Tappo Ø110 per bocch. a baionetta interna Ø58,8, ventilato con valvola Cap Ø110 for inside bayonet filler neck Ø58,8, vented by venting system</p>   <p>IVECO Eurocargo Euro 6 Stralis Euro 6 Trakker Euro 6</p>	<p>11/13 ▶</p>		









LEGENDA

▶ Anno = fino al ...
Anno ▶ Anno = dal...al...
Anno ▶ = dal ...

KEY

▶ Year = up to ...
Year ▶ Year = from...up to..
Year ▶ = from ...

APPLICABILITA' SPECIFICHE DI OGNI TAPPO - APPLICATION BY CODE

CODICE TAPPO CON CHIAVE E SENZA CHIAVE CAP CODE WITH AND WITHOUT KEY			CODICE TAPPO CON CHIAVE E SENZA CHIAVE CAP CODE WITH AND WITHOUT KEY		
067703 - 0QD153 023203			067709 - 0QD217 023341		
Tappo a vite con ch. ø74,5 per bocch. In plastica M55 x 6, non ventilato Locking cap screw ø74,5 for plastic filler neck M55 x 6, non vented			Tappo a vite ø77,5 per bocchettone In plastica M53 x 4, non ventilato Cap screw ø77,5 for plastic filler neck M53 x 4, non vented		
			 		
FIAT Ritmo - Regata (bocchettone Plast. / Plastic filler)		84 ▶	FIAT Ducato Panda 30 Panda 34		88 ▶ 89 4/84 ▶
067707 - 0QD291 023339			067749 - 0QD130 023349		
Tappo ø74,5 a vite femmina ø55,6 p.4 per bocchettone in plastica, non ventilato Cap ø74,5 screw female ø55,6 x 4 for plastic filler neck, non vented			Tappo ø77,5 a vite femmina ø60 p.2 per bocchettone in metallo, non ventilato Cap ø77,5 screw female ø60 x 2 for metal filler neck, non vented		
 			 		
ALFA ROMEO 75 - 90			ALFA ROMEO Alfa 35 - AR8 Camioncino (small lorry) doppia cab. (double cab) Alfa Furgone (van) 30 - 35 AR8 (1° serie)		
ALFASUD 33 - 33 (4x4)			AUTOBIANCHI A111 - A112		

Continua - To be continued

LEGENDA

▶ Anno = fino al ...
Anno ▶ Anno = dal...al...
Anno ▶ = dal ...

KEY

▶ Year = up to ...
Year ▶ Year = from...up to..
Year ▶ = from ...

APPLICABILITA' SPECIFICHE DI OGNI TAPPO - APPLICATION BY CODE

CODICE TAPPO CON CHIAVE E SENZA CHIAVE CAP CODE WITH AND WITHOUT KEY	🕒	CODICE TAPPO CON CHIAVE E SENZA CHIAVE CAP CODE WITH AND WITHOUT KEY	🕒
<i>Prosegue - Continued</i> 067749 - 023349		<i>Prosegue - Continued</i> 067749 - 023349	
FIAT		OM - (IVECO)	
1100 R		35.8 Doppia Cabina (double cab) Diesel	▶ 83
124, Spider, Sport, Special T	69 ▶	PEUGEOT	
125		J5	▶ 87
126		POLSKI - FIAT	
127, Special		125 P - 126 P - 127 P - 132 P	
128		SEAT	
131 Mirafiori L, CL		124 - 127 - 132 - 1430	
131 Mirafiori Panorama L, CL		Marbella	▶ 93
131 Supermirafiori	▶ 81	Ronda	
132 2000		Terra	▶ 93
238 - E Panorama - E Andal		YETI	
241		Yem 903	
Campagnola (Savio)		ZASTAVA	
Ducato	▶ 87	101 - 125 PZ, PZ Special	
Panda 30	▶ 4/84		
Panda 45			
Regata (bocch. Lamiera / Metal filler)			
Ritmo (bocch. Lamiera / Metal filler)			
FISSORE			
127 Scout - Elaborazione			
128 Elaborazione			
GIANNINI			
126 - 128 NP5 - 132			
127 NP - 127 NP3			
1600 Rally			
IVECO			
Daily 30 F8 Camioncino (small lorry) Doppia Cab. (double cab)	▶ 83		
Daily 30 F8 Minibus e Combi (1° serie)			
Grinta 30,8 - 35,8 (1° serie)			
Grinta 30,8 - 35,8 Cam. (small lorry) Doppia Cab. (double cab)	▶ 83		
2105 - 2107			
LADA			
Niva	95 ▶		
1200 - 1300 - 1500 - 1600 - 2105 - 2107			
LAMBORGHINI			
Espada - Jarama			
LANCIA			
Beta			
Delta - Prisma - Trevi	▶ 86		
MASERATI			
Biturbo			
MORETTI			
126 Minimaxi			
127 Midimaxi - Paguro			
NIVA HNBA			
1600			
<i>Continua - To be continued</i>			
		067753 - 0QD476	023337
		Tappo a vite ø72,5 per bocch. In metallo M45 x 5, non ventilato Cap screw ø72,5 for metal filler neck M45 x 5, non vented	
			
		PORSCHE	
		924	81 ▶ 90
		VOLKSWAGEN	
		Maggiolone (Beetle)	74 ▶



LEGENDA

▶ Anno = fino al ...
Anno ▶ Anno = dal...al...
Anno ▶ = dal ...

KEY

▶ Year = up to ...
Year ▶ Year = from...up to..
Year ▶ = from ...

APPLICABILITA' SPECIFICHE DI OGNI TAPPO - APPLICATION BY CODE

CODICE TAPPO CON CHIAVE E SENZA CHIAVE CAP CODE WITH AND WITHOUT KEY			CODICE TAPPO CON CHIAVE E SENZA CHIAVE CAP CODE WITH AND WITHOUT KEY		
067754 - 0QD449			023334		
Tappo ø 72 a vite maschio ø44 p.6,3 per bocch. In plastica, ventilato con valvola Cap ø72 screw male ø44 x 6,3 for plastic filler neck, vented by venting system			<i>Prosegue - Continued</i> 067754 - 023334		
			Kalos 2/05 ▶ 07 Lacetti 3/05 ▶ 1/11 Matiz 2/05 ▶ 1/11 Nubira 3/05 ▶ 06 Nubira SW 2/05 ▶ 1/11 Orlando 3/11 ▶ Spark 3/10 ▶ Tacuma 2/05 ▶ 2/11 Trax 4/13 ▶ CHRYSLER 300 M ▶ 99 Grand Voyager 94 ▶ 99 Neon 4 porte (4 door) 96 ▶ Stratus 95 ▶ Stratus Cabrio 96 ▶ Viper GTS 8/97 ▶ Vision 3,5 94 ▶ Voyager 3,3 LE 94 ▶ 99 CITROËN C1 7/05 ▶ DAEWOO Espero Lanos 8/97 ▶ Leganza 11/97 ▶ Matiz 7/98 ▶ 1/05 Nexia GLX, GTX Nubira 8/97 ▶ 2/05 Nubira S.W. 8/97 ▶ 1/05 Tacuma 8/00 ▶ 1/05 DAIHATSU Copen 3/04 ▶ 9/10 Cuore 2/99 ▶ 1/12 Feroza ▶ 90 Materia 1/07 ▶ 1/12 Sirion 9/00 ▶ Terios 9/00 ▶ Trevis 11/06 ▶ 4/11 DATSUN Bluebird - Laurel - Sunny 85 ▶ DODGE Charger 75 ▶ Omni 78 ▶ DR City Cross 10/13 ▶ 3/17 DR5 07 ▶ 2/17		
ALFA ROMEO					
156	98 ▶ 6/00				
164	94 ▶				
166	98 ▶ 6/00				
GTV	95 ▶ 6/00				
Spyder	95 ▶ 6/00				
ALFASUD					
Arna					
AUDI					
80 - 90 - 100 - 200 - Quattro	88 ▶				
80 Cabriolet	93 ▶				
Coupe	90 ▶				
A1	7/10 ▶				
A2	12/00 ▶				
A3 3/5 porte (3/5 door), Cabrio	10/96 ▶ 9/13				
A4 Berlina, SW	95 ▶ 10/07				
A6	94 ▶ 2/11				
A6 S.W.	▶ 6/11				
A8	96 ▶ 2/10				
R8	07 ▶				
V8	90 ▶				
BUICK					
Century	77 ▶				
Electra - Le Sabre	75 ▶				
Regal	78 ▶				
Riviera - Skylark	75 ▶				
CADILLAC					
Dewille - Fleetwood	75 ▶				
Eldorado	78 ▶				
Seville	79 ▶				
CHEVROLET					
Aveo	06 ▶ 9/13				
Baby Blazer - Chevy Van					
Camaro - Impala - Malibu	75 ▶				
Captiva	8/06 ▶				
Chevette	78 ▶				
Cruze 4P, 5P, SW	5/09 ▶				
Epica	6/06 ▶ 2/11				
<i>Continua - To be continued</i>			<i>Continua - To be continued</i>		



LEGENDA

▶ Anno = fino al ...
Anno ▶ Anno = dal...al...
Anno ▶ = dal ...

KEY

▶ Year = up to ...
Year ▶ Year = from...up to..
Year ▶ = from ...

APPLICABILITA' SPECIFICHE DI OGNI TAPPO - APPLICATION BY CODE

CODICE TAPPO CON CHIAVE E SENZA CHIAVE CAP CODE WITH AND WITHOUT KEY			CODICE TAPPO CON CHIAVE E SENZA CHIAVE CAP CODE WITH AND WITHOUT KEY		
<i>Prosegue - Continued</i> 067754 - 023334			<i>Prosegue - Continued</i> 067754 - 023334		
FIAT			i40		4/12 ▶
Barchetta	▶ 98		i40 S.W.		8/11 ▶
Palio Weekend	97 ▶ 03		Ioniq		8/16 ▶
Sedici	4/06 ▶		ix20		12/10 ▶
Strada	6/06 ▶		ix35		5/10 ▶ 10/15
FORD			Kona		12/17 ▶
EcoSport	6/14 ▶ 12/15		Lantra (benz. Verde / unleaded)		
Fiesta	6/02 ▶ 9/08		Matrix		10/01 ▶ 9/10
Focus	11/01 ▶ 11/04		Pony		
Fusion	9/03 ▶ 12/12		S Coupè LS		94 ▶
Ka cabrio	12/08 ▶		Santa Fe		2/01 ▶
Mondeo Berlina e S.W.	93 ▶ 5/07		Santamo		99 ▶
Scorpio	95 ▶ 99		Sonata		93 ▶
GREAT WALL			Sonica		87 ▶ 9/10
Hover	06 ▶		Terracan		1/02 ▶
Steed	08 ▶		Tiburon		12/97 ▶
HONDA			Trajjet		5/00 ▶
Accord Berlina, S.W.	90 ▶		Tucson		8/04 ▶ 12/10
Civic	94 ▶ 3/13				7/15 ▶
Civic Benzina (petrol)	3/13		Veloster		10/11 ▶
Civic IMA	01/04 ▶ 10/11		V6 Wagon Innovation		99 ▶
CR-V	6/97 ▶ 3/13		XG		6/01 ▶
CR-V Benzina (petrol)	12/12 ▶		INFINITI		
CR-Z	7/10 ▶ 7/13		EX		9/10 ▶
CRX Vti Targa - CRX Esi Targa	93 ▶		FX		9/10 ▶
FR - V	12/04 ▶ 2/11		G Berlina		9/10 ▶
HR - V	▶ 3/18		G Cabrio		9/10 ▶
Insight	3/09 ▶		G Coupè		9/10 ▶
Integra	2/98 ▶ 06		M		9/10 ▶
Jazz	2/02 ▶		Q30		2/16 ▶
Legend	▶ 10/11		Q50		1/14 ▶
Logo			Q70		11/15 ▶
NSX 3,2 coupé, Open Top	12/97 ▶		QX30		8/16 ▶
Prelude	94 ▶ 5/01		QX50		5/14 ▶
S2000	4/07 ▶ 8/09		QX70		11 ▶
Shuttle	1/98 ▶		JEEP		
HYUNDAI			Cherokee		2/96 ▶ 99
Accent	95 ▶ 4/11		Grand Cherokee		▶ 99
Atos GL, GLS	3/98 ▶ 08		Wrangler		▶ 06/09
Atos Prime	2/00 ▶ 6/09		KIA		
Coupè	9/96 ▶ 3/11		Carens		2/01 ▶
Elantra	2/01 ▶ 06		Carnival		6/99 ▶ 2/11
Furgone (van) H 100			Cee'd berlina		3/07 ▶
Galloper	1/98 ▶ 03		Cee'd station wagon		10/07 ▶
Genesis	3/11 ▶		Cerato		12/04 ▶ 08
Getz	10/02 ▶ 3/11		Clarus		
H1	6/98 ▶		K2500 Camioncino (small lorry)		12/04 ▶
i10	5/08 ▶		Magentis		12/03 ▶ 5/09
i20	3/09 ▶		Niro		3/17 ▶
i30	9/07 ▶		Opirus		12/03 ▶ 08
i30 S.W.	6/08 ▶				



Continua - To be continued
Continua - To be continued
LEGENDA

▶ Anno = fino al ...
Anno ▶ Anno = dal...al...
Anno ▶ = dal ...

KEY

▶ Year = up to ...
Year ▶ Year = from...up to..
Year ▶ = from ...

APPLICABILITA' SPECIFICHE DI OGNI TAPPO - APPLICATION BY CODE

CODICE TAPPO CON CHIAVE E SENZA CHIAVE CAP CODE WITH AND WITHOUT KEY			CODICE TAPPO CON CHIAVE E SENZA CHIAVE CAP CODE WITH AND WITHOUT KEY		
<i>Prosegue - Continued</i> 067754 - 023334			<i>Prosegue - Continued</i> 067754 - 023334		
Picanto	4/04 ▶		MCC		
Pregio Furgone (van)	12/04 ▶		Smart	9/98 ▶	2/99
Pride					
Rio	1/01 ▶		MERCEDES		
Sephia - Sportage MRDI			Serie ML	12/99 ▶	3/05
Shuma					
Sorento	7/02 ▶		MITSUBISHI		
Soul	5/09 ▶		3000 GT		
Sportage			ASX	9/10 ▶	8/15
Stonic	11/17 ▶		Carisma	5/96 ▶	
Stinger	4/18 ▶		Colt	3/94 ▶	4/12
Venga	4/10 ▶		Colt CC	6/06 ▶	
			Eclipse 2,0 GS		
LANCIA			Eclipse Cross	1/18 ▶	
"k"	11/94 ▶ 00		Grandis	11/05 ▶	3/11
			Lancer	3/94 ▶	7/13
LAND ROVER			Outlander	11/04 ▶	2/07
Defender	11/01 ▶ 10/10		Outlander	12/12 ▶	
Discovery	▶ 6/09		Pajero	1/96 ▶	
Range Rover	95 ▶ 2/02		Pick-Up L200	10/00 ▶	
			Space Gear		
LEXUS			Space Runner	91 ▶	
CT	2/11 ▶		Space Star	11/98 ▶	
GS	95 ▶		Space Wagon	91 ▶	
IS	05 ▶				
LS	95 ▶				
NX	14 ▶				
RX	09 ▶		NISSAN		
			200 SK	89 ▶	
MAHINDRA			3000		
Genio	15 ▶		350Z	05/03 ▶	06/09
Xuv500	11/92 ▶		Almera berl., Tino, NX		
	12/05 ▶ 1/11		Bluebird		
MAZDA	11/92 ▶		Cabstar	95 ▶	
121	12/05 ▶ 1/11		Evalia	12 ▶	
323 4WD	04 ▶		Juke	8/10 ▶	
323 F Lantis	4/06 ▶		Leaf	3/12 ▶	
526			Maxima QX		
626	94 ▶		Micra	11/92 ▶	
BT50	4/07 ▶		Micra C+C	12/05 ▶	1/11
CX-3	6/15 ▶		Murano	04 ▶	12/15
CX-5	4/12 ▶		Note	4/06 ▶	7/17
CX-7	6/07 ▶ 13		NV200	10 ▶	
Demio	▶ 03		Pathfinder	05 ▶	
Mazda2	4/03 ▶		Patrol	5/98 ▶	11/09
Mazda3	12/03 ▶		Pickup		
Mazda5	9/05 ▶ 6/13		Pixo	6/09 ▶	
Mazda6	9/02 ▶		Primera berl. e Station Wagon		
Mazda MPV	8/00 ▶ 06		Pulsar	11/14 ▶	
Mazda RX8	9/03 ▶ 6/09		Qashqai	2/07 ▶	
MPV 2,5 turbodiesel GLX	6/96 ▶		Serena	1/93 ▶	
Spider MX5, RX7	90 ▶		Sunny 1300 - 1500		
MX5 Coupè	12/06 ▶		Terrano	95 ▶	3/05
Xedos 6 - Xedos 9			Vanette Cargo 2,3 D	8/95 ▶	
Xuv500			X-Trail	10/01 ▶	



Continua - To be continued
Continua - To be continued
LEGENDA

▶ Anno = fino al ...
Anno ▶ Anno = dal...al...
Anno ▶ = dal ...

KEY

▶ Year = up to ...
Year ▶ Year = from...up to..
Year ▶ = from ...

APPLICABILITA' SPECIFICHE DI OGNI TAPPO - APPLICATION BY CODE

CODICE TAPPO CON CHIAVE E SENZA CHIAVE CAP CODE WITH AND WITHOUT KEY			CODICE TAPPO CON CHIAVE E SENZA CHIAVE CAP CODE WITH AND WITHOUT KEY		
<i>Prosegue - Continued</i> 067754 - 023334			<i>Prosegue - Continued</i> 067754 - 023334		
OLDSMOBILE			SAAB		
Delta 88 - Omega - Tornado	75 ▶		900	81 ▶	
OPEL			9000		
Adam	2/13 ▶		9-3	9/98 ▶	
Agila	9/00 ▶ 9/15		9-5	10/97 ▶	
Ampera	4/12 ▶ 4/15		SEAT		
Antara	12/06 ▶ 11/17		Altea	5/04 ▶ 12/15	
Astra Berlina, SW	5/98 ▶		Arosa	8/97 ▶	
Astra Van	09 ▶		Cordoba	94 ▶ 8/09	
Cascada	5/13		Exeo	4/09 ▶	
Combo	3/02 ▶ 12		Exeo S.W.	9/09 ▶	
Corsa	93 ▶		Ibiza	5/93 ▶ 6/17	
Corsa Van	06 ▶		Ibiza S.W.	7/10 ▶	
Frontera	99 ▶ 04		Inca Furgone (van)		
Insigna Berlina, SW	2/09 ▶		Leon	2/00 ▶ 1/13	
Karl	6/15 ▶		Mii	6/12 ▶	
Meriva	▶ 9/17		Toledo		
Mokka	12/12 ▶		SKODA		
Omega, Omega S.W.	94 ▶ 03		Citingo	7/12 ▶	
Signum	03 ▶ 08		Fabia	3/00 ▶	
Sintra	97 ▶		Felicia	▶ 01	
Tigra	94 ▶ 01		Felicia Wagon	▶ 01	
Vectra	11/95 ▶ 12/08		Octavia	▶ 5/13	
Zafira	99 ▶		Pick up Lxi (deriv. Felicia)	1/96 ▶	
Zafira Tourer	12/11 ▶		Rapid	1/12 ▶	
PEUGEOT			Roomster	9/06 ▶ 12/15	
107	12/05 ▶		Superb	7/02 ▶ 7/15	
108	6/14 ▶		Yeti	9/09 ▶ 1/18	
PLYMOUTH			SMART		
Fury	78 ▶		Smart (all models)	3/99 ▶ 10/14	
Horizon	79 ▶		SSANGYONG		
PONTIAC			Actyon	1/07 ▶ 11/11	
Bonneville	75 ▶		Kyron	1/06 ▶ 11/11	
Firebird	75 ▶		Korando	2/11 ▶	
Grand Prix	75 ▶		Musso	▶ 02	
Trans Sport 2,3 16V			Rexton	02 ▶	
PORSCHE			Tivoli	8/15 ▶	
911 - 944	8/12 ▶		XLV	4/16 ▶	
RENAULT			SUBARU		
21	93 ▶		BRZ	8/12 ▶	
Alaskan	11/17 ▶		Forester	11/97 ▶	
Kadjar	8/15 ▶		Impreza	▶	
Koleos	7/08 ▶ 2/16		Justy	12/07 ▶ 2/11	
ROVER			Legacy - Leone SW		
45	4/00 ▶		Levorg	14 ▶	
618 - 620			Outback	2/01 ▶	
Serie 400 4 porte (4 door)	5/96 ▶		Trezia	4/11 ▶	
Tourer	11/96 ▶		Vivio		
			WRX	07 ▶	
			XV	3/12 ▶	







Continua - To be continued
Continua - To be continued
LEGENDA

▶ Anno = fino al ...
Anno ▶ Anno = dal...al...
Anno ▶ = dal ...

KEY

▶ Year = up to ...
Year ▶ Year = from...up to...
Year ▶ = from ...

APPLICABILITA' SPECIFICHE DI OGNI TAPPO - APPLICATION BY CODE

CODICE TAPPO CON CHIAVE E SENZA CHIAVE CAP CODE WITH AND WITHOUT KEY			CODICE TAPPO CON CHIAVE E SENZA CHIAVE CAP CODE WITH AND WITHOUT KEY		
067769 - 0QD481 023343			067779 - 0QD485 023315		
Tappo ø77,5 filettato femmina ø62,5 x 6,35, non ventilato Cap ø77,5 female screw ø62,5 x 6,35, non vented			Tappo ø65 a vite maschio ø43,6 p.6 per bocch. in plastica, non ventilato Cap ø65 male screw ø43,6 x 6 for plastic filler neck, non vented		
					
CITROËN Jumper 94 ▶ 98 FIAT Croma 87 ▶ 2/97 Ducato 94 ▶ 98 Punto, Punto Team ▶ 97 LANCIA Delta - Prisma 87 ▶ 93 Thema 87 ▶ 94 PEUGEOT Boxer 94 ▶ 06			LADA Samara - 2108 - 2109 - 21081 - 21093 Samara Cabrio MAZDA Spider MX3 94 ▶		
067775 - 0QD482 023317			067783 - 0QD599 023343		
Tappo ø77,5 filettato femmina ø62,5 x 6,3, non ventilato Cap ø77,5 female screw ø62,5 x 6,3, non vented			Tappo ø73 a vite femmina ø62,5 p.6,35 per bocch. in plastica, non ventilato Cap ø73 screw female ø62,5 x 6,35 for plastic filler neck, non vented		
					
ALFA ROMEO 155 FIAT Fiorino 94 ▶ 11/06 Tipo - Tipo (Restyling '93) - Tempra LANCIA Dedra - Dedra familiare Delta 93 ▶ 2/96 Delta HPE escluso turbo (turbo excluded) 95 ▶			FIAT Punto D, turbodiesel, van ▶ 97		









LEGENDA

▶ Anno = fino al ...
Anno ▶ Anno = dal...al...
Anno ▶ = dal ...

KEY

▶ Year = up to ...
Year ▶ Year = from...up to..
Year ▶ = from ...

APPLICABILITA' SPECIFICHE DI OGNI TAPPO - APPLICATION BY CODE

CODICE TAPPO CON CHIAVE E SENZA CHIAVE CAP CODE WITH AND WITHOUT KEY			CODICE TAPPO CON CHIAVE E SENZA CHIAVE CAP CODE WITH AND WITHOUT KEY		
067785 - 0QD600	023343		067787	023343	
Tappo ø73 a vite femmina ø62,5 p.6,35 per bocch. in plastica, non ventilato Cap ø73 screw female ø62,5 x 6,35 for plastic filler neck, non vented			Tappo ø77 filettato femmina ø62,5 x 6,35, non ventilato Cap female screw ø62,5 x 6,35, non vented		
 			 		
FIAT Punto, Punto Team	▶ 97		FIAT Brava Diesel Bravo Diesel Croma Diesel Marea Diesel	▶ 6/98 ▶ 6/98 87 ▶ 2/97 ▶ 6/98	
LANCIA Y	▶ 97		LANCIA Delta Diesel Prisma - Thema Diesel	87 ▶ 87 ▶ 94	
067786 - 0QD608	023338				
Tappo ø77,5 a vite femmina ø62,5 p.6,35 per bocch. In plastica, ventilato con valvola Cap ø77,5 screw female ø62,5 x 6,35 for plastic filler neck, vented by venting system					
 					
ALFA ROMEO 145, 146	▶ 98				
FIAT Bravo - Brava Marea berl. e sw.	▶ 6/98 ▶ 6/98				
LANCIA Delta Delta HPE 2000 Turbo	3/96 ▶ 00 3/95 ▶				

LEGENDA

▶ Anno = fino al ...
Anno ▶ Anno = dal...al...
Anno ▶ = dal ...

KEY

▶ Year = up to ...
Year ▶ Year = from..up to..
Year ▶ = from ...

APPLICABILITA' SPECIFICHE DI OGNI TAPPO - APPLICATION BY CODE

CODICE TAPPO CON CHIAVE E SENZA CHIAVE CAP CODE WITH AND WITHOUT KEY			CODICE TAPPO CON CHIAVE E SENZA CHIAVE CAP CODE WITH AND WITHOUT KEY		
067802 - 0QD656			023354		
<p>Tappo ø81 con filetto speciale ø44,6 p.6 per bocchettone in plastica, ventilato con valvola Cap ø81 with special screw ø44,6 x 6 for plastic filler neck, vented by venting system</p>			<p><i>Prosegue - Continued</i> 067802 - 023354</p>		
			<p>LAND ROVER</p> <p>Discovery 7/09 ▶</p> <p>Freelander 12/06 ▶</p> <p>Range Rover 6/07 ▶</p> <p>Range Rover Evoque 6/11 ▶</p> <p>Range Rover Sport 6/07 ▶</p> <p>Range Rover Velar 5/17 ▶</p>		
<p>CHRYSLER</p> <p>Grand Voyager 99 ▶ 1/11</p> <p>PT Cruiser 00 ▶ 10</p> <p>Voyager 99 ▶ 08</p>			<p>MERCEDES</p> <p>Classe GL 06 ▶ 3/16</p> <p>Classe ML 3/05 ▶</p>		
<p>DODGE</p> <p>Caliper ▶ 2/11</p> <p>Journey ▶ 2/11</p> <p>Nitro ▶ 2/11</p>			<p>VOLVO</p> <p>C30 12/06 ▶ 6/13</p> <p>S40 1/10 ▶</p> <p>V50 03/04 ▶</p>		
<p>FIAT</p> <p>Freemont 5/11 ▶ 11/16</p>			<p>067909 - 0QD516</p> <p>Tappo a vite con chiave ø93,5 per bocch. In metallo M56,3 x 2, non ventilato Locking cap screw ø93,5 for metal filler neck M56,3 x 2, non vented</p>		
<p>FORD</p> <p>C-Max 5/07 ▶ 10/10</p> <p>Focus Berlina e S.W. 12/04 ▶ 1/08</p> <p>Focus Cabrio 4/07 ▶ 2/11</p> <p>Galaxy 8/06 ▶ 2/10</p> <p>S-Max 7/06 ▶ 2/10</p>					
<p>JAGUAR</p> <p>E-Type 7/17 ▶</p> <p>F-Pace 1/16 ▶</p> <p>F-Type 4/13 ▶</p> <p>XE 1/15 ▶</p> <p>XF 12/07 ▶</p> <p>XJ 1/10 ▶</p> <p>XK Cabrio 5/06 ▶</p> <p>XK Coupè 5/06 ▶</p>			<p>SKODA</p> <p>105 S - 105 L - 120 L - 120 LS - 130 L</p>		
<p>JEEP</p> <p>Cherokee 99 ▶ 5/14</p> <p>Compass 06 ▶</p> <p>Patriot ▶ 11/11</p> <p>Wrangler 06/09 ▶</p>					
<p>LANCIA</p> <p>Flavia 06/12 ▶</p> <p>Voyager 06/12 ▶ 3/15</p>					
<i>Continua - To be continued</i>					





LEGENDA

▶ Anno = fino al ...
 Anno ▶ Anno = dal...al...
 Anno ▶ = dal ...

KEY

▶ Year = up to ...
 Year ▶ Year = from..up to..
 Year ▶ = from ...

APPLICABILITA' SPECIFICHE DI OGNI TAPPO - APPLICATION BY CODE

CODICE TAPPO CON CHIAVE E SENZA CHIAVE CAP CODE WITH AND WITHOUT KEY			CODICE TAPPO CON CHIAVE E SENZA CHIAVE CAP CODE WITH AND WITHOUT KEY		
067921 - 0QD601	023351		067922 - 0QD592	023466	
Tappo ø81 a vite femmina ø68,8 p.6 per bocch. in plastica, non vented Cap ø81 screw female ø68,8 x 6 for plastic filler neck, non vented			Tappo ø96 a vite femmina per bocch. In metallo M80 x 2,ventilato Cap ø96 screw female for metal filler neck M80 x 2, vented		
					
CITROËN			FIAT		
Evasion			Autocarri (con bocch.M80x2)		▶ 73
Xantia			Trucks (filler neck M80x2)		
XM					
FIAT			INTERNATIONAL		
Ulysse		▶ 6/02	Autocarri (con bocch.M80x2)		
			Trucks (filler neck M80x2)		
LANCIA			IVECO		
Z		9/94 ▶ 98	Autocarri (con bocch. M80x2) Trucks (filler neck M80x2)		▶ 73
PEUGEOT			OM IVECO		
306 3-5 porte (3 and 5 door)		94 ▶	Autocarri escluso 330 (con bocch. M80x2)	Trucks	▶ 73
405			330 excluded (filler neck M80x2)		
605					
806					



LEGENDA

▶ Anno = fino al ...
Anno ▶ Anno = dal...al...
Anno ▶ = dal ...

KEY

▶ Year = up to ...
Year ▶ Year = from..up to..
Year ▶ = from ...

APPLICABILITA' SPECIFICHE DI OGNI TAPPO - APPLICATION BY CODE

CODICE TAPPO CON CHIAVE E SENZA CHIAVE CAP CODE WITH AND WITHOUT KEY			CODICE TAPPO CON CHIAVE E SENZA CHIAVE CAP CODE WITH AND WITHOUT KEY		
067924 - 0QD621 023418			067925 - 0QD623 023439		
Tappo a vite ø103 per bocch. In plastica M65 x 6,5, ventilato con valvola Cap screw ø103 for plastic filler neck M65 x 6,5, vented by venting system			Tappo a vite ø103 per bocch. In plastica M65 x 6,5, non ventilato Cap screw ø103 for plastic filler neck M65 x 6,5, non vented		
					
IVECO Autocarri (con bocch. ø65 p.6,5 plastica) Trucks (plastic filler neck ø65 p.6,5) Daily City Eurocargo Tector 60 → 180		03 ▶ 03 ▶ 03 ▶	SCANIA Autocarri Serie 4 (trucks series 4) Autocarri con p.t.t. oltre 3,5T fino a 26T a 3 assi Trucks with capacity over 3,5T up to 26T with 3 axis: R380 Lb, R40 Lb, R500 Lb, R620 Lb Autoarticolati con p.t.t. oltre 44T Trucks with capacity over 44T: R420 La, R480 La, R500 La, R620 La Autotelai cabinati 4x2 da 12,1 a 18 t: Trucks cabin cruiser 4x2 with capacity over 12,1T up to 18T: P230 Db 14,5, P230 Db 16,5, P230 Db 18, P280 Db, P320 Db, P360 Db, R360 Lb, R380 Lb, R400 Lb, R420 Lb, R440 Lb, R480 Lb, R500 Lb, R560 Lb, R620 Lb Autotelai cabinati a 3 e 4 assi Trucks cabin cruiser with 3 or 4 axis: P280 Db 6x2*4, P320 Db 6x2*4, P360 Db 6x2*4, R360 Lb 6x2*4, R380 Lb 6x2*4, R400 Lb 6x2*4, R420 Lb 6x2*4, R440 Lb 6x2*4, R480 Lb 6x2*4, R500 Lb 6x2*4, R560 Lb 6x2*4, R620 Lb 6x2*4, R360 Lb 8x2*4, R380 Lb 8x2*4, R400 Lb 8x2*4, R420 Lb 8x2*4, R440 Lb 8x2*4, R480 Lb 8x2*4, R500 Lb 8x2*4, R560 Lb 8x2*4, R620 Lb 8x2*4 Trattori a 2 o 3 assi Tractor with 3 or 4 axis: R360 La, R380 La, R400 La, R420 La, R440 La, R480 La, R500 La, R560 La, R620La Serie G - L - P - R - S Euro6		98 ▶
067928 023400					
Tappo a vite ø103 per bocch. In plastica M80 x 6, ventilato con valvola Cap screw ø103 for plastic filler neck M80 x 6, vented by venting system					
					
IVECO Autocarri (con bocch. 80 p.6 plastica) Trucks (plastic filler neck 80 p.6) Daily City Daily, Turbodayly Eurocargo Tector 60 → 180 E		▶ 02 6/91 ▶ 98 ▶ 02 ▶ 02			

LEGENDA

▶ Anno = fino al ...
Anno ▶ Anno = dal...al...
Anno ▶ = dal ...

KEY

▶ Year = up to ...
Year ▶ Year = from...up to..
Year ▶ = from ...

ELENCO MARCHE E MODELLI DI VETTURA - Car makes and models

MARCA E MODELLO DI VETTURA Car makes / models	DAL....AL.... FROM.....TO...	CODICE Part number
ALFA ROMEO		
4C	12/2013 ▶ now	00085300
CITROËN		
C4 Picasso	2007 ▶ 12/2013	00085400
C4 Picasso	01/2014 ▶ 08/2016	00085100
DS4	03/2015 ▶ now	00085100
FIAT		
500 L	2012 ▶ now	00084900
500 Living	2013 ▶ now	00084900
Panda	10/2012 ▶ now	00084900
Tipo	01/2016 ▶ now	00084900
FORD		
B-Max	2012 ▶ 2016	00085300
C-Max	06/2015 ▶ now	00085000
Eco Sport	12/2015 ▶ now	00085000
Focus III	01/2011 ▶ 11/2014	00085300
Galaxy	2015 ▶ now	00085600
Ka +	08/2016 ▶ now	00085000
Mondeo	2014 ▶ now	00085600
S-Max	08/2015 ▶ now	00085600
Tourneo Courier	2013 ▶ now	00085000
Transit Courier	2014 ▶ now	00085300
Transit Custom	2013 ▶ now	00085300
Transit Van	2014 ▶ now	00085300
JEEP		
Gran Cherokee	2011 ▶ now	00085300
Renegade	10/2014 ▶ now	00084900
RENAULT		
Espace	2015 ▶ now	00085200
Megane	03/2016 ▶ now	00085200
Scenic	05/2009 ▶ 11/2016	00085500
	11/2016 ▶ now	00085200
Talisman	01/2016 ▶ now	00085200
VOLVO		
XC60	05/2017 ▶ now	00085000
XC90	01/2015 ▶ now	00085000

APPLICABILITA' SPECIFICHE DI OGNI KIT - Application by code

00084900

Ghiera con 3 viti e tappo con chiave ventilato
Adapter with 3 screws and locking vented cap



FIAT
500 L
500 Living
Panda
Tipo (occorre rimuovere la cuffia di gomma dallo sportellino)
(Remove the rubber cap from the flap)

12 ▶
13 ▶
10/12 ▶
1/16 ▶



JEEP
Renegade

10/14 ▶

00085000

Ghiera con 3 viti e tappo con chiave ventilato
Adapter with 3 screws and locking vented cap



FIAT
C-Max
Eco Sport
Ka +
Torneo Courier

6/15 ▶
12/15 ▶
8/16 ▶
13 ▶

VOLVO
XC60
XC90

5/17 ▶
1/15

00085100

Ghiera con 3 viti e tappo con chiave ventilato
Adapter with 3 screws and locking vented cap



CITROEN
C4 Picasso
DS4

1/14 ▶ 8/16
3/15 ▶

APPLICABILITA' SPECIFICHE DI OGNI KIT - Application by code

00085200

Ghiera con 3 viti e tappo con chiave ventilato
Adapter with 3 screws and locking vented cap



RENAULT

- Megane 3/16 ▶
- Talisman 1/16 ▶
- Scenic (occorre rimuovere la cuffia di gomma dallo sportellino)
(Remove the rubber cap from the flap) 11/16 ▶
- Espace (occorre rimuovere la cuffia di gomma dallo sportellino)
(Remove the rubber cap from the flap) 15 ▶



00085300

Ghiera con 3 viti e tappo con chiave ventilato
Adapter with 3 screws and locking vented cap



ALFA ROMEO

- 4C (occorre rimuovere la cuffia di gomma dallo sportellino)
(Remove the rubber cap from the flap) 12/13 ▶

FORD

- B-Max 12 ▶ 16
- Focus III 1/11 ▶ 11/14
- Transit Courier 14
- Transit Custom 13
- Transit Van 14

JEEP

- Gran Cherokee 11 ▶
- (occorre sfilare l'anello in plastica, prima di montare la nostra ghiera)
(Remove the plastic ring, before mounting the adapter)



APPLICABILITA' SPECIFICHE DI OGNI KIT - Application by code

00085400

Ghiera con 3 viti e tappo con chiave ventilato
Adapter with 3 screws and locking vented cap



CITROEN

C4 Picasso (occorre rimuovere la cuffia di gomma dallo sportellino)
(Remove the rubber cap from the flap)

07 ▶ 12/13



00085500

Ghiera con 3 viti e tappo con chiave ventilato
Adapter with 3 screws and locking vented cap



RENAULT

Scenic

5/09 ▶ 11/16

00085600

Ghiera con 3 viti e tappo con chiave ventilato
Adapter with 3 screws and locking vented cap



FORD

Galaxy
Mondeo
S-Max

15 ▶
14 ▶
8/15 ▶

VOLVO

XC60

5/17 ▶



TAPPI PER SERBATOI UREA (AdBlue)

FILLER CAPS FOR UREA (AdBlue) TANKS

CARATTERISTICHE:

- Materiali resistenti alla corrosione dell'urea
- Disponibile nelle versioni con chiave o senza chiave
- Ventilato / Non Ventilato

FEATURES:

- All components resistant against urea corrosion
- Available in two models, locking and non locking
- Vented / Non Vented











APPLICABILITA' SPECIFICHE DI OGNI TAPPO - APPLICATION BY CODE

CODICE TAPPO CON CHIAVE E SENZA CHIAVE CAP CODE WITH AND WITHOUT KEY			CODICE TAPPO CON CHIAVE E SENZA CHIAVE CAP CODE WITH AND WITHOUT KEY		
065529	025457		065548 + 000816	025444 + 000816	
Tappo ø96 per bocch. a baionetta interna ø60, non ventilato Cap ø96 for inside bayonet filler neck ø60, non vented			Tappo ø96 per bocch. a baionetta int.ø60 + adat. per serbatoio, ventilato Cap ø96 for inside bayonet filler neck ø60 + adapter for tank filler neck, vented		
					
SERBATOI UREA - UREA TANK IVECO Serbatoio AdBlue ventilato / AdBlue vented tank Models: Eurocargo, Stralis			SCANIA Serbatoio AdBlue non ventilato / AdBlue non vented tank		
065548	025444		065549	025467	
Tappo (colore blu) ø94 per bocch. a baionetta interna ø60, ventilato Cap (blue color) ø94 for inside bayonet filler neck ø60, vented			Tappo (colore blu) ø66 per bocch. a baionetta interna ø40, non ventilato Cap (blue color) ø66 for inside bayonet filler neck ø40, non ventilato		
					
RENAULT Serbatoio AdBlue non ventilato / AdBlue non vented tank			DAF Serbatoio AdBlue ventilato / AdBlue vented tank Models: CF75/85, XF105		
VOLVO Serbatoio AdBlue non ventilato / AdBlue non vented tank			MAN Serbatoio AdBlue ventilato / AdBlue vented tank		
			MERCEDES Serbatoio AdBlue ventilato / AdBlue vented tank		

LEGENDA
 V = tappo ventilato
 NV= tappo non ventilato
 Vd= ventilato in depressione
 E = tappo con dispositivo di sicurezza eco
 ▶ Anno = fino al ...
 Anno ▶ Anno = dal...al...
 Anno ▶ = dal ...

KEY
 V = vented cap
 NV= non vented cap
 Vd= vented on depressione
 E = cap with eco safety device
 ▶ Year = up to ...
 Year ▶ Year = from..up to..
 Year ▶ = from ...

APPLICABILITA' SPECIFICHE DI OGNI TAPPO - APPLICATION BY CODE

CODICE TAPPO CON CHIAVE E SENZA CHIAVE CAP CODE WITH AND WITHOUT KEY			CODICE TAPPO CON CHIAVE E SENZA CHIAVE CAP CODE WITH AND WITHOUT KEY		
065554	025476		065559	025469	
Tappo (colore blu) ø66 per bocch. a baionetta interna ø40, ventilato in depressione Cap (blue color) ø66 for inside bayonet filler neck ø40, vented on depresso			Tappo (colore blu) ø110 per bocch. a baionetta interna ø60, non ventilato Cap (blue color) ø110 for inside bayonet filler neck ø60, non vented		
					
					
DAF Serbatoio AdBlue non ventilato / AdBlue non vented tank Models: LF45-55, CF65			IVECO Eurocargo, Stralis, Trakker Euro 6		11/13 ▶
065557			065572		
Tappo (colore blu) con ch. ø94 per bocch. a baionetta int. ø46,5, non ventilato Locking cap (blue color) ø94 for inside bayonet filler neck ø46,5, non vented			Tappo (colore blu) con ch. ø94 per bocch. a baionetta int. ø46,5, non ventilato Locking cap (blue color) ø94 for inside bayonet filler neck ø46,5, non vented		
					
NISSAN Serbatoio AdBlue ventilato / AdBlue vented tank Fino a euro 5 / Up to Euro 5	▶		ISUZU Serbatoio AdBlue ventilato / AdBlue vented tank		
RENAULT Serbatoio AdBlue ventilato / AdBlue vented tank Models: Maxity	07 ▶		HINO Serbatoio AdBlue ventilato / AdBlue vented tank		





LEGENDA
V = tappo ventilato
NV= tappo non ventilato
Vd= ventilato in depressione
E = tappo con dispositivo di sicurezza eco

▶ Anno = fino al ...
Anno ▶ Anno = dal...al...
Anno ▶ = dal ...

KEY
V = vented cap
NV= non vented cap
Vd= vented on depresso
E = cap with eco safety device

▶ Year = up to ...
Year ▶ Year = from...up to..
Year ▶ = from ...

APPLICABILITA' SPECIFICHE DI OGNI TAPPO - APPLICATION BY CODE

CODICE TAPPO CON CHIAVE E SENZA CHIAVE CAP CODE WITH AND WITHOUT KEY		CODICE TAPPO CON CHIAVE E SENZA CHIAVE CAP CODE WITH AND WITHOUT KEY	
<p>065573 025467</p> <p>Tappo ø68 per bocchettone a baionetta interna ø40, non ventilato Cap ø68 for inside bayonet filler neck ø40, non vented</p> <div data-bbox="172 445 592 741" style="border: 1px solid black; padding: 5px; margin-bottom: 10px;">  </div> <div data-bbox="172 779 592 999" style="border: 1px solid black; padding: 5px;">  </div> <p>MERCEDES Serbatoio AdBlue ventilato AdBlue vented tank Actros Euro 6</p> <p>NISSAN Cabstar Adblue Tank Euro6</p>			

LEGENDA
 V = tappo ventilato
 NV= tappo non ventilato
 Vd= ventilato in depressione
 E = tappo con dispositivo di sicurezza eco

▶ Anno = fino al ...
 Anno ▶ Anno = dal...al...
 Anno ▶ = dal ...

KEY
 V = vented cap
 NV= non vented cap
 Vd= vented on depressure
 E = cap with eco safety device

▶ Year = up to ...
 Year ▶ Year = from..up to..
 Year ▶ = from ...

FARMA	NUOVA FAAB
012300	0AZ380
012302	0AZ381
012307	0AZ395
012308	0AD478
012312	0AD489
012510	0AZ382
015303	0BD451
015306	0BZ378
015308	0OD097
015310	0BZ369
015311	0BD459
015314	0BZ375
015316	0BZ388
015317	0BD454
015319	0BZ359
015324	0BD455
015330	0BD458
015338	0BZ363
015342	0BZ361
015345	0BZ385
015354	0BZ360
015359	0BD517
015363	0BD527
015365	0BD569
015371	0BD585
015373	0BD605
015375	0BD626
015377	0BD627
015379	0BD647
015381	0BD648
015383	0BD649
015505	0BD464
015506	0BZ368
015509	0BD465
015514	0BD467
015515	0BZ370
015531	0BZ427
015536	0BZ403
015539	0BZ383
015556	0BD470
015559	0BZ445
015561	0BD519
015563	0BD552
015567	0BD604
015575	0BD635
019625	0HH025

FARMA	NUOVA FAAB
019627	0HH020
019656	0HH591
019818	0HH007
019858	0HH507
019866	0BD525
019870	0HH589
065001	0KD060
065007	0KD139
065200	0KD472
065202	0KD640
065204	0KD522
065205	0BD580
065210	0KD610
065216	0KD620
065220	0KD632
065232	0KD655
065240	0KD657
065503	0KD514
065504	0KD473
065507	0BD553
065513	0KD564
065515	0BD609
065519	0BD651
065521	0BD652
065541	0BD653
067702	0QD475
067703	0QD153
067707	0QD291
067709	0QD217
067749	0QD130
067753	0QD476
067754	0QD449
067769	0QD481
067775	0QD482
067783	0QD599
067785	0QD600
067786	0QD608
067802	0QD656
067909	0QD516
067921	0QD601
067922	0QD592
067924	0QD621
067925	0QD623
067957	0QD637
067966	0QD654
068412	0AZ382

NUOVA FAAB	FARMA
0HH007	019818
0HH020	019627
0HH025	019625
0KD060	065001
0OD097	015308
0QD130	067749
0KD139	065007
0QD153	067703
0QD217	067709
0QD291	067707
0BZ359	015319
0BZ360	015354
0BZ361	015342
0BZ363	015338
0BZ368	015506
0BZ369	015310
0BZ370	015515
0BZ375	015314
0BZ378	015306
0AZ380	012300
0AZ381	012302
0AZ382	068412
0BZ383	015539
0BZ385	015345
0BZ388	015316
0AZ395	012307
0BZ403	015536
0BZ427	015531
0BZ445	015559
0QD449	067754
0BD451	015303
0BD454	015317
0BD455	015324
0BD458	015330
0BD459	015311
0BD464	015505
0BD465	015509
0BD467	015514
0BD470	015556
0KD472	065200
0KD473	065504
0QD475	067702
0QD476	067753
0AD478	012308
0QD481	067769
0QD482	067775

NUOVA FAAB	FARMA
0QD485	067779
0AD489	012312
0HH507	019858
0KD514	065503
0QD516	067909
0BD517	015359
0BD519	015561
0KD522	065204
0BD525	019866
0BD527	015363
0BD552	015563
0BD553	065507
0KD564	065513
0BD569	015365
0BD580	065205
0BD585	015371
0HH589	019870
0HH591	019656
0QD592	067922
0QD599	067783
0QD600	067785
0QD601	067921
0BD604	015567
0BD605	015373
0QD608	067786
0BD609	065515
0KD610	065210
0KD620	065216
0QD621	067924
0QD623	067925
0BD626	015375
0BD627	015377
0KD632	065220
0BD635	015575
0QD637	067957
0KD640	065202
0BD647	015379
0BD648	015381
0BD649	015383
0BD651	065519
0BD652	065521
0BD653	065541
0QD654	067966
0KD655	065232
0QD656	067802
0KD657	065240



ENIT (Italy), uffici e stabilimenti
Via Giulio Cesare, 111
40019 TUSCANO (BO) - Italia (Italy)
Codice Fiscale 00821002922 Farma S.p.A. 00821002922
Tel. +39 054 98814 - Fax. +39 054 98814
Reg. Imp. Nr. 11200 R.F.A. n. 03029 Mod. 00000000
P.le. via. s. Maria 100/101
E-mail: info@farma.org.it

ENIT (Italy), uffici e stabilimenti
Via Giulio Cesare, 111
40019 TUSCANO (BO) - Italia (Italy)
Codice Fiscale 00821002922 Farma S.p.A. 00821002922
Tel. +39 054 98814 - Fax. +39 054 98814
Reg. Imp. Nr. 11200 R.F.A. n. 03029 Mod. 00000000
P.le. via. s. Maria 100/101
E-mail: info@farma.org.it



Declaration of Conformity

**Subject: RoHS
 REACH
 Conflict Minerals**

F.A.R.M.A. Srl parts and products are compliant:

RoHS : (RoHS Annex II of Directive 2011/65/EU and Directive 2015/863/EU)

Farma Srl hereby certifies that its product comply with the EC Directive 2011/65/EU and Directive 2015/863/EU on the Restriction of Hazardous Substances commonly known as RoHS II.

REACH : (Regulation EC No.1907/2006)

Farma Srl hereby certifies that its product and do not contain any Substance of Very High Concern (SVHC) currently on the candidate List above the threshold limits defined by Article 33, or any substance restricted in Annex XVII of EU Regulation (EC) No. 1907/2006 on Registration, Authorisation, and Restriction of Chemicals (REACH).

Conflict Minerals : (Regulation (UE) 2017/821)

Farma Srl takes its responsibility as a global partner very seriously. We work with our supply chain to ensure that we maintain the policy of not supporting Conflict Minerals suppliers, by confirming whit them that their sources of raw materials, especially Tantalum, Tungsten, Tin and Gold, are not sourced from any Conflict Regions, such as Democratic Republic of Congo, or adjoining countries.



La riproduzione totale o parziale del presente catalogo è consentita solo su diretta autorizzazione scritta della F.A.R.M.A. S.R.L.

The whole or partial reproduction of the contents of this publication is allowed only under direct written authorization of the F.A.R.M.A. S.R.L.

Le descrizioni ed illustrazioni del presente catalogo si intendono fornite a semplice titolo indicativo e non impegnativo. La FARMA si riserva il diritto di modificare in qualsiasi momento la costruzione e i dati tecnici dei suoi modelli. Description and pictures on this catalogue are merely indicative. FARMA Co. reserve the right to change at all times construction and technical features of their models.

Automotive division

Plastic Injection Division

Zamak Foundry Division



Automotive Division



Zamak Foundry Division



Plastic Division



Sede legale, uffici e stabilimento:
Via Galileo Galilei, 171
40059 FOSSATONE DI MEDICINA (Bologna) ITALY
Codice Fiscale 00662650373 Partita IVA IT00520381203
Tel. +39 051 856314 - Fax. +39 051 856319
Reg. Impr. Bo n.21902 R.E.A. n.226070 Mecc. B0007428
Web site: www.farmagroup.it
Email: farma@farmagroup.it

DIVISIONE AUTOMOTIVE:
Via Galileo Galilei, 288 AC
DIVISIONE FONDERIA:
Via Galileo Galilei, 171
DIVISIONE ATTREZZERIA:
Via Galileo Galilei, 305
DIVISIONE PLASTICA:
Via Galileo Galilei, 355

